

**\* INDICATES A CHANGE TO A RULE WITH EFFECTIVE DATE**

**SD STATE PLUMBING COMMISSION  
308 S PIERRE STREET  
@ 1320 E SIOUX AVENUE  
PIERRE SD 57501  
TELEPHONE 605-773-3429  
FAX 605-773-5405**

**INFORMATION PERTAINING TO THE  
UNIFORM PLUMBING CODE**

\* 9/23/04

The 2003 edition of the Uniform Plumbing Code has been incorporated as a guide for minimum standards relative to plumbing governed under SDCL 36-25. Under SDCL 36-25-15, the Commission is empowered to amend, revoke and revise these standards. The 2003 Uniform Plumbing Code will be used as South Dakota's code in its entirety with the exception of the following sections which are hereby repealed: 102.2.1 to 103.6.3, inclusive; Table 1-1 of Chapter 1; 307.2; 308.1; 308.2; 313.7; 313.10.4; 314.7; 315.2; 315.3; 318.4; 318.6; 320.0; 412.2.1; 412.9; 413.7; 414.0; 421.0; 606.2.2; 609.5 to 609.7.2, inclusive; 710.1; 710.9; 713.3; 713.5; 714.4; 714.5; 716.0; 721.2; 722.2 to 723.0, inclusive; 802.0; 811.5; 904.2; 1016.1.2; 1101.5.1 to 1101.10, inclusive; 1101.13; 1103.1; 1103.4; Chapter 5; Chapter 12; Chapter 13; Chapter 15; E25 to E41.4 of Appendix E, inclusive; E84 of Appendix E; Appendix G; Appendix I; Appendix J; and Appendix K.

**COMMISSION MEMBERS**

Daniel Smith	605-224-1400	Pierre SD
Roger Simonsen	605-387-5183	Menno SD
James Berreth	605-437-2488	Artes SD
Daniel Hartman	605-642-5755	Spearfish SD
Clark Hepper	605-773-3364	Pierre SD

**INSPECTORS**

Jeff Leuning	Mitchell SD
James Borth	Piedmont SD
Richard Steen	Watertown SD
Robert Smith	Brandon SD
Gerald Johnson	Spearfish SD

**OFFICE STAFF**

Michael Richards Executive Director	605-773-3429 e-mail <a href="mailto:mike.richards@state.sd.us">mike.richards@state.sd.us</a>	Pierre SD
Nina Ripley Secretary	605-773-3429 e-mail <a href="mailto:nina.ripley@state.sd.us">nina.ripley@state.sd.us</a>	Pierre SD

## ARTICLE 20:54

**20:54:02:01. Conformance with uniform code -- Exceptions.** All plumbing materials and plumbing systems or parts of plumbing systems installed must meet or exceed the minimum provisions of the **Uniform Plumbing Code**, 2003 edition, including Appendix's A, B, D, E, H, and L with the following exceptions:

- \* **9/23/04** (1) Sections 102.2.1 to 103.6.3, inclusive, Table 1-1 of Chapter 1, 307.2, 308.1, 308.2, 313.7, 313.10.4, 314.7, 315.2, 315.3, 318.4, 318.6, 320.0, 412.2.1, 412.9, 413.7, 414.0, 421.0, 606.2.2, 609.5 to 609.7.2, inclusive, 710.1, 710.9, 713.3, 713.5, 714.4, 714.5, 716.0, 721.2, 722.2 to 723.0, inclusive, 802.0, 811.5, 904.2, 1016.1.2, 1101.5.1 to 1101.10, inclusive, 1101.13, 1103.1, 1103.4, Chapter 5, Chapter 12, Chapter 13, Chapter 15, E25 to E41.4 of Appendix E, inclusive, E84 of Appendix E, Appendix G, Appendix I, Appendix J, and Appendix K;
  - (2) The words "repair" or "repairs" are removed from section 101.5.1;
- \* **9/23/04** (3) The words "or within" are added after the word "into" in section 101.5.6;
  - (4) The words "except as provided for in Section 103.5.5.2" are removed from section 101.5.6;
- \* **9/23/04** (5) The words "Voids around piping passing through concrete floors on the ground shall be appropriately sealed." are removed from section 313.1;
- \* **9/23/04** (6) The words "No plumbing piping shall be directly embedded in concrete or masonry." are removed from section 313.2;
- \* **9/23/04** (7) The word "water," is removed from the first sentence of 313.6; and the words "No water piping shall be installed in an exterior wall or unheated attic. An exterior wall includes any wall between a heated space and an unheated space. Water service piping must be installed below recorded frost lines or with a minimum earth cover of 72 inches. Building sewers must be installed with a minimum earth cover of 42 inches. Building sewers on septic systems may be installed at a minimum depth of 30 inches if the length of the building sewer does not exceed 40 feet." is added to section 313.6;
  - (8) The words "Exception: See Section 1211.3.4" are removed from section 313.9;
  - (9) The words "Any penetration through fire resistive construction shall be in accordance with Section 313.7" are removed from section 313.10.3;
  - (10) The words "metal" and "securely fastened to the adjoining structure" are removed from section 313.12.3;
- \* **9/23/04** (11) The words "Plastic pipe and fittings designed to be joined by solvent cementing shall comply with appropriate IAPMO Installation Standards." are removed from section 316.1.6;
  - (12) The words "7 Piping may be supported at intervals shown in the above table or as per manufacturer's instructions" is added to the bottom of Table 3-2;



- (13) The fraction "1/10" is changed to "1/4" in section 319.1;
- (14) The word "shall" is changed to "may" in section 402.4;
- (15) The words "tubular PVC, or tubular ABS" are added after "(0.8mm)" in section 405.3;
- \* 9/23/04 (16) The words "that obstructs or retards the flow" are added after the words "flanges" in the last sentence of section 408.5;
- (17) The words "except for guest rooms in motels, hotels, dormitories, boarding houses and similar occupancies, which may be round bowls" are added after the words "elongated type" and the words "water closets shall be of a size" are changed to "water closets may be of a size" in section 409.1;
- (18) The words "Exception: Closed front seats shall be permitted in hotel and motel guest rooms, dormitories, boarding houses, and similar occupancies" are added to section 409.2.2;
- (19) The words "The floor shall slope toward the floor drains" are added to section 412.2.3;
- (20) The words "and in basements" are added to section 412.2.3;
- (21) The words "Fixtures and Fixture Fittings for Persons with Disabilities Plumbing fixtures and fixture fittings for persons with disabilities shall conform to the appropriate standards referenced in Table 14-1 of this Code" are changed to "Hot Water Supply System In residences and buildings intended for human occupancy, hot water shall be supplied to all plumbing fixtures and equipment used for bathing, washing, culinary purposes, cleansing, laundry, or building maintenance. Hot water is defined as a temperature of no less than 125 degrees nor more than 140 degrees" in section 414.0;
- (22) The words "as determined by applicable building codes" are added to the second paragraph at the top of Table 4-1;
- \* 9/23/04 (23) The words "Service sinks are required in all occupancies listed in Table 4-1 with the exception of dwellings." are added to Footnote 9 of Table 4-1;
- \* 9/23/04 (24) The words "A dual check backflow preventer which conforms to ANSI/ASSE D1024 shall be installed on the building side immediately downstream of the water meter where the water service enters the building" are added to section 602.1;
- \* 9/23/04 (25) The words "Copies of testable backflow preventer test reports for the initial installation shall be sent to the water supplier. Copies of annual testable backflow preventer test reports shall be sent to the water supplier. A testable device is a device with atmospheric vents, test ports, or both" are added to section 603.3.3;
- (26) The words "Water-to-water heat exchangers that return the water back to the public system of waterworks may not be allowed on a public water system unless approved by the Authority Having Jurisdiction" are added to section 603.4.4.1;

\* 9/23/04 (27) The words "Backflow preventers with atmospheric vents shall not be installed in pits, vaults, or similar potentially submerged locations" are added to section 603.4.15;

(28) The words "Drip pans shall be installed under storage-type water heaters to prevent tank leakage from causing property damage. Exceptions:

1. The lowest level of buildings, provided that the floor is concrete or other material that will not be damaged or deteriorated by water leakage from the tank;
2. Crawl spaces;
3. Spaces having floor drainage that will collect leakage from the tank; and
4. Locations where tank leakage will not damage the building or its contents.

Drip pans shall be watertight and constructed of corrosion-resistant materials. Metallic pans shall be 24 gauge minimum. Non-metallic pans shall be .0625 inches minimum thickness. Pans shall be not less than 1½ inches deep and shall be of sufficient size to hold the heater without interfering with drain valves, burners, controls, and any required access. High impact plastic pans shall be permitted under gas-fired water heaters where the heater is listed for zero clearance for combustible floors and the application is recommended by the pan manufacturer. Drip pans shall have drain outlets not less than 1 inch size, with indirect drain pipes extending to an approved point of discharge" are added to section 603.4.21;

(29) The words "Unless they are installed above the known groundwater table, they are installed at least 10 feet away from any sewer line or any other source of contamination, and they are installed only on seasonal-use facilities" are added to section 603.4.22;

\* 9/23/04 (30) The words "Fiberglass and ductile iron pipe" are added before the words "Asbestos-cement" and the words "outside a building" are changed to "up to the building valve" in section 604.1; and the words "Plastic piping for all potable water shall be water pressure rated for not less than 160 psi at 73 degrees F" are added to section 604.1;

(31) The words "or underground outside of a building" are removed from section 604.2;

(32) The words "This does not apply to electric water heaters" are added to section 604.11.2;

(33) The word "discharge" is changed to "inlet" in the first sentence of section 605.2;

(34) The words "Individual shutoff valves shall be installed on each plumbing fixture and each exterior hose bib. Exception: In single family dwellings, individual valves are not required on tub valves, shower valves, and exterior hose bibs" are added to section 605.5;

(35) The words "except that underground joints may not be soldered" are added to section 606.2.1;

(36) The words "the outside of the building with the end of the pipe not more than two (2) feet (610mm) nor less than six (6) inches (152mm) above the ground or the flood level of the area receiving the discharge and pointing downward" are changed to "within not more than 6 inches nor less than 2 inches above the floor" and "other approved points of disposal shall include mop sinks, floor sinks and standpipe receptors" is added to section 608.5;

(37) The words "All water service yard piping shall be at least twelve (12) inches (305mm) below the average local frost depth. The minimum cover shall be twelve (12) inches (305mm) below finish grade" are removed from section 609.1;

(38) The words "Potable water service piping shall not be located in, under, or above cesspools, septic tanks, septic tank drainage fields, or drainage pits. A separation of 25 feet shall be maintained from such systems, except for livestock confinement facilities which may be 3 feet" are added to section 609.2.2;

\* 9/23/04 (39) The words "Except for plastic piping" are removed from section 609.4;

(40) The words "Dwelling units are exempt from this requirement" are added to section 609.10;

(41) The words "The minimum size water service allowed is 1 inch except to travel trailer or mobile home sites which shall be not less than 3/4 inch" are added to section 610.1;

(42) The words "Not more than 1 fixture may be served by a 1/2 inch outlet on a manifold system" are added to section 610.4;

\* 9/23/04 (43) The words "and plastic pipe and fittings installed underground outside of buildings may be SDR 35 ASTM 3034 or heavier" are added after the word "bore," to section 701.1;

\* 9/23/04 (44) The words "ABS and PVC DWV piping installations shall be installed in accordance with IS 5, IS 9, and Chapter 15 "Firestop Protection." are removed from section 701.1.2;

(45) The words "commercial dishwashing machines" are deleted in section 704.3 and the words "commercial dishwashing machines shall be provided with indirect wastes" are added to section 704.3;

(46) The words "The top of the closet flange shall be installed above the finished floor not to exceed 3/8 inch" are added to section 704.4.3;

\* 9/23/04 (47) The words "Except sinks, urinals and dishwashers" are changed to "Except kitchen sinks, urinals and dishwashers. Bar and laundry sinks are not included in this exception." in Footnote 2 of Table 7-5;

(48) The words "not to exceed one-third (1/3) of the total permitted length of any vent may be installed in a horizontal position" are removed from "Note" under Table 7-5;

\* 9/23/04 (49) The words "Exception: 1/4 bends may be used on individual fixture drains for horizontal to vertical, horizontal to horizontal, and vertical to horizontal changes in direction." are added to section 706.1;

(50) The words "when the barrel of the fitting is at least two (2) pipe sizes larger than the largest inlet, (pipe sizes recognized for this purpose are 2", 2½", 3", 3½", 4", 4½", 5", 6", etc) (50, 65, 80, 90, 100, 115, 125, 150 mm, etc)" are removed from section 706.2; "Double or single sanitary tees with side inlet may be used if the side inlet flow line is above the flow line of the largest horizontal inlet" are added to section 706.2; and, "When a double sanitary tee is serving

back to back water closets that are less than 30 inches from the soil stack, the stack shall be 4 inches" are added to section 706.2;

(51) The words "(5) Where the piping is concealed, a fixture trap or a fixture with integral trap, readily removable without disturbing concealed roughing work, shall be accepted as a cleanout equivalent" are added to section 707.4;

(52) The words "No underfloor cleanout shall be located more than twenty (20) feet (6096mm) from an access door, trap door or crawl hole" are removed from section 707.10;

\* 9/23/04 (53) The words ", when first approved by the Authority Having Jurisdiction" are removed from section 708.0;

(54) The words "and gate valve" are removed from section 710.3.2;

(55) The words "and gate or ball valve" are removed from section 710.4;

(56) The words "Where the Administrative Authority, due to practical difficulties or hardships, finds that a water or air test cannot be performed, a smoke or peppermint test shall be substituted in lieu thereof. A smoke test shall be made by introducing into the entire system a pungent, thick smoke proceeded by one or more smoke machines. When the smoke appears at stack openings on the roof, they shall be closed and at a pressure equivalent to a one-inch water column shall be developed and maintained for the period of the inspection. A peppermint test shall be conducted by the introduction of two ounces of oil of peppermint into the roof terminal of every line or stack to be tested. The oil of peppermint shall be followed at once by 10 quarts of hot water whereupon all roof vent terminals shall be sealed. A positive test which reveals leakage shall be the detection of the odor of peppermint at any trap or other point on the system. Oil of peppermint of persons whose person or clothes have come in contact with oil of peppermint shall be excluded from the test area" are added to section 712.0;

(57) The words "except that plastic pipe shall not be tested with air" and "After the plumbing fixtures have been set and their traps filled with water, they shall be submitted to a final test" are removed from section 712.1;

(58) The words "Exception: Single family dwellings and buildings or structures accessory thereto, existing and connected to an approved private sewage disposal system prior to the time of connecting the premises to public sewer may, when no hazard, nuisance, or insanitary condition is evidenced and written permission has been obtained from the Authority Having Jurisdiction, remain connected to such properly maintained private sewage disposal system when there is insufficient grade or fall to permit drainage to the sewer by gravity" are removed from section 713.6;

(59) The words "Approved manholes may be installed in lieu of cleanouts when first approved by the Authority Having Jurisdiction. The maximum distance between manholes shall not exceed three hundred (300) feet (91.4m). The inlet and outlet connections shall be made by the use of a flexible compression joint no closer than twelve (12) inches (305mm) to, and not farther than three (3) feet (914mm) from the manhole. No flexible compression joints shall be embedded in the manhole base." are changed to "For underground piping over 7 inches, manholes shall be provided and located at every change of size, alignment, grade, or elevation and at intervals of not

more than 500 feet. When total length is less than 150 feet, cleanouts may be provided at 100 foot intervals" in section 719.6;

(60) "five (5) feet (1524mm)" is changed to "15 feet" in section 801.3;

(61) The words "No domestic dishwashing machine shall be directly connected to a drainage system or food waste disposer without the use of an approved dishwasher airgap fitting on the discharge side of the dishwashing machine. Listed airgaps shall be installed with the flood level (FL) marking at or above the flood level of the sink or drainboard, whichever is higher" are changed to "The discharge from a residential kitchen sink and dishwasher may discharge through a single 1½ inch trap. The discharge line from the dishwasher shall be not less than 1/2 inch nominal size and shall either be looped up and securely fastened to the underside of the counter or be connected to a deck-mounted dishwasher air gap fitting. The discharge shall then be connected to a wye fitting between the sink waste outlet and the trap inlet or to the disposal" in section 807.4;

(62) The words "ABS and PVC DWV piping installations shall be installed in accordance with IS 5, IS 9 and Chapter 15 "Firestop Protection for DWV and Stormwater Application" are removed from section 903.1.2;

(63) The following table is added to section 904.1:

**NOMINAL PIPE CROSS SECTIONAL AREA (SQUARE INCHES)**

Nominal Pipe Size (ID)	Cross Sectional Area (Sq In)
1 ½"	1.8
2"	3.1
2 ½"	4.9
3"	7.1
4"	12.6
5"	19.6
6"	28.3
8"	50.3
10"	78.5
12"	113.1
15"	176.7

(64) The words "Where frost or snow closure is likely to occur in locations having minimum design temperature below 0°F (-17.8°C), vent terminals shall be a minimum of two (2) inches (51mm) in diameter but in no event smaller than the required vent pipe. The change in diameter shall be made inside the building at least one (1) foot (305mm) below the roof in an insulated space and terminate not less than ten (10) inches (254mm) above the roof, or as required by the Authority Having Jurisdiction" are changed to "Each vent extension through a roof shall be at least 3 inches in diameter except kitchen sink vents in single-family dwellings, which shall be at least 2 inches in diameter. The change in diameter shall be made inside the building at least 1 foot below the roof with an approved fitting" in section 906.7;

(65) The words "Alternate island sink installations require a minimum of a 3-inch diameter drain undiminished in size which shall rise up through the sink cabinet and capped off as high as possible. The vent shall connect no further than 15 feet from the vertical section of the drain and

shall be a minimum of 1½ inch in diameter. A 3x3x1½-inch sanitary tee is required for connection to the trap" are added to section 909.0;

(66) The words "Exception: In single family dwellings the maximum length for a floor drain connected to a uniformly sized building drain vented on both the upstream and downstream side of the connection to the floor drain is 15 feet. The minimum trap seal shall be 4 inches." are added to section 910.1;

(67) The words "Exception: Up to 3 lavatories may be permitted on a 2 inch trap arm" are added to section 1001.1;

(68) The words "17 B&S Gauge" is changed to "20 B&S Gauge" and "(0.045 inch) (1.1mm)" are deleted from section 1003.1;

(69) The words "Slip joint extensions with 45 degree slip joint offsets are allowed" are added to section 1003.2;

(70) The words "The trap shall be the same size as the trap arm to which it is connected" are removed from section 1003.3;

(71) The words "The use of ladders or" are removed from section 1009.5;

\* 9/23/04 (72) The words "Floor drains in garages serving dwelling units for parking purposes that are connected to a building sanitary sewer shall have a means of collecting sediment and shall be provided with a water trap seal." are added to section 1016.2;

(73) The words "ABS and PVC DWV piping installations shall be installed in accordance with IS 5, IS 9 and Chapter 15 "Firestop Protection for DWV and Stormwater Application" are removed from section 1101.3;

(74) The words "except where a combined sewer is used, in which case the building storm drain shall be connected in the same horizontal plane through single wye fittings to the combined building sewer at least ten (10) feet (3048mm) downstream from any soil stack" are removed from section 1104.3;

(75) The words "Schedule 40 plastic DWV systems shall not be tested by the air test method" are removed from section 1109.2.2;

(76) The words "An individually vented lavatory in a single bathroom or single toilet room" is changed to "1 or 2 vented lavatories" in section L6.2.1.

\* 9/23/04 (77) The words "L 6.4 Vent Washdown. Lavatories or sinks other than kitchen sinks or food waste grinders may wash down an individual vent if not more than 2 drainage fixture units are drained to a 2-inch vent and the fixture trap arm lengths comply with Table 10-1. All fixtures shall be on the same floor level." are added after section L 6.3.

**Source:** SL 1975, ch 16, § 1; 12 SDR 91, effective December 2, 1985; 12 SDR 151, 12 SDR 155, effective July 1, 1986; 14 SDR 29, effective September 3, 1987; 15 SDR 136, effective March 15, 1989; 16 SDR 88, effective November 12, 1989; 17 SDR 75, effective December 3, 1990; 19 SDR 36, effective September 17, 1992; 20 SDR 29, effective September 1, 1993; 21 SDR 40,

effective September 4, 1994; 23 SDR 83, effective November 28, 1996; 24 SDR 19, effective August 21, 1997; 26 SDR 33, effective September 12, 1999; 29 SDR 52, effective October 20, 2002; 30 SDR 99, effective December 22, 2003; 31 SDR 35, effective September 23, 2004.

**General Authority:** SDCL 36-25-15.

**Law Implemented:** SDCL 36-25-15.

**Reference:** **Uniform Plumbing Code**, 2003 edition, pages numbered numerically, International Association of Plumbing and Mechanical Officials. Copies may be obtained from the International Association of Plumbing and Mechanical Officials, 5001 East Philadelphia Street, Ontario, CA 91761. Cost \$85.

## CHAPTER 20:54:19

### WATER CONDITIONING DEFINITIONS

Section

20:54:19:01 Definitions.

**20:54:19:01. Definitions.** Terms defined in SDCL 36-25-1 and Chapter 2 of the Uniform Plumbing Code, 2003 edition, have the same meaning when used in chapters 20:54:19 to 20:54:28, inclusive. The following terms have the meaning indicated when used in these chapters:

(1) "Administrative authority," the individual official, board, department, or agency established and authorized by a state, county, city, or other political subdivision created by law to administer and enforce the provisions of the state plumbing code as adopted or amended and the State Plumbing Commission;

(2) "Acid neutralizer," see neutralizer;

(3) "Absorption," the physical, electrostatic, surface attraction of an absorbent for molecules of a gas, liquid, dissolved or suspended substance;

(4) "Backwash filter," any filter requiring reverse flow for maintenance;

(5) "Brine," a solution of sodium chloride or salt used for regenerating water softeners;

(6) "Bypass," a connection or a valve system that allows raw water to be supplied while the water conditioner is being cleaned or serviced or the media changed;

(7) "Calcium," one of the principal elements making up the earth's crust, the compounds of which when dissolved in water make the water hard. The presence of calcium in water is a factor contributing to the formation of scale and insoluble soap curds which are means of clearly identifying hard water;

(8) "Calcium carbonate equivalent," a term used for expressing all forms of hardness and other salts in the same terms;

(9) "Capacity," expressed in total gallons of water treated, meeting the manufacturer's specifications and produced in a defined period of time;

(10) "Cartridge," removable preformed or prepackaged component containing the filter media;

(11) "Cartridge filter," a filter using a cartridge or cartridges;

(12) "Cation exchange," in water softening, principally the exchange of calcium and magnesium ions in water for sodium ions on an insoluble ion exchange material;



(13) "Color throw," the imparting of color by any part of a water softener to the effluent during any state of the operating cycle;

(13-A) "Commission," the State Plumbing Commission;

(14) "Corrosion," the attack by water on any part of a water system, causing the wasting away of metal parts;

(15) "Cubic feet," the volumetric unit used for measuring ion exchange materials, measured on an in-place, back-washed, drained, and settled condition;

(16) "Disinfection," the process of destroying harmful microorganisms, done in accordance with § 609.9 of the Uniform Plumbing Code, 2003 edition;

(17) "Distributors," devices to distribute or collect the water;

(18) "Drain line," a line used to carry backwash water, spent regenerant, and rinse water to the waste system;

(19) "Effluent," the water or solution which emerges from a water conditioner during any phase of the operating cycle;

(20) "Filter," a device installed as part of the water system through which water flows for the removal of turbidity, taste, color, or odor;

(21) "Filter area," the effective cross sectional area applicable to the surface filter media only, usually expressed in square feet;

(22) "Filter medium or filter media," see medium;

(23) "Flow rate," the quantity of water or regenerant flowing, or both, measured in gallons per minute;

(24) "Gpg," grains per gallons;

(25) "Grains per gallon," a common basis of reporting water analysis in the United States and Canada in which one grain per United States gallon equals 17.1 milligrams per liter or 17.1 parts per million and one grain per imperial gallon equals 14.3 milligrams per liter or 14.3 parts per million. One grain is 0.007 or 0.064 grams;

(26) "Gpm," gallons per minute;

(27) "Hardness," dissolved calcium and magnesium salts in water, usually expressed in grains per gallon as calcium carbonate equivalent;

(28) "Hardness leakage," calcium and magnesium present in water after passing through a water softener;

(29) "Hard water," water containing calcium and magnesium salts in concentration of one grain per gallon or more as calcium carbonate equivalent;

(30) "Installation," the piping or valving by which water conditioners are connected into the water supply system, including a drain line;

(31) "Ion exchange," a process whereby ions in solution are interchanged by a reactive material. See ion exchanger;

(32) "Ion exchanger," an insoluble reactive material capable of interchanging ions combined with the material for ions in the solution;

(33) "Iron," an element often present in ground waters in a soluble form, such as ferrous bicarbonate, in quantities usually ranging from zero to ten parts per million;

(34) "Magnesium," one of the elements making up the earth's crust, the compounds of which when dissolved in water make the water hard;

(35) "Manganese greensand," a processed, natural alumino silicate, converted to the oxidized manganese form, which is a granular material, generally used for the removal of iron or sulphides, in oxidizing filters;

(36) "Manganese zeolite," a processed natural or synthetic alumino silicate, converted to the oxidized manganese form. See manganese greensand;

(37) "Media," plural of medium;

(38) "Medium," the active material in a filter;

(39) "Micron," a linear measure of size 0.001 of a millimeter, denoted by the Greek letter symbol  $\mu$ , used in filtration work to define particle size, referring to the diameter or the largest dimension of the particle; also used to measure the size of pores, openings, or wire mesh;

(40) "Neutralizer" or "neutralizing filter," a type of filter mainly used to neutralize acidity or reduce free carbon dioxide in water;

(41) "Operating pressure," the pressure range within which equipment properly functions;

(42) "Ppm," parts per million;

(43) "Psi," pounds per square inch;

(44) "Parts per million," a common basis of reporting water analysis in the United States and Canada in which one part per million or ppm equals one pound per million pounds of water; 17.1 ppm equals one grain per United States gallon; 14.3 ppm equals one grain per imperial gallon. The metric equivalent is milligrams per liter;

(45) "pH value," a number denoting alkalinity or acidity. Numbers below seven indicate acidity, which increases as the number becomes smaller. Numbers above seven indicate alkalinity,

which increases as the number becomes larger. The pH scale runs from zero to fourteen. Seven is the neutral point;

(46) "Precoat," the application of a loose filter medium to a supporting membrane;

(47) "Pressure drop or pressure loss," a differential in pressure during flow due to frictional resistance in the system. It may be expressed in pounds per square inch or psi or feet of head of water;

(48) "Rated service flow," the manufacturer's specified maximum flow at which the conditioner will deliver water for a minimum period of 10 minutes at a pressure drop not to exceed 15 psi;

(49) "Rated softening capacity," softener capacity rating based on grains of hardness removed, as calcium carbonate, while producing soft water between successive regenerations, related to pounds of salt required for each regeneration;

(50) "Raw water," water at the inlet of the water treating unit;

(51) "Regeneration," in general, the backwash, brine, and fresh water rinse steps necessary to prepare the exchanger bed for service after exhaustion. Specifically, the "brine" step in which a sodium chloride solution is passed through the exchanger bed and the sodium ions displace the hardness ions from the exchanger to permit the hardness to be rinsed to drain. Also includes maintenance steps;

(52) "Resin," the term used to designate a synthetic organic ion exchange material such as high capacity cation exchange resin widely used in water softeners;

(53) "Rinse," that part of the cycle of a water conditioner operation where water is introduced to remove spent backwash water or regenerant, or both, prior to placing the conditioner into service;

(54) "Salt," high purity sodium chloride in a granular, rock, or briquetted form used for regenerating a water softener;

(55) "Service run," that part of the operating cycle of a water conditioner in which the raw water supply is passed through a conditioner, thereby producing quality water;

(56) "Shielded" or "insulated," the separation of metallic parts by a nonconductor;

(57) "Soft water," water containing less than one grain per gallon dissolved calcium and magnesium salts, as calcium carbonate equivalent;

(58) "Suspended matter," all undissolved material in water;

(59) "Turbidity," the term used to define any undissolved materials in water, such as finely divided particles of sand or clay;

(60) "U," see micron;

(61) "Upflow," a term applied to designate the upward direction in which water flows through the ion exchange during any phase of the operating cycle;

(62) "Water softener," a device installed as part of a water system which produces soft water by cation exchange removing calcium and magnesium or hardness from flowing water, replacing it with sodium, thereby requiring periodic regeneration with sodium chloride or salt;

(63) "Zeolite," a processed natural or synthetic alumino silicate. See also manganese greensand, manganese zeolite.

**Source:** SL 1975, ch 16, § 1; 12 SDR 91, effective December 2, 1985; 12 SDR 151, 12 SDR 155, effective July 1, 1986; 23 SDR 83, effective November 28, 1996; 29 SDR 52, effective October 20, 2002, effective December 22, 2003.

**General Authority:** SDCL 36-25-14, 36-25-15.

**Law Implemented:** SDCL 36-25-15.

**Cross-Reference:** Definitions, § 20:53:04:01.

**Reference:** **Uniform Plumbing Code, 2003 edition, International Association of Plumbing and Mechanical Officials. Copies may be obtained from the International Association of Plumbing and Mechanical Officials, 5001 East Philadelphia Street, Ontario, California 91761. Cost \$89.**

## CHAPTER 20:54:20

### WATER CONDITIONING IN GENERAL

#### Section

20:54:20:01	Conformance with code.
20:54:20:02	Repair and alterations.
20:54:20:03	Structural safety.
20:54:20:04	Repealed.
20:54:20:05	Protection of pipes.
20:54:20:06	Used or secondhand water conditioning and treatment equipment.
20:54:20:07	Condemned equipment.
20:54:20:08	Connections to plumbing system required.
20:54:20:09	Location of water conditioning and treatment equipment.
20:54:20:10	Piping measurements.
20:54:20:11	Minimum standards.

**20:54:20:01. Conformance with code.** All water conditioning and treating systems shall conform to the provisions of chapters 20:54:19 to 20:54:28, inclusive, and shall comply with all other provisions of article 20:54.

**Source:** SL 1975, ch 16, § 1; 12 SDR 91, effective December 2, 1985; 12 SDR 151, 12 SDR 155, effective July 1, 1986.

**General Authority:** SDCL 36-25-14, 36-25-15.

**Law Implemented:** SDCL 36-25-15.

**20:54:20:02. Repair and alterations.** When repairing, altering, and installing water conditioning and treatment equipment, the following standards shall be followed:

(1) In existing buildings or premises in which water conditioning and treatment equipment is to be installed, altered, repaired, or renovated, necessary deviations from the provision of this code may be permitted if such deviations conform to the intent of the code and are approved in writing by the administrative authority;

(2) When a building is moved from one location to another, no additional work or connection may be made unless the plumbing in the building has been reconstructed to comply with this article or may any additional plumbing work be installed in a building where there is defective or improperly installed plumbing until the defects have been repaired, renovated, replaced, or removed;

(3) Wherever compliance with all the provisions of this article fails to eliminate or alleviate a nuisance which may involve health or safety hazards, the owner or the owner's agent shall install additional water treatment equipment as necessary to abate the nuisance.

**Source:** SL 1975, ch 16, § 1; 12 SDR 91, effective December 2, 1985; 12 SDR 151, 12 SDR 155, effective July 1, 1986.

**General Authority:** SDCL 36-25-14, 36-25-15.

**Law Implemented:** SDCL 36-25-15.

**20:54:20:03. Structural safety.** In the process of installing or repairing any part of water conditioning or treatment equipment, the finished floors, walls, ceilings, tile work, or any other part of the building or premises which must be changed or replaced must be left in a safe structural condition in accordance with the requirements of the local administrative authority.

**Source:** SL 1975, ch 16, § 1; 12 SDR 91, effective December 2, 1985; 12 SDR 151, 12 SDR 155, effective July 1, 1986; 23 SDR 83, effective November 28, 1996.

**General Authority:** SDCL 36-25-14, 36-25-15.

**Law Implemented:** SDCL 36-25-15.

**20:54:20:04. Workmanship.** Repealed.

**Source:** SL 1975, ch 16, § 1; repealed, 4 SDR 10, effective August 28, 1977.

**20:54:20:05. Protection of pipes.** Protection requirements of pipes used in installing water conditioning and treatment equipment shall meet the following standards:

(1) Pipes passing under or through walls shall be protected from breakage. Pipes passing through or under cinder or concrete or other corrosive material shall be protected against external corrosion by protective coating, wrapping, or other means which will prevent corrosion;

(2) No structural member may be weakened or impaired by cutting, notching, or otherwise, except to the extent permitted by the administrative authority;

(3) No water pipe may be installed or permitted outside of a building or in an exterior wall unless adequate provision is made to protect the pipe from freezing.

**Source:** SL 1975, ch 16, § 1; 12 SDR 91, effective December 2, 1985; 12 SDR 151, 12 SDR 155, effective July 1, 1986.

**General Authority:** SDCL 36-25-14, 36-25-15.

**Law Implemented:** SDCL 36-25-15.

**20:54:20:06. Used or secondhand water conditioning and treatment equipment.** Used equipment or material for water conditioning and treatment purposes may not be purchased, sold, or installed unless it complies with the minimum standards set forth in this article. The equipment shall be sterilized before it is reinstalled.

**Source:** SL 1975, ch 16, § 1; 12 SDR 91, effective December 2, 1985; 12 SDR 151, 12 SDR 155, effective July 1, 1986.

**General Authority:** SDCL 36-25-14, 36-25-15.

**Law Implemented:** SDCL 36-25-15.

**20:54:20:07. Condemned equipment.** Water conditioning or treatment equipment condemned by the administrative authority because of wear, damage, defects, or sanitary hazards shall not be reused.

**Source:** SL 1975, ch 16, § 1; 12 SDR 91, effective December 2, 1985; 12 SDR 151, 12 SDR 155, effective July 1, 1986.

**General Authority:** SDCL 36-25-14, 36-25-15.

**Law Implemented:** SDCL 36-25-15.

**20:54:20:08. Connections to plumbing system required.** All water conditioning or treatment equipment, drains, appurtenances, and appliances used to receive or discharge liquid wastes or sewage shall be connected to the drainage system of the building or premises in accordance with the requirements of this article.

**Source:** SL 1975, ch 16, § 1; 12 SDR 91, effective December 2, 1985; 12 SDR 151, 12 SDR 155, effective July 1, 1986.

**General Authority:** SDCL 36-25-14, 36-25-15.

**Law Implemented:** SDCL 36-25-15.

**20:54:20:09. Location of water conditioning and treatment equipment.** Water conditioning or treatment equipment and piping necessary to install the equipment shall not be located in a manner that interferes with the normal operation of windows, doors, or other exit openings and shall not be located in a manner that makes other equipment inaccessible.

**Source:** SL 1975, ch 16, § 1; 12 SDR 91, effective December 2, 1985; 12 SDR 151, 12 SDR 155, effective July 1, 1986.

**General Authority:** SDCL 36-25-14, 36-25-15.

**Law Implemented:** SDCL 36-25-15.

**20:54:20:10. Piping measurements.** Except where otherwise specified in this article, all measurements between pipes or between pipes and walls shall be made to the center lines of the pipes when installing water conditioning and treatment equipment.

**Source:** SL 1975, ch 16, § 1; 12 SDR 91, effective December 2, 1985; 12 SDR 151, 12 SDR 155, effective July 1, 1986.

**General Authority:** SDCL 36-25-14, 36-25-15.

**Law Implemented:** SDCL 36-25-15.

**20:54:20:11. Minimum standards.** All water conditioning treatment equipment shall meet the Mandatory Referenced Standards, Table 14-1 of the Uniform Plumbing Code, 2003 edition.

**Source:** SL 1975, ch 16, § 1; 12 SDR 91, effective December 2, 1985; 12 SDR 151, 12 SDR 155, effective July 1, 1986.

**General Authority:** SDCL 36-25-14, 36-25-15.

**Law Implemented:** SDCL 36-25-15.

**Reference:** Uniform Plumbing Code, 2003 edition, International Association of Plumbing and Mechanical Officials. Copies may be obtained from the International Association of Plumbing and Mechanical Officials, 5001 East Philadelphia Street, Ontario, California 91761. Cost \$89.

## CHAPTER 20:54:21

### WATER CONDITIONING MATERIALS

#### Section

- 20:54:21:01 Materials used in installation.
- 20:54:21:02 Alternate materials and methods.
- 20:54:21:03 Approved materials.

**20:54:21:01. Materials used in installation.** Materials used in installation of water conditioning and treatment equipment must conform to Section 604.0, Materials, of the Uniform Plumbing Code, 2003 edition.

**Source:** SL 1975, ch 16, § 1; 12 SDR 91, effective December 2, 1985; 12 SDR 151, 12 SDR 155, effective July 1, 1986; 23 SDR 83, effective November 28, 1996; 29 SDR 52, effective October 20, 2002.

**General Authority:** SDCL 36-25-14, 36-25-15.

**Law Implemented:** SDCL 36-25-15.

**Reference:** Uniform Plumbing Code, the 2003 edition, International Association of Plumbing and Mechanical Officials. Copies may be obtained from the International Association of Plumbing and Mechanical Officials, 5001 East Philadelphia Street, Ontario, California 91761. Cost \$89.

**20:54:21:02. Alternate materials and methods.** Alternate materials and methods shall conform to the following standards:

(1) In existing buildings or premises in which water conditioning and treatment installations are to be altered, repaired, or renovated, the administrative authority may permit deviation from the provisions of chapters 20:54:19 to 20:54:28, inclusive, if a proposal to deviate is first submitted to

the administrative authority to determine that health and safety requirements, as they pertain to plumbing, are observed;

(2) Provisions of chapters 20:54:19 to 20:54:28, inclusive, are not intended to prevent the use of any material, device, method of assemblage or installation, fixture, or appurtenance not specifically authorized, provided the alternate has been approved by the administrative authority in accordance with this section;

(3) The administrative authority shall require sufficient evidence to be able to judge whether proposed alternates meet the requirements of chapters 20:54:19 to 20:54:28, inclusive, for safety and health.

**Source:** SL 1975, ch 16, § 1; 12 SDR 91, effective December 2, 1985; 12 SDR 151, 12 SDR 155, effective July 1, 1986.

**General Authority:** SDCL 36-25-14, 36-25-15.

**Law Implemented:** SDCL 36-25-15.

**20:54:21:03. Approved materials.** Water conditioning and treatment equipment contractors will be bound by any changes made by the administrative authority pertaining to materials used to install water conditioning and treatment equipment. All materials used in installing water conditioning and treatment equipment must conform to Section 604.0, Materials, of the Uniform Plumbing Code, 2003 edition..

**Source:** SL 1975, ch 16, § 1; 12 SDR 91, effective December 2, 1985; 12 SDR 151, 12 SDR 155, effective July 1, 1986; 23 SDR 83, effective November 28, 1996; 29 SDR 52, effective October 20, 2002.

**General Authority:** SDCL 36-25-14, 36-25-15.

**Law Implemented:** SDCL 36-25-15.

**Reference:** Uniform Plumbing Code, 2003 edition, International Association of Plumbing and Mechanical Officials. Copies may be obtained from the International Association of Plumbing and Mechanical Officials, 5001 East Philadelphia Street, Ontario, California 81761. Cost \$89.

## CHAPTER 20:54:22

### WATER CONDITIONING JOINTS

#### Section

20:54:22:01	Tightness.
20:54:22:02	Types of joints.
20:54:22:03	Use of joints.
20:54:22:04	Special joints.
20:54:22:05	Increasesers and reducers.

**20:54:22:01. Tightness.** Tightness of joints and connections in the plumbing system used in installation of water conditioning and treatment equipment shall be watertight for the pressure required by test.



**Source:** SL 1975, ch 16, § 1; 12 SDR 151, 12 SDR 155, effective July 1, 1986.

**General Authority:** SDCL 36-25-14, 36-25-15.

**Law Implemented:** SDCL 36-25-15.

**20:54:22:02. Types of joints.** Types of joints shall conform to the following standards:

(1) Threaded joints or screwed joints must conform to § 606.2.2 of the Uniform Plumbing Code, 2003 edition;

(2) Soldered or sweat joints for tubing must conform to § 606.2.1 of the Uniform Plumbing Code, 2003 edition;

(3) Flared joints for soft-copper water tubing must conform to § 606.1.1 of the Uniform Plumbing Code, 2003 edition;

(4) ABS and PVC pipe shall be joined by either threaded or solvent weld type fittings or a flexible neoprene compression gasket approved by the administrative authority. No threaded joint may be made on schedule 40 pipe. Polyethylene pipe shall be joined either by serrated insert and clamp type fittings with all clamping bands and tightening screws made of stainless steel or flared with compression fitting.

**Source:** SL 1975, ch 16, § 1; 12 SDR 91, effective December 2, 1985; 12 SDR 151, 12 SDR 155, effective July 1, 1986; 23 SDR 83, effective November 28, 1996; 29 SDR 52, effective October 20, 2002.

**General Authority:** SDCL 36-25-14, 36-25-15.

**Law Implemented:** SDCL 36-25-15.

**Reference:** Uniform Plumbing Code, 2003 edition, International Association of Plumbing and Mechanical Officials. Copies may be obtained from the International Association of Plumbing and Mechanical Officials, 5001 East Philadelphia Street, Ontario, California 91761. Cost \$89.

**20:54:22:03. Use of joints.** Joints in copper tubing above ground shall be made either by the use of brass or wrought copper water fittings sweated or soldered together or by means of compression fittings as provided in section 606.2.1 of the Uniform Plumbing Code, 2003 edition. Joints in copper tubing under ground shall be made with approved compression fittings as provided in section 606.2.1 of the Uniform Plumbing Code, 2003 edition.

**Source:** SL 1975, ch 16, § 1; 12 SDR 91, effective December 2, 1985; 12 SDR 151, 12 SDR 155, effective July 1, 1986.

**General Authority:** SDCL 36-25-14, 36-25-15.

**Law Implemented:** SDCL 36-25-15.

**Reference:** Uniform Plumbing Code, 2003 edition, International Association of Plumbing and Mechanical Officials. Copies may be obtained from the International Association of Plumbing and Mechanical Officials, 5001 East Philadelphia Street, Ontario, California 91761. Cost \$89.

**20:54:22:04. Special joints.** Joints from copper tubing to threaded pipe shall be made by the use of brass converter fittings. The joint between the copper pipe and the fitting shall be

sweated or soldered and the connection between the threaded pipe and the fitting shall be made with a standard pipe size screw joint.

**Source:** SL 1975, ch 16, § 1; 12 SDR 91, effective December 2, 1985; 12 SDR 151, 12 SDR 155, effective July 1, 1986.

**General Authority:** SDCL 36-25-14, 36-25-15.

**Law Implemented:** SDCL 36-25-15.

**20:54:22:05. Increases and reducers.** Where different sizes of pipes or pipes and fittings are to be connected, the increasers and reducers or reducing fittings shall be used between the two sizes.

**Source:** SL 1975, ch 16, § 1; 12 SDR 91, effective December 2, 1985; 12 SDR 151, 12 SDR 155, effective July 1, 1986.

**General Authority:** SDCL 36-25-14, 36-25-15.

**Law Implemented:** SDCL 36-25-15.

## CHAPTER 20:54:23

### WATER CONDITIONING HANGERS

#### Section

- 20:54:23:01 Vertical piping.
- 20:54:23:02 Horizontal piping.
- 20:54:23:03 Hangers and anchors used in installation of water conditioning and treatment equipment.
- 20:54:23:04 Strains and stresses.

**20:54:23:01. Vertical piping.** Vertical piping shall be secured at sufficiently close intervals to keep the pipe in alignment and carry the weight of the pipe and contents. Vertical piping shall conform to the following standards:

- (1) Screwed pipe shall be supported at not less than every other story height;
- (2) Copper tubing shall be supported at each story height but not more than ten-foot intervals;
- (3) Plastic pipe shall be supported at four-foot intervals.

**Source:** SL 1975, ch 16, § 1; 12 SDR 91, effective December 2, 1985; 12 SDR 151, 12 SDR 155, effective July 1, 1986.

**General Authority:** SDCL 36-25-14, 36-25-15.

**Law Implemented:** SDCL 36-25-15.

**20:54:23:02. Horizontal piping.** Horizontal piping shall be supported at sufficiently close intervals to keep it in alignment and prevent sagging. Horizontal piping shall conform to the following standards:

- (1) Steel threaded pipe which is one-inch diameter or less shall be supported at eight-foot intervals, over one-inch diameter at ten-foot intervals;

(2) Copper tubing shall be supported at approximately six-foot intervals for piping one and one-fourth inches and smaller and ten-foot intervals for piping one and one-half inches and larger;

(3) Plastic pipe shall be supported at intervals not exceeding four feet.

**Source:** SL 1975, ch 16, § 1; 12 SDR 91, effective December 2, 1985; 12 SDR 151, 12 SDR 155, effective July 1, 1986.

**General Authority:** SDCL 36-25-14, 36-25-15.

**Law Implemented:** SDCL 36-25-15.

**20:54:23:03. Hangers and anchors used in installation of water conditioning and treatment equipment.** Hangers and anchors shall be of metal or other material of sufficient strength to maintain their proportional share of the pipe alignments and prevent rattling. Hangers and anchors shall be securely attached to the building construction.

**Source:** SL 1975, ch 16, § 1; 12 SDR 151, 12 SDR 155, effective July 1, 1986.

**General Authority:** SDCL 36-25-14, 36-25-15.

**Law Implemented:** SDCL 36-25-15.

**20:54:23:04. Strains and stresses.** Piping in a water conditioning and treatment system shall be installed to prevent undue strains and stresses. Provision shall be made for expansion and contraction of piping and for structural settlement that may affect the piping.

**Source:** SL 1975, ch 16, § 1; 12 SDR 91, effective December 2, 1985; 12 SDR 151, 12 SDR 155, effective July 1, 1986.

**General Authority:** SDCL 36-25-14, 36-25-15.

**Law Implemented:** SDCL 36-25-15.

## CHAPTER 20:54:24

### WATER CONDITIONING INDIRECT WASTES

#### Section

20:54:24:01 Indirect waste piping.

20:54:24:02 Air gap.

20:54:24:03 Special wastes.

**20:54:24:01. Indirect waste piping.** Wastes from water conditioning and treatment equipment shall discharge to the building drainage system through an air gap serving the individual fixtures, devices, appliances, or apparatus.

**Source:** SL 1975, ch 16, § 1; 12 SDR 91, effective December 2, 1985; 12 SDR 151, 12 SDR 155, effective July 1, 1986.

**General Authority:** SDCL 36-25-14, 36-25-15.

**Law Implemented:** SDCL 36-25-15.

**20:54:24:02. Air gap.** The air gap between the indirect waste and the building drainage system shall be at least twice the effective diameter of the drain served. Extend the indirect waste pipe to an open, accessible slop sink, floor drain, or other suitable fixture which is properly trapped or vented. The indirect waste shall terminate a sufficient distance above the flood level rim of the receiving fixture to provide the required air gap.

**Source:** SL 1975, ch 16, § 1; 12 SDR 91, effective December 2, 1985; 12 SDR 151, 12 SDR 155, effective July 1, 1986.

**General Authority:** SDCL 36-25-14, 36-25-15.

**Law Implemented:** SDCL 36-25-15.

**20:54:24:03. Special wastes.** Special wastes treatment shall conform to the following standards:

(1) Acid and chemical indirect waste pipes shall be of materials unaffected by the discharge of such wastes;

(2) In no case may corrosive liquids, spent acids, or other harmful chemicals which might destroy or injure a drain, sewer, soil, or waste pipe or which might create noxious or toxic fumes discharge into the plumbing systems without being thoroughly diluted or neutralized by passing through a dilution or neutralizing device. The device shall be automatically provided with a sufficient intake of diluting water or neutralizing medium to make its contents noninjurious before being discharged into the soil or sewage system.

**Source:** SL 1975, ch 16, § 1; 12 SDR 91, effective December 2, 1985; 12 SDR 151, 12 SDR 155, effective July 1, 1986.

**General Authority:** SDCL 36-25-14, 36-25-15.

**Law Implemented:** SDCL 36-25-15.

## CHAPTER 20:54:25

### WATER CONDITIONING -- WATER SUPPLY

#### Section

- 20:54:25:01 Cross-connections.
- 20:54:25:02 Approval of devices.
- 20:54:25:03 Backflow.

**20:54:25:01. Cross-connections.** Potable water supply piping, water discharge outlets, backflow prevention devices, or similar equipment shall not be so located as to make possible their submergence in any contaminated or polluted liquid or substance.

**Source:** SL 1975, ch 16, § 1; 12 SDR 91, effective December 2, 1985; 12 SDR 151, 12 SDR 155, effective July 1, 1986.

**General Authority:** SDCL 36-25-14, 36-25-15.

**Law Implemented:** SDCL 36-25-15.

**20:54:25:02. Approval of devices.** Before any device for the prevention of backflow or backsiphonage is installed, it must have first been certified as meeting the requirements of Section 603.1, Approval of Devices or Assemblies, of the Uniform Plumbing Code, 2003 edition. Devices installed in a potable water supply for protection against backflow must be maintained in good working condition by the person or persons in control of the devices. The administrative authority having jurisdiction may inspect such devices and, if they are found to be ineffective or inoperative, shall require their replacement.

**Source:** SL 1975, ch 16, § 1; 12 SDR 91, effective December 2, 1985; 12 SDR 151, 12 SDR 155, effective July 1, 1986; 23 SDR 83, effective November 28, 1996; 29 SDR 52, effective October 20, 2002.

**General Authority:** SDCL 36-25-14, 36-25-15.

**Law Implemented:** SDCL 36-25-15.

**Reference:** Uniform Plumbing Code, 2003 edition, International Association of Plumbing and Mechanical Officials. Copies may be obtained from the International Association of Plumbing and Mechanical Officials, 5001 East Philadelphia Street, Ontario, California 91761. Cost \$89.

**20:54:25:03. Backflow.** The water-distributing system must be protected against backflow. Each water outlet must be protected from backflow, preferably by having the outlet end from which the water flows spaced a distance above the flood-level rim of the receptacle into which the water flows that is sufficient to provide a minimum air gap as required in Table 6-3 of the Uniform Plumbing Code, 2003 edition. If it is not possible to provide a minimum air gap, the water outlet must be equipped with an accessible backflow preventer complying with section 603.1 of the Uniform Plumbing Code, 2003 edition, installed on the discharge side of the manual control valve.

**Source:** SL 1975, ch 16, § 1; 12 SDR 91, effective December 2, 1985; 12 SDR 151, 12 SDR 155, effective July 1, 1986; 23 SDR 83, effective November 28, 1996; 29 SDR 52, effective October 20, 2002.

**General Authority:** SDCL 36-25-14, 36-25-15.

**Law Implemented:** SDCL 36-25-15.

**Reference:** Uniform Plumbing Code, 2003 edition, International Association of Plumbing and Mechanical Officials. Copies may be obtained from the International Association of Plumbing and Mechanical Officials, 5001 East Philadelphia Street, Ontario, California 91761. Cost \$89.

## CHAPTER 20:54:26

### WATER CONDITIONING EQUIPMENT

#### Section

- 20:54:26:01 Pumps and other appliances.
- 20:54:26:02 Repealed.
- 20:54:26:03 Allowance for character of water.
- 20:54:26:04 Procedure for sizing water conditioning and treatment equipment for domestic or commercial application.
- 20:54:26:05 Equipment removal and bypass.

**20:54:26:01. Pumps and other appliances.** Water pumps, tanks, filters, softeners, and all other appliances and devices shall be protected against contamination. The drains from pressure tanks, relief valves, and similar equipment shall be connected to the drainage system through an indirect waste.

**Source:** SL 1975, ch 16, § 1; 12 SDR 151, 12 SDR 155, effective July 1, 1986.

**General Authority:** SDCL 36-25-14, 36-25-15.

**Law Implemented:** SDCL 36-25-15.

**20:54:26:02. Water-distribution pipe, tubing, and fittings.** Repealed.

**Source:** SL 1975, ch 16, § 1; 12 SDR 91, repealed December 2, 1985.

**20:54:26:03. Allowance for character of water.** When selecting the material and size for water supply pipe, tubing, or fittings, due consideration shall be given to the action of the water on the exterior and interior of the pipe. No material that would produce toxic conditions in a potable water supply system may be used for piping, tubing, or fittings. No piping material that has been used for other than a potable water supply system may be reused in the potable water supply system.

**Source:** SL 1975, ch 16, § 1; 12 SDR 91, effective December 2, 1985; 12 SDR 151, 12 SDR 155, effective July 1, 1986.

**General Authority:** SDCL 36-25-14, 36-25-15.

**Law Implemented:** SDCL 36-25-15.

**20:54:26:04. Procedure for sizing water conditioning and treatment equipment for domestic or commercial application.** All pipe and fittings used for installation of water conditioning and treatment equipment for domestic and commercial applications must conform to section 604.1 of the Uniform Plumbing Code, 2003 edition. Water conditioning and treatment equipment must be provided with full flow control/bypass valves to ensure minimum pressure loss.

**Source:** SL 1975, ch 16, § 1; 12 SDR 91, effective December 2, 1985; 12 SDR 151, 12 SDR 155, effective July 1, 1986; 14 SDR 29, effective September 3, 1987; 23 SDR 83, effective November 28, 1996; 29 SDR 52, effective October 20, 2002.

**General Authority:** SDCL 36-25-14, 36-25-15.

**Law Implemented:** SDCL 36-25-15.

**Reference:** Uniform Plumbing Code, 2003 edition, International Association of Plumbing and Mechanical Officials. Copies may be obtained from the International Association of Plumbing and Mechanical Officials, 5001 East Philadelphia Street, Ontario, California 91761. Cost \$89.

**20:54:26:05. Equipment removal and bypass.** No water conditioning and treatment equipment may be removed without restoring the water supply. The piping shall be supported and drainable. A bypass shall be installed around equipment where the water conditioning and treatment contractor has relinquished control, ownership, and responsibility. Where the outlet of the equipment is the point of use, no bypass is required.

**Source:** SL 1975, ch 16, § 1; 12 SDR 91, effective December 2, 1985; 12 SDR 151, 12 SDR 155, effective July 1, 1986.

**General Authority:** SDCL 36-25-14, 36-25-15.

**Law Implemented:** SDCL 36-25-15.

## CHAPTER 20:54:27

### WATER CONDITIONING INSPECTION

#### Section

20:54:27:01	Inspections.
20:54:27:02	Repealed.
20:54:27:03	Test.
20:54:27:04	Responsibility.
20:54:27:05	Reinspection.
20:54:27:06	Violations.

**20:54:27:01. Inspections.** All water conditioning and treatment installation or alterations are subject to inspection to insure compliance with all the requirements of chapters 20:54:19 to 20:54:28, inclusive.

**Source:** SL 1975, ch 16, § 1; 12 SDR 91, effective December 2, 1985; 12 SDR 151, 12 SDR 155, effective July 1, 1986.

**General Authority:** SDCL 36-25-14, 36-25-15.

**Law Implemented:** SDCL 36-25-15.

**20:54:27:02. Notification.** Repealed.

**Source:** SL 1975, ch 16, § 1; repealed, 12 SDR 91, effective December 2, 1985.

**20:54:27:03. Test.** Upon completion of the installation of water conditioning or treatment equipment, it shall be tested and proved tight under a water pressure not less than the working pressure under which it is to be used. The water used for tests shall be obtained from a potable source of supply.

**Source:** SL 1975, ch 16, § 1; 12 SDR 91, effective December 2, 1985; 12 SDR 151, 12 SDR 155, effective July 1, 1986.

**General Authority:** SDCL 36-25-14, 36-25-15.

**Law Implemented:** SDCL 36-25-15.

**20:54:27:04. Responsibility.** The holder of a permit shall make sure that the work will stand the test prescribed.

**Source:** SL 1975, ch 16, § 1; 12 SDR 91, effective December 2, 1985; 12 SDR 151, 12 SDR 155, effective July 1, 1986.

**General Authority:** SDCL 36-25-14, 36-25-15.

**Law Implemented:** SDCL 36-25-15.

**20:54:27:05. Reinspection.** If the administrative authority finds that the work will not pass the inspection, the holder of a permit shall make necessary corrections and the work shall be resubmitted for inspection.

**Source:** SL 1975, ch 16, § 1; 12 SDR 91, effective December 2, 1985; 12 SDR 151, 12 SDR 155, effective July 1, 1986.

**General Authority:** SDCL 36-25-14, 36-25-15.

**Law Implemented:** SDCL 36-25-15.

**20:54:27:06. Violations.** Notices of violations shall be written and mailed or delivered by the administrative authority to the person responsible at the time inspection was made.

**Source:** SL 1975, ch 16, § 1; 12 SDR 151, 12 SDR 155, effective July 1, 1986.

**General Authority:** SDCL 36-25-14, 36-25-15.

**Law Implemented:** SDCL 36-25-15.

## CHAPTER 20:54:28

### PORTABLE WATER CONDITIONING UNITS

#### Section

20:54:28:01 Independent bacteriological tests.

20:54:28:02 Disinfection.

**20:54:28:01. Independent bacteriological tests.** Water conditioning contractors shall cause to be made bacteriological tests, consisting of bacteriological examination for coliform organisms, of water from water conditioning units after regeneration and rinsing. One influent and effluent test sample shall be collected once each month for every 1,000 portable exchange water conditioning units being regenerated or a minimum of one set of two samples per month. The laboratory tests shall be conducted by a private organization or by a municipal, county, or state health department laboratory.

**Source:** SL 1975, ch 16, § 1; 12 SDR 91, effective December 2, 1985; 12 SDR 151, 12 SDR 155, effective July 1, 1986.

**General Authority:** SDCL 36-25-14, 36-25-15.

**Law Implemented:** SDCL 36-25-15.

**20:54:28:02. Disinfection.** All water conditioning and treatment contractors shall maintain sanitary plant facilities and provide for complete disinfection of portable exchange water conditioning units.

**Source:** SL 1975, ch 16, § 1; 12 SDR 91, effective December 2, 1985; 12 SDR 151, 12 SDR 155, effective July 1, 1986.

**General Authority:** SDCL 36-25-14, 36-25-15.

**Law Implemented:** SDCL 36-25-15.



**USEFUL INFORMATION**

Angle of Bend	Arc of Circle
60 - degree	1/6
45 - degree	1/8
30 - degree	1/12
22 1/2 - degree	1/16
11 1/4 - degree	1/32
5 5/8 - degree	1/64

To find the length of a 45-degree offset, multiply the distance between the two parallel lines by the constant of 1.414.

For offsets that are not greater than 3 ft., the following is a good rule for 45-degree offsets, but not close enough for long offsets. Add the distance between the two parallel lines of pipe, 5 inches for each foot of such distance, and at the same rate for fractional parts of a foot. This would mean the addition of 5/12 of an inch for each inch. To be more exact, add 13/32 of an inch to each inch of distance between the two lines of pipe.

**TABLE OF PIPE OFFSET CONSTANTS**

Fitting	Angle	Constant
1/64th bend	5-5/8 degree	10.203
1/32nd bend	11-1/4 degree	5.125
1/16th bend	22-1/2 degree	2.613
1/12th bend	30 degree	2.000
1/8th bend	45 degree	1.414
1/6th bend	60 degree	1.155

The weight of one US gallon of water is 8-1/3 lb.

One cubic foot contains 7.48 gallons.

Pressure per square inch of a column of water -  $0.434 \times \text{height in ft.}$

To find the pressure in pounds per square inch at the base of a column of water - multiply the head of height in feet by .434.

To find the head when pressure per square inch is known - divide the pressure by .434.

To find the volume of any rectangular or cylindrical tank, multiply the area of the base  $\times$  height.

To find the volume of a rectangular tank, multiply length  $\times$  width  $\times$  height.

To find the volume of a cylindrical tank, multiply  $R^2 \times 3.1416 \times \text{height}$ , or  $D^2 \times .7854 \times \text{height}$ .

To find the volume of a rectangular or cylindrical tank in US gallons, when dimensions are given in inches, divide the number of cubic inches by 231.

To find the volume of a cylindrical or rectangular tank in US gallons, when dimensions are given in feet, multiply the number of cubic feet  $\times$  7.48.

To find the cubic contents of any length of pipe of any size - first find the cubic contents of one foot of the pipe, then multiply that amount by the number of feet of pipe. If these dimensions are in inches, the result will be cubic inches. If the result desired is gallons, as it generally will be, divide the result in cubic inches by 231, there being 231 cubic inches in one gallon.

A short method of finding the number of gallons in a foot of pipe of any diameter - multiply the square of the inside diameter of the pipe by .0408.

**RULE FOR ESTIMATING THE PITCH OF A PIPE**

Divide the total drop or fall of the pipe, measured in inches, by the horizontal distance between the two ends of the pipe, measured in feet. The result will give the pitch per feet in fractions of an inch.

To find the circumference of a circle, its diameter being given, multiply the diameter by 3.1416. The product will be the circumference.

To find the diameter of a circle, the circumference being known, divide the circumference by 3.1416, the quotient will be the diameter.

To find the area of a circle when the diameter is known, square the diameter, then multiply by .7854. Circumference of circle =  $3.1416 \times \text{diameter}$  area of circle =  $3.1416 \times \text{square of radius}$ .

To find the cylindrical area of a cylinder, multiply the circumference of a circle by the length of the cylinder.

To find the cubic contents of a cylinder, multiply the area of its circle by the length of the cylinder.

To change a common fraction to a decimal, divide the numerator by the denominator, and point off the right number of decimal places.

To add decimals, arrange the numbers so that all decimal points are in line, then carry out the addition as for whole numbers.

To multiply two decimals, arrange the two numbers regardless of the location of their decimal points. The multiplication of the numbers proceeds exactly as in the case of multiplying two whole numbers together. The proper location of the decimal point in the answer is determined by the following: In the product of the two numbers the decimal point should have as many numbers to the right of it as the sum of the numbers to the right of the decimal points of the two numbers that are multiplied together.

To divide two decimal numbers, divide the two numbers without regard to the two decimal points, just as in the division of two whole numbers. Subtract from the number of decimal places in the divisor, and the remainder will be the correct number of figures to the right of the decimal point in the quotient, which will be the answer required.

To change percent into a common fraction, write the number expressing the per cent as the numerator, with 100 as the denominator. Often such a fraction may be simplified by reducing it to its lowest terms.

To change a number written with a per cent sign into a decimal, omit the per cent sign and move the decimal point two places to the left.

To change a decimal to per cent, shift the decimal point two places to the right.

To change a common fraction into per cent, reduce the fraction to hundredths, omit the denominator and place the per cent sign after the numerator.

To find a required per cent of a number, multiply the number by the given per cent.

To compute interest when principal, rate and time are given, multiply the principal by the rate, and this amount by the number of years or fractional part of year.

In discounting, to get the net amount, multiply the base number or principal by the net on \$1.00 at the given discount.

In this method, the number below the line shows the number of equal parts into which the whole is divided, and is called the denominator. The number of equal parts taken is shown above the line, and is called the numerator. Accordingly, in speaking of  $\frac{3}{4}$  of a pound, the denominator, 4, shows the pound divided into four equal parts, and the numerator, 3, shows that three of these four parts are taken, or set aside for some special purpose.

A fraction can be changed to higher terms (without changing its value) by multiplying both numerator and denominator by the same number, and to lower terms (without changing its value) by dividing both numerator and denominator by the same number.

To reduce a mixed number to an improper fraction, multiply the whole number by the denominator of the fraction, add the numerator to the result, and place the result over the denominator.

To reduce two or more fractions to fractions having a common denominator, after deciding what the common denominator is to be, multiply each of the several numerators by the number of times its denominator is contained in the common denominator.

To add two or more fractions, reduce the fractions to fractions having a least common denominator. Then add the numerators of the fractions and place the sum over the common denominator. This fraction will be the answer required.

To subtract fractions, reduce them to fractions having a common denominator, then subtract the numerators, placing the remainder over the common denominator. Then, if necessary, reduce the result to its lowest terms, and in the case of an improper fraction, reduce it to a mixed number.

When mixed numbers are to be subtracted, subtract the fractions and the whole numbers separately.

When the smaller mixed number has a larger fraction than the larger mixed number, borrow 1 from the whole number of the larger mixed number, add it to its fraction, and then proceed to subtract.

When the larger number is a whole number, and the smaller is a mixed number, borrow 1 from the whole number.

In cancellation, any factor above the line may be divided (if without remainder) into any factor below the line, and any factor below the line may be divided into any factor above the line. For the answer, multiply together the numbers remaining above the line for the numerator, and the numbers remaining below the line for the denominator. If no number remains above the line, use 1.

To multiply a fraction by a fraction, multiply the numerators together for the numerator of the answer, and the denominators together for the denominators of the answer. Cancel whenever possible.

#### METHOD OF MAKING A SQUARE

1. Nail together two straight pieces of 1x2 board to form an L, as shown in the figure at right.
2. Mark off a point 3 ft. from the corner on one of the boards.
3. Mark off a point 4 ft. from the corner on the other board.
4. Cut another board exactly 5 ft. long. Line up this board with the points marked off.

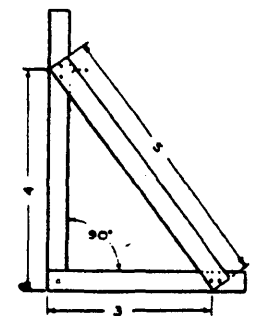

Square made from wood boards.

NOTE: The measurements can be doubled to make a larger square or they may be cut in half to make a smaller square.

**CYLINDRICAL TANKS**

Formulas:  
 C=capacity in gallons  
 D=diameter  
 L=length

When measurements are in inches:

$$C = \frac{D \times D \times .7854 \times L}{231}$$

When measurements are in feet:

$$C = D \times D \times .7854 \times L \times 7.48$$

Example: How many gallons of water will a tank hold which is 3' in diameter and 12' long?

$$C = D \times D \times .7854 \times L \times 7.48$$

$$C = 3 \times 3 \times .7854 \times 12 \times 7.48 = 634.477 \text{ or } 634\text{-}1/2 \text{ gallons}$$

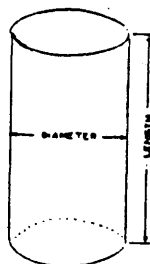

Cylindrical Tanks

**RECTANGULAR TANKS**

Formulas:  
 C=capacity in gallons  
 L=length  
 W=width  
 H=height

When measurements are in inches:

$$C = \frac{L \times W \times H}{231}$$

When measurements are in feet:

$$C = L \times W \times H \times 7.48$$

Example: How many gallons of oil will a rectangular tank hold that is 96" long, 24" wide and 12" high?

$$C = \frac{L \times W \times H}{231} = \frac{96 \times 24 \times 12}{231} = 119\text{-}3/4$$

Example: How many gallons of water will a rectangular tank hold which is 10' long, 3' wide and 5' high?

$$C = L \times W \times H \times 7.48 \quad C = 10 \times 3 \times 5 \times 7.48 = 1122$$

\*Cubic inches in one gallon  
 +Gallons per cubic foot

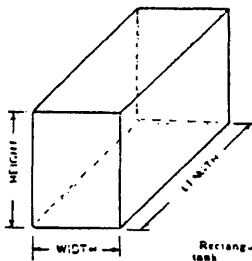

Rectangular Tanks

**MULTIPLIERS THAT ARE USEFUL TO THE TRADE**

<u>To Change</u>	<u>To</u>	<u>Multiply By</u>
Inches	Feet	0.0833
Inches	Millimeters	25.4
Feet	Inches	12
Feet	Yards	0.3333
Yards	Feet	3
Sq. Inches	Sq. Feet	0.00694
Sq. Feet	Sq. Inches	144
Sq. Feet	Sq. Yards	0.1111
Sq. Yards	Sq. Feet	9
Cubic Inches	Cubic Feet	0.00058
Cubic Feet	Cubic Inches	1728
Cubic Feet	Cubic Yards	0.03703
Cubic Yards	Cubic Feet	27
Cubic Inches	Gallons	0.00433
Cubic Feet	Gallons	7.48
Gallons	Cubic Inches	231
Gallons	Cubic Feet	0.1337
Gallons	Lbs. of Water	8.33
Lbs. of Water	Gallons	0.12004
Ounces	Pounds	0.0625
Pounds	Ounces	16
In. of Water	Lbs. Per Sq. In.	0.0361
In. of Water	In. of Mercury	0.0735
In. of Water	Oz. Per Sq. In.	0.578
In. of Water	Lbs. Per Sq. Ft.	5.2
In. of Mercury	Inches of Water	13.6
In. of Mercury	Feet of Water	1.1333
In. of Mercury	Lbs. Per Sq. In.	0.4914
Oz. Per Sq. In.	In. of Mercury	0.127
Oz. Per Sq. In.	In. of Water	1.733
Lbs. Per Sq. In.	In. of Water	27.72
Lbs. Per Sq. In.	Feet of Water	2.310
Lbs. Per Sq. In.	In. of Mercury	2.04
Lbs. Per Sq. In.	Atmospheres	0.0681
Feet of Water	Lbs. Per Sq. In.	0.434
Feet of Water	Lbs. Per Sq. In.	62.5
Feet of Water	In. of Mercury	0.8824
Atmospheres	Lbs. Per Sq. In.	14.696
Atmospheres	In. of Mercury	29.92
Atmospheres	Feet of Water	34
Long Tons	Pounds	2240
Short Tons	Pounds	2000
Short Tons	Long Tons	0.89285

LAYING OUT ANGLES WITH A SIX-FOOT RULE

Example: For a 45 degree angle, bend the rule at the first and second joints, setting the end on the marking for the angle, namely 22-31/32 in. given in the table. The desired angle will be formed as shown in the Figure.

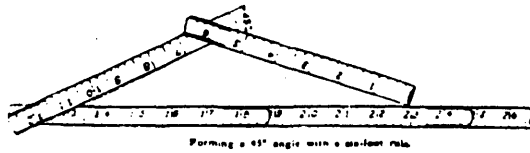

MARKINGS ON WHICH END OF RULE IS SET TO FORM VARIOUS ANGLES

Angle Degrees	Set On	Angle Degrees	Set On	Angle Degrees	Set On
5	24	30	23-1/2	60	22-1/4
10	23-15/16	35	23-3/8	65	21-15/16
15	23-7/8	40	23-9/16	70	21-11/16
20	23-25/32	45	22-11/32	75	21-3/8
22-1/2	23-11/32	50	22-3/4	80	21-1/11
25	23-5/8	55	22-1/2	90	20-9/32

DECIMAL EQUIVALENTS

Fractions of an inch	Decimals of an inch	Decimals of a foot
1/16"	.063"	.005'
1/8"	.125"	.010'
3/16"	.188"	.016'
1/4"	.250"	.021'
5/16"	.313"	.026'
3/8"	.375"	.031'
7/16"	.438"	.037'
1/2"	.500"	.042'
9/16"	.563"	.047'
5/8"	.625"	.052'
11/16"	.688"	.057'
3/4"	.750"	.063'
13/16"	.813"	.068'
7/8"	.875"	.073'
15/16"	.938"	.078'

To change a fraction of an inch to a decimal of an inch, divide the numerator by the denominator.

Example:  $3/4" = 4 \overline{)3.00}$

$$\begin{array}{r} .750 \\ 4 \overline{)3.00} \\ \underline{28} \\ 20 \\ \underline{20} \\ 0 \end{array}$$

To change a decimal of a foot to inches of a foot, multiply the decimal by 12.

Example:  $500 \times 12 = 6000 = 6"$

$$\begin{array}{r} 500 \\ \times 12 \\ \hline 1000 \\ 6000 \\ \hline 6000 = 6" \end{array}$$

To find the pressure in pounds per square inch at the base of a column of water, multiply the head or height in feet by .434.

Example:  $15' \times .434 = 6.51 \text{ lbs. or } 6-1/2 \text{ lbs.}$

To find the volume of a rectangular tank, multiply length x width x height.

Example:  $10' \times 3' \times 5' = 150 \text{ cu.ft.}$

$$\begin{array}{r} 10' \\ \times 3' \\ \hline 30' \\ \times 5' \\ \hline 150' \\ 1122.00 \text{ Gals.} \end{array}$$

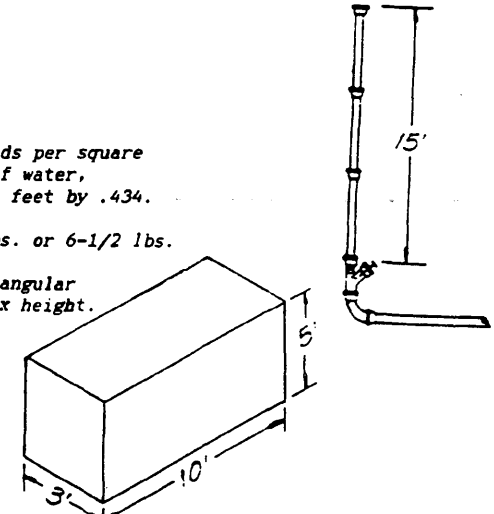

To find the volume in US Gallons, multiply the number of cubic feet x 7.48. If dimensions are given in inches, divide the number of cubic inches by 231.

$7.48 \text{ Gals.} = 1 \text{ cu.ft.}$        $231 \text{ cu.in.} = 1 \text{ gallon}$

To change a decimal of an inch to the nearest 16th, multiply the decimal by 16.

Example:  $.500 \times 16 = 8.000 = 8/16" = 1/2"$

$$\begin{array}{r} .500 \\ \times 16 \\ \hline 3000 \\ \hline 8.000 = 8/16" = 1/2" \end{array}$$

To change a fraction of an inch or a whole number to a decimal of a foot, divide by 12.

Example:  $3/4" = .75 \div 12 = .0625$  or  $.063'$        $\begin{array}{r} .0625 \\ 12 \overline{) .7500} \end{array}$        $\begin{array}{r} .75 \\ 12 \overline{) 9.00} \end{array}$

Mechanical Engineers and Architectural blueprints usually give the City sewer main and the building drain invert elevation (inside bottom of the barrel) in feet and decimals of a foot. Plumbers work with feet and inches of a foot; therefore, plumbers must change feet and decimals of a foot to feet and inches.

Example: The invert elevation at City main is given as 84.25' and the building drain is given as 86.

Total Fall =  $\begin{array}{r} 86.75' \\ 84.25' \\ \hline 2.50' = 2'6" \end{array}$        $\begin{array}{r} .50 \\ \times 12 \\ \hline 100 \\ \hline 50 \\ \hline 6.00 \end{array}$

To find the volume of a cylindrical tank, multiply  $R^2 \times 3.1416 \times \text{height}$ , or  $D^2 \times .7854 \times \text{height}$ .

Example:  $3' \times 3' \times .7854 \times 12' = 84.8232 \text{ cu.ft.}$

$$\begin{array}{r} .7854 \\ \times 9' \\ \hline 7.0686 \\ \times 12' \\ \hline 141372 \\ \hline 70686 \\ \hline 84.8232 \text{ cu.ft.} \end{array}$$

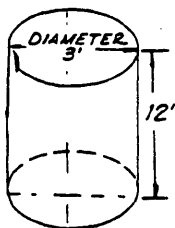

To find the volume in US Gallons, multiply the number of cubic feet by 7.48. If dimensions are given in inches, divide the number of cubic inches by 231.

7.48 Gallons = 1 cu.ft.       $\begin{array}{r} 84.8232 \text{ cu.ft.} \\ \times 7.48 \\ \hline 6785856 \\ 3392928 \\ \hline 5937624 \\ \hline 634.477536 \text{ Gals. or } 634\text{-}1/2 \text{ Gals.} \end{array}$

To find the cubic contents of any length of pipe of any size, first find the cubic contents of one foot of the pipe, then multiply that amount by the number of feet of pipe. If these dimensions are in inches, the result will be cubic inches. If the result desired is gallons, as it generally will be, divide the result in cubic inches by 231, there being 231 cubic inches in one gallon.

(See example on next page)

Example: How Many Gallons Will A 3/4" Pipe 50' Long Contain?

$\begin{array}{r} .75 \\ \times .75 \\ \hline 375 \\ 525 \\ \hline .5625 \\ \times .7854 \\ \hline 22500 \\ 28125 \\ 45000 \\ 39375 \\ \hline .44178750 \end{array}$	$\begin{array}{r} .4417875 \\ \times 12 \\ \hline 8835750 \\ 4417875 \\ \hline 5.3014500 \end{array}$	$\begin{array}{r} .022950 \\ 231 \overline{) 5.3014500} \\ \underline{462} \\ 681 \\ \underline{462} \\ 2194 \\ \underline{2079} \\ 1155 \\ \underline{1155} \\ 0 \end{array}$	$\begin{array}{r} .022950 \\ \times 50 \\ \hline 1.147500 \text{ Gals.} \end{array}$
--	---	--	--

NOTE:  $D^2 \times .7854 \times 12$   
 $3/4" = .75$

A short method of finding the number of gallons in a foot of pipe of any diameter - multiply the square of the inside diameter of the pipe by .0408.

Example: 3/4" pipe 50' long

$\begin{array}{r} .75 \\ \times .75 \\ \hline 375 \\ 525 \\ \hline .5625 \end{array}$	$\begin{array}{r} .5625 \\ \times .0408 \\ \hline 45000 \\ 225000 \\ \hline .02295000 \end{array}$	$\begin{array}{r} .02295 \\ \times 50 \\ \hline 1.14750 \text{ Gals. or } 1\text{-}5/32 \text{ Gals.} \end{array}$
---	--	--

**RULE FOR ESTIMATING THE PITCH OF A PIPE**

Divide the total drop or fall of the pipe, measured in inches, by the horizontal distance between the two ends of the pipe, measured in feet. The result will give the pitch per feet in fractions of an inch.

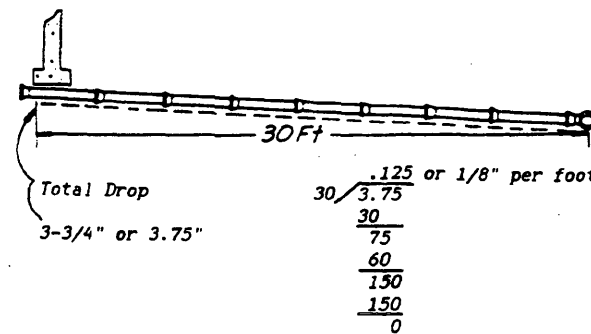

- 1/16" Pitch = 1/2% Grade
- 1/8" Pitch = 1% Grade
- 1/4" Pitch = 2% Grade
- 1/2" Pitch = 4% Grade

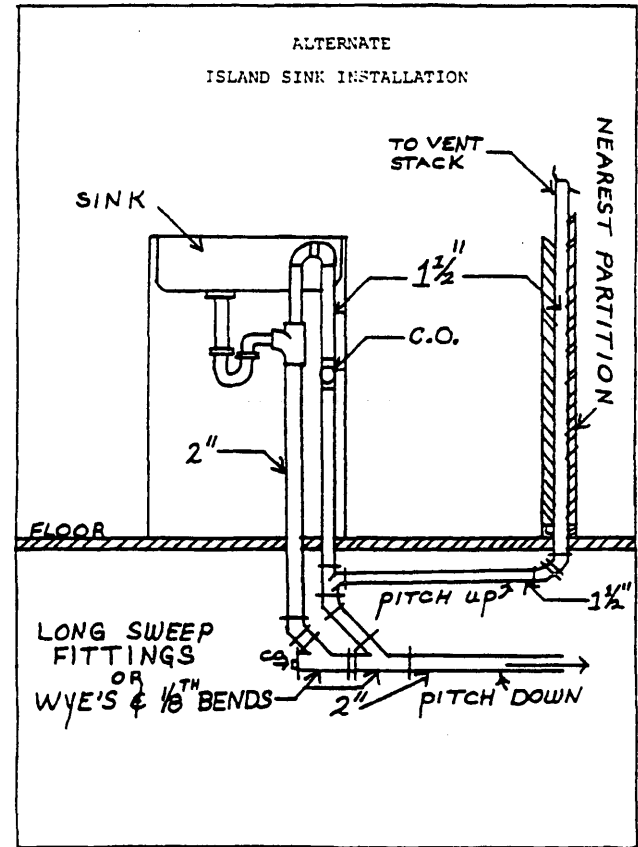
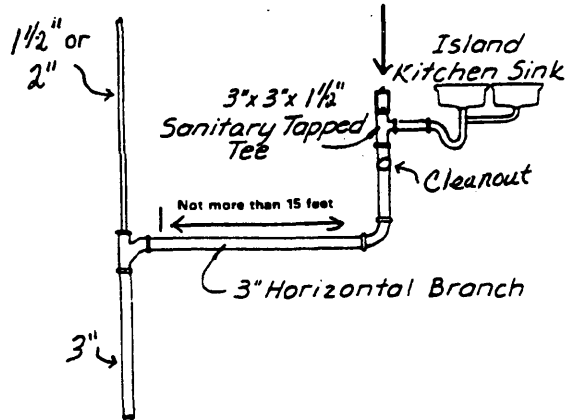
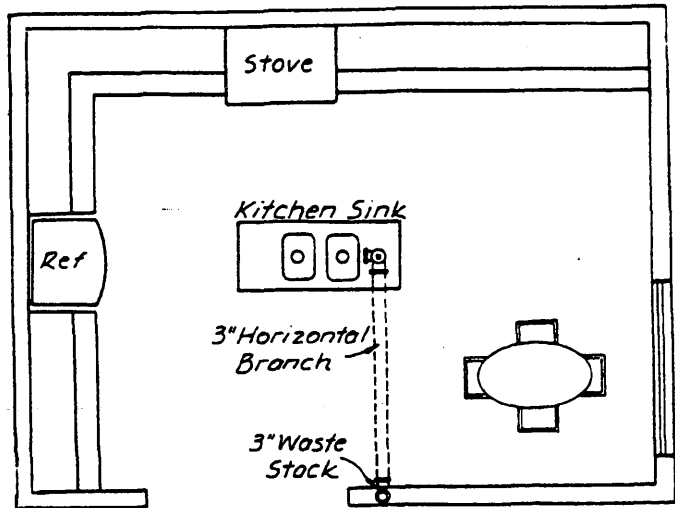

CHAPTER 25  
PLUMBERS

Section

- 36-25-1. Definition of terms.
  - 36-25-2. State plumbing commission created -- Appointment and qualifications of members.
  - 36-25-3. Terms of commission members.
  - 36-25-4. Oath of office of commission members -- Tenure.
  - 36-25-5. Vacancies on commission.
  - 36-25-6. Meetings of commission -- Quorum.
  - 36-25-6.1. Commission continued within Department of Labor -- Records and reports.
  - 36-25-7. Seal and record of proceedings -- Register.
  - 36-25-8. Officers of commission -- Terms of office.
  - 36-25-9. Bond required of secretary-treasurer.
  - 36-25-10. Employment of inspectors and assistants.
  - 36-25-11. Per diem and expenses of commission members.
  - 36-25-12. Compensation of secretary-treasurer and employees -- Other expenses.
  - 36-25-13. Disposition of moneys received.
  - 36-25-13.1. Payment of income to state treasurer -- Account in treasury -- Appropriation for expenses.
  - 36-25-14. Administration of chapter -- Promulgation of rules by commission.
  - 36-25-15. Standards adopted for plumbing -- Conformity to Uniform Plumbing Code.
  - 36-25-15.1. Scope and objectives of plumbing standards and rules.
  - 36-25-16. Local regulations permitted -- Minimum standards -- Plumbing by registrant pending municipal permit.
  - 36-25-17. License required for plumbing work on public waterworks or sewerage system -- Exceptions.
  - 36-25-17.1. Licensure without examination for certain qualified plumbers -- Time limit -- Licensure with examination thereafter.
  - 36-25-17.2. Training to be provided -- Scope and contents -- Exception.
  - 36-25-18. Commission as committee of examiners -- Duties of committee.
  - 36-25-19. Application for plumber's permit -- Examination of applicants -- Reexamination fees.
  - 36-25-19.1. Plumbing installation certificate -- Plumbing inspection -- Fees.
  - 36-25-19.2. Plumbing permit not required in certain situations.
  - 36-25-19.3. Fees for plumbing code training courses.
  - 36-25-20. Omitted.
  - 36-25-21. Reciprocity with other states.
  - 36-25-22. Registration and issuance of permit -- Expiration and renewal -- Renewal of license fees.
  - 36-25-22.1. Registration without examination.
  - 36-25-23. Temporary permits.
  - 36-25-24. Fees for permits, initial examination and license, and temporary license.
  - 36-25-24.1. "Underground irrigation" defined.
  - 36-25-25. Disposition of fees.
  - 36-25-26. Notice to commission of change of address.
  - 36-25-27. Revocation of permit -- Grounds.
- 
- 36-25-28. Procedure for revocation of permit.
  - 36-25-29. Omitted.
  - 36-25-30. Violation of chapter as misdemeanor.

36-25-31. Injunction to prevent violations -- Election of remedies.

---

36-25-1. Definition of terms. Terms used in this chapter mean:

- (1) "Commission," the State Plumbing Commission created by this chapter;
- (2) "Plumber," any person other than a plumbing contractor who, as that person's principal occupation, is engaged as an employee of, or otherwise working under, the direction of a plumbing contractor in the installation of plumbing, and who is lawfully qualified and registered as a plumber pursuant to the provisions of this chapter;
- (3) "Plumber's apprentice," any person other than a plumber or plumbing contractor who is engaged in working as an employee of a plumbing contractor under the immediate and personal supervision of either a plumbing contractor or plumber in learning and assisting in the installation of plumbing;
- (4) "Plumbing," the practice of, and the furnishing and the use of materials and fixtures in the installation, extension, and alteration of all piping, fixtures, appliances, and appurtenances in connection with sanitary drainage or storm drainage facilities, the venting system and the public water supply systems, within or adjacent to any building, structure, or conveyance. The term includes the installation, extension, or alterations of the storm-water, liquid waste, or sewerage and water-supply systems of any premises to their connection with any point of public disposal, or other regulated terminal;
- (5) "Plumbing contractor," any person qualified and skilled in the planning, superintending, and the practical installation of plumbing, and otherwise qualified and registered to contract for plumbing installations and conduct the business of plumbing, and familiar with the laws and rules governing plumbing;
- (6) "Plumbing installation certificate," the certificate issued for each installation or occurrence by the commission that authorizes a person to perform plumbing;
- (7) "Plumbing repair work," repairs to keep plumbing in an existing state including repair and replacement of faucets, valves in existing systems, repair of leaks in existing water and waste systems, replacement of damaged water closet and lavatory fixtures if it does not involve changes in rough-in, replacement of temperature and pressure relief valves on existing systems, or cleaning of sewer lines. Plumbing repair work does not include cutting into or extending water or waste lines or rough-in for new plumbing work of any kind.

---

36-25-2. State Plumbing Commission created -- Appointment and qualifications of members. There is created a State Plumbing Commission which shall perform all functions exercised by the former State Plumbing Board. The commission shall be composed of five members who shall be appointed by the Governor. The members shall not be all of the same political party. One member shall be a plumber, one a plumbing contractor, one a representative of the State Department of Health, and two shall be lay persons. Each member shall be a resident of this state.

---

36-25-3. Terms of commission members. Members of the State Plumbing Commission shall be appointed for terms of four years. The terms of the members who are first appointed after April 14, 1980, shall be: two appointed for a term of one year; two appointed for a term of two years; and one appointed for a term of four years, and such initial terms shall be designated by the Governor. Any member appointed to fill a vacancy arising from other than the natural expiration of a term shall serve for only the unexpired portion of the term.



---

36-25-4. Oath of office of commission members -- Tenure. Members of the commission shall qualify by taking and subscribing the oath of office required by other state officers, which shall be filed in the Office of the Secretary of State. Each member shall hold office until his successor is appointed and qualified.

---

36-25-5. Vacancies on commission. In the event of a vacancy on the commission for any reason, the Governor shall appoint a member to fill the unexpired term of the vacancy.

---

36-25-6. Meetings of commission -- Quorum. The commission shall meet quarterly at such time and place within this state as shall be designated by the commission. A majority of the members of the commission shall constitute a quorum for the transaction of business.

---

36-25-6.1. Commission continued within Department of Labor -- Records and reports. The State Plumbing Commission shall continue within the Department of Labor, and shall retain all its prescribed functions, including administrative functions. The commission shall submit such records, information, and reports in the form and at such times as required by the secretary of labor, except that the commission shall report at least annually.

---

36-25-7. Seal and record of proceedings -- Register. The commission shall have a common seal and shall keep a record of its proceedings, including a register which shall show the action taken by the commission on all applications for permits.

---

36-25-8. Officers of commission -- Terms of office. The members of the commission shall, within thirty days after their appointment, meet and elect a president and vice-president from their own number, and elect or appoint a secretary-treasurer who need not be one of their number, each of whom shall hold their respective office for a term of one year and until their successors are elected and qualified.

---

36-25-9. Bond required of secretary-treasurer. The secretary-treasurer shall give a bond in such sum as may be fixed by the commission, with sufficient sureties to be approved by the commission, for the faithful discharge of his duties.

---

36-25-10. Employment of inspectors and assistants. The commission is authorized to employ, in accordance with chapter 3-6A, such inspectors and assistants as may be necessary.

---

36-25-11. Per diem and expenses of commission members. Repealed by SL 1971, ch 23, § 2.

---

36-25-12. Compensation of secretary-treasurer and employees -- Other expenses. The Bureau of Personnel shall set the compensation of the secretary-treasurer, and of such other inspectors and assistants as may be necessary to carry out the provisions of this chapter, and the State Plumbing Commission may incur such other expense as may be necessary.

---

36-25-13. Disposition of moneys received. Repealed by SL 1978, ch 277, § 2.

---

36-25-13.1. Payment of income to state treasurer -- Account in treasury -- Appropriation for expenses. All moneys coming into the custody of the State Plumbing Commission each calendar month shall be paid by the commission to the state treasurer on or before the tenth day of the next month. The state treasurer shall credit the moneys to the State Plumbing Commission fund of the state treasurer, which account is hereby created. The moneys in the said State Plumbing Commission fund are for the purpose of paying the expense of administering and enforcing the provisions of this chapter, provided the total expense incurred shall not exceed the total moneys collected by the commission under the provisions of this chapter.

---

36-25-14. Administration of chapter -- Promulgation of rules by commission. The State Plumbing Commission shall administer the provisions of this chapter and may, in compliance with chapter 1-26, promulgate rules establishing the educational, training, and examination requirements required of applicants for a plumbing contractor's license, plumber's license, plumber's apprentice license, water conditioning plumbing contractor's license, water conditioning plumbing installer's license, water conditioning plumbing apprentice license, appliance plumbing contractor's license, appliance plumbing installer's license, appliance plumbing apprentice license, sewer and water plumbing contractor's license, sewer and water plumbing installer's license, sewer and water plumbing apprentice license, manufactured and mobile home contractor's license, manufactured and mobile home installer's license, manufactured and mobile home apprentice license, underground irrigation contractor's license, underground irrigation installer's license and underground irrigation installer apprentice license.

---

36-25-15. Standards adopted for plumbing -- Conformity to Uniform Plumbing Code. The commission shall, in compliance with chapter 1-26, adopt and publish minimum standards relative to the design, construction, installation, improvement, extension, and alteration of materials, piping, venting, fixtures, appliances, and appurtenances in relation to plumbing and plumbing systems. All plumbing and plumbing systems shall be designed, constructed, installed, improved, extended, and altered in substantial accord with the requirements of the 2003 Uniform Plumbing Code, International Association of Plumbing and Mechanical Officials, as in effect January 1, 2003, and such amendments or revision adopted by the commission to protect the health, life, safety, and welfare of persons and property in this state.

---

36-25-15.1. Scope and objectives of plumbing standards and rules. It is the intent of the Legislature that the rules promulgated pursuant to this chapter, in compliance with chapter 1-26, shall include the following requirements and the plumbing commission shall exercise no greater authority than is necessary for the fulfillment of this chapter:

- (1) Plumbing fixtures, devices, and appurtenances shall be supplied with water in sufficient volume and at pressures adequate to enable them to function properly and without undue noise under normal conditions of use;
- (2) Plumbing shall be designed and adjusted to use the minimum quantity of water consistent with proper performance and cleaning;
- (3) Devices for heating and storing water shall be so designed and installed as to guard against dangers from explosion or overheating;
- (4) Drainage systems shall be designed, constructed and maintained to guard against fouling, deposit of solids and clogging, and with adequate clean-outs so arranged that the pipes may be readily cleaned;
- (5) Plumbing materials shall be made of durable, smooth, nonadsorbent and corrosion resistant material, be free from concealed fouling surfaces and shall be free from defective workmanship and so designed and constructed as to give satisfactory service for its reasonable expected life;
- (6) Each fixture directly connected to the drainage system shall be equipped with a liquid seal trap;
- (7) Drainage systems shall be designed to provide an adequate circulation of air in all pipes with no danger of siphonage, aspiration, or forcing of trap seals under conditions of ordinary use;
- (8) Vent terminals shall extend to the outer air and be so installed as to minimize the possibilities of clogging and the return of foul air to the building;
- (9) Plumbing systems shall be subjected to such tests as will effectively disclose all leaks and defects in the work or the material;
- (10) No design for a plumbing system shall permit the entry into the system of any material that will clog or accentuate clogging of pipes, produce explosive mixtures, destroy the pipes or their joints, or interfere unduly with the sewage-disposal process as it enters the building drainage system;
- (11) Proper protection shall be provided to prevent contamination of food, water, sterile goods and similar materials. When necessary, the fixture, device or appliance shall be connected indirectly with the building drainage system;
- (12) Where a plumbing drainage system is subject to backflow of sewage from the public sewer, suitable provision shall be made to prevent its overflow in the building;
- (13) All plumbing fixtures shall be so installed with regard to spacing as to be accessible for their intended use and for cleansing;
- (14) Plumbing shall be installed with due regard to preservation of the strength of structural members and prevention of damage to walls and other surfaces through fixture usage; and
- (15) Suitable provisions shall be made for disposing of the sewage by some accepted method of sewage treatment and disposal.

---

36-25-16. Local regulations permitted -- Minimum standards -- Plumbing by registrant pending municipal permit. Nothing in this chapter shall prohibit any municipality by ordinance from making and enforcing requirements and standards regarding plumbing, and from making inspections and collecting fees relating thereto. Any such ordinances shall be deemed the applicable standards as to any plumbing work in such municipality, provided that the standards as contained in such ordinances meet the minimum standards of the State Plumbing Code as adopted by the commission, and that any person registered by the commission may do plumbing work in such municipality for a period of six months following application for a permit or license in said municipality.

---

36-25-17. License required for plumbing work on public waterworks or sewerage system -- Exceptions. No person may engage in plumbing for which a permit is required pursuant to § 36-25-19 on any property which is in connection with a public system of waterworks or sewerage unless that person is licensed by the commission. No license is required of a person who does the following work in compliance with the provisions of the minimum standards prescribed by the commission:

- (1) Plumbing on premises or that part of the premises owned and actually occupied by the person as the person's residence;
- (2) Plumbing repair work on premises where the person is employed and performing the plumbing repair work; or
- (3) Plumbing repair work on the person's own property.

---

36-25-17.1. Licensure without examination for certain qualified plumbers -- Time limit -- Licensure with examination thereafter. Any person who provides satisfactory evidence to the commission before July 1, 2004, that the person was continually engaged for six months prior to July 1, 2003, in the business for which a license is required pursuant to § 36-25-17 in a rural area or a municipality of less than fifteen hundred population as shown by the last federal decennial census shall be licensed without examination upon payment of the fee established by the commission in a rule promulgated pursuant to chapter 1-26. After June 30, 2004, the commission may waive certain licensing requirements for an applicant in a rural area or a municipality of less than fifteen hundred population as shown by the last federal decennial census, if the applicant passes an examination given by the commission that demonstrates that the applicant knows the laws and rules governing plumbing. Any person registered under the provisions of this section shall be restricted to performing plumbing in a rural area or a municipality of less than fifteen hundred population. The commission may, by rules promulgated pursuant to chapter 1-26, provide for a license for applicants in a rural area or a municipality of less than fifteen hundred population.

---

36-25-17.2. Training to be provided -- Scope and contents -- Exception. The commission shall provide or arrange for training programs on the plumbing code and applicable laws and rules governing plumbing for persons licensed under § 36-25-17.1, except for those persons showing competency by passing a state administered plumbing examination. Each person licensed as a plumbing contractor or journeyman plumber shall receive a minimum of four hours training of potable water distribution systems and four hours training of drainage, waste, and vent systems during the first year of licensure.

---

36-25-18. Commission as committee of examiners -- Duties of committee. The commission shall also serve as a committee of plumbing examiners. The duties of such committee shall be to examine the qualifications of all persons having made application to the commission for a permit to engage in the business or trade of plumbing contractor, plumber, or plumber's apprentice.

---

36-25-19. Application for plumber's permit -- Examination of applicants -- Reexamination fees. Application for a plumber's permit shall be made to the commission, accompanied by the proper fee.

Unless the applicant is entitled to a renewal he shall be registered by the commission only after satisfactorily passing an examination showing fitness to practice his trade. Examinations may be held in conjunction with any quarterly meeting of the commission.

The commission may promulgate rules to establish reexamination fees for: plumbing contractor, plumber, water conditioning and treatment plumbing contractor, water conditioning and treatment plumbing installer, appliance plumbing contractor, appliance plumbing installer, sewer and water plumbing contractor, sewer and water plumbing apprentice installer, manufactured and mobile home contractor, manufactured and mobile home installer, manufactured and mobile home apprentice, underground irrigation contractor, underground irrigation installer and underground irrigation installer apprentice.

---

36-25-19.1. Plumbing installation certificate -- Plumbing inspection -- Fees. The commission shall collect a plumbing permit fee from any person responsible for the installation of plumbing work. The plumbing inspection fee shall include the fee for a plumbing installation certificate, plus the appropriate fees for the plumbing fixtures to be inspected. The maximum fee for permits in a single-family dwelling unit is fifty dollars. The maximum fee for permits in a multiple-dwelling unit or public building is two hundred dollars. The commission shall establish by rule adopted pursuant to chapter 1-26 the fee for the plumbing installation certificate and the fees for inspections of plumbing fixtures.

---

36-25-19.2. Plumbing permit not required in certain situations. No plumbing permit is required if the plumbing repair work or plumbing fixture replacement:

- (1) Does not involve cutting into or extending existing water and waste systems;
- (2) Is done on buildings that are not connected to a public system of waterworks or sewerage;

or

- (3) Is conducted by full-time maintenance personnel on the business premises of an employer.

No plumbing permit is required in any political subdivision where a local plumbing permit has been issued, unless a state-conducted inspection is requested in addition to the local inspection. Any person requesting such inspection is responsible for paying any plumbing permit fee for the requested inspection.

---

36-25-19.3. Fees for plumbing code training courses. Any person participating in any code training courses offered by the commission shall remit a fee not to exceed twenty-five dollars. The commission shall establish the training fee, by rules promulgated pursuant to chapter 1-26, to offset expenses of the training.

---

36-25-20. Omitted.

---

36-25-21. Reciprocity with other states. The commission may register, without examination upon

the payment of the required fee, nonresident applicants registered under the laws of other states having requirements for regulating plumbers which the commission determines are substantially equivalent to the requirements of this state.

---

36-25-22. Registration and issuance of permit -- Expiration and renewal -- Renewal of license fees. The commission shall register and issue a permit to applicants who have successfully qualified for such permit under the provisions of this chapter and upon payment of the fee herein provided. Permits shall expire December thirty-first of each year, but may be renewed upon application made not later than the following January thirty-first.

The commission shall promulgate rules to establish the renewal of license fees for: plumbing contractor, plumber, water conditioning plumbing installer apprentice, water conditioning and treatment plumbing contractor, water conditioning plumbing installer, appliance installation plumbing contractor, appliance plumbing installer, appliance plumbing installer apprentice, sewer and water installation plumbing contractor, sewer and water plumbing installer, sewer and water plumbing installer apprentice, manufactured and mobile home contractor, manufactured and mobile home installer, manufactured and mobile home apprentice, underground irrigation contractor, underground irrigation installer and underground irrigation installer apprentice.

---

36-25-22.1. Registration without examination. Any person who, before June 30, 1994, furnishes satisfactory evidence to the commission that he was engaged in business as an underground irrigation contractor or an underground irrigation installer between January 1, 1993, and July 1, 1993, in this state shall be registered without examination, upon payment of fees as established by the commission by rules adopted pursuant to chapter 1-26.

---

36-25-23. Temporary permits. The commission may issue temporary, revocable permits for a period of not to exceed one year, to persons furnishing satisfactory evidence to the board of their qualifications.

---

36-25-24. Fees for permits, initial examination and license, and temporary license. Fees for permits for plumbing contractors and plumbers shall be promulgated in rules by the commission, which fees shall be payable prior to taking the examination for the first time.

There shall be no fee for a plumber's apprentice provided such person shall be actively engaged in the trade of an apprentice plumber as defined in this chapter, but no person is entitled to such permit for longer than four years.

The fee for a temporary permit shall be as determined by the commission. The commission shall promulgate rules, pursuant to chapter 1-26, to establish initial examination and license fees and temporary license fees for: plumbing contractor, plumber, water conditioning and treatment plumbing contractor, water conditioning plumbing installer, appliance installation plumbing contractor, appliance plumbing installer, sewer and water plumbing contractor, sewer and water plumbing installer, manufactured and mobile home contractor, manufactured and mobile home installer, manufactured and mobile home apprentice, underground irrigation contractor, underground irrigation installer and underground irrigation installer apprentice.

---

36-25-24.1. "Underground irrigation" defined. As used in §§ 36-25-14, 36-25-19, 36-25-22, 36-25-22.1, and 36-25-24, the term, underground irrigation, refers to any nonagricultural, landscape irrigation system.

---

36-25-25. Disposition of fees. Repealed by SL 1971, ch 216, § 2.

---

36-25-26. Notice to commission of change of address. Every holder of any permit granted under the provisions of this chapter shall promptly notify the commission of any change in his business or residence address.

---

36-25-27. Revocation of permit -- Grounds. The commission may revoke the permit of any person for a willful violation of any of the rules and regulations of the commission, for violation of the State Plumbing Code, local ordinances applicable to plumbing work, or for knowingly aiding or abetting any unlicensed person to do plumbing work where permits are required under this chapter.

---

36-25-28. Procedure for revocation of permit. Before revoking any permit the commission shall comply with chapter 1-26.

---

36-25-29. Omitted.

---

36-25-30. Violation of chapter as misdemeanor. Any person, firm, or corporation violating any provision of this chapter is guilty of a Class 2 misdemeanor.

---

36-25-31. Injunction to prevent violations -- Election of remedies. The State Plumbing Commission shall be empowered to commence actions for injunction for violation of this chapter or regulations hereunder as an alternate to criminal proceedings. The commencement of one proceeding by the commission constitutes an election.

---

**ARTICLE 20:53**

**PLUMBERS**

Chapter	
20:53:01	Definitions.
20:53:02	Administration.
20:53:03	Plumbers licenses.
20:53:04	Water conditioning licenses.
20:53:05	Appliance installation licenses.
20:53:06	Sewer and water installer licenses.
20:53:07	Manufactured and mobile home licenses.
20:53:08	Underground irrigation licenses.
20:53:09	Restricted licenses.
20:53:10	Plumbing permits.

**CHAPTER 20:53:01**

**DEFINITIONS**

Section	
20:53:01:01	Definitions.

**20:53:01:01. Definitions.** The terms defined in SDCL 36-25-1 have the same meaning when used in this article. For the purpose of this article, the following terms mean:

(1) "Appliance installation," the making of local connections to water and waste systems of all miscellaneous and commercial equipment designed to use electricity or gas or both as a basic source of energy; maintenance and service of this equipment, including operation, adjustment, repair, removal, and renovation; but not connection and repair of household and commercial plumbing fixtures that are designed for sanitary use or water conditioning;

(2) "Appliance installation contractor," a person who engages in the business or trade of appliance installation;

(3) "Appliance installer," a person other than an appliance installation contractor who, as his principal occupation, is engaged as an employee of or otherwise working under the direction of an appliance installation contractor in appliance installation;

(4) "Appliance installer apprentice," a person other than an appliance installer contractor or appliance installer who is working as an employee of an appliance installer contractor and is under the immediate and personal supervision of either an appliance installer contractor or an appliance installer for the purpose of learning and assisting in appliance installation;



(5) "Restricted license," a license that permits a person to hold a plumbing contractor, plumber, plumber apprentice, water conditioning contractor, water conditioning installer, water conditioning apprentice, appliance contractor, appliance installer, appliance apprentice, sewer and water contractor, sewer and water installer, sewer and water apprentice, mobile home contractor, mobile home installer, mobile home apprentice, underground irrigation contractor, underground irrigation installer, or underground irrigation apprentice license in a rural area or a municipality of less than fifteen hundred population;

(6) "Sewer and water installation," the setting up of building sewer and water service, the repair of existing building sewer and water service, the setting up of building storm sewer, the repair of existing building storm sewer, and the setting up of water treatment plant piping and equipment designed to purify water, chemical treatment piping, and sewer treatment plant piping and equipment designed to treat sewage, and the repair of the piping and equipment. For the purposes of this definition, the water service terminates at the water service building valve and the sewer service terminates three feet inside the building wall;

(7) "Sewer and water installation contractor," a person who engages in the trade or business of selling and setting up sewer and water installations;

(8) "Sewer and water installer," a person other than a sewer contractor who, as his principal occupation, is engaged as an employee of or is otherwise working under the direction of a sewer and water contractor in sewer and water installation;

(9) "Sewer and water installer apprentice," a person other than a sewer and water installer contractor or a sewer and water installer who is engaged in working as an employee of a sewer and water contractor and is under the direct immediate supervision of either a sewer and water contractor or a sewer and water installer for the purpose of learning and assisting in the setting up of sewer and water installations.

**Source:** SL 1975, ch 16, § 1; 12 SDR 151, 12 SDR 155, effective July 1, 1986; 19 SDR 36, effective September 17, 1992; 30 SDR 25, effective August 31, 2003.

**General Authority:** SDCL 36-25-14, 36-25-17.1.

**Law Implemented:** SDCL 36-25-17.1, 36-25-18.

## CHAPTER 20:53:02

### ADMINISTRATION

#### Section

20:53:02:01	Repealed.
20:53:02:02	Duties of president.
20:53:02:03	Duties of vice-president.
20:53:02:04	Duties of secretary-treasurer.
20:53:02:05	Office of the commission.
20:53:02:06 and 20:53:02:07	Repealed.
20:53:02:08	Testing.
20:53:02:09	Notice of exam.

20:53:02:10	Grading exams.
20:53:02:11	Superseded.
20:53:02:12	Repealed.
20:53:02:13	Petition for declaratory ruling.
20:53:02:14	Commission action on petition.
20:53:02:15	Commission meetings on petition for new rules.
20:53:02:16	Repealed.
20:53:02:17	Finality of commission decision.
20:53:02:18	Failure to appear for examination.
20:53:02:19	Temporary permits.
20:53:02:20	License expiration.
20:53:02:21	Reciprocity.
20:53:02:22	Inspection.
20:53:02:22.01	Concealment and final inspection.
20:53:02:23	Qualifications for plumbing inspector.

**20:53:02:01. Meetings.** Repealed.

**Source:** SL 1975, ch 16, § 1; 7 SDR 56, effective December 16, 1980; 12 SDR 151, 12 SDR 155, effective July 1, 1986; repealed, 30 SDR 25, effective August 31, 2003.

**20:53:02:02. Duties of president.** The president is the principal executive officer of the commission and, subject to the control of the commission, shall in general supervise and control all business and affairs of the commission. He shall preside at all meetings of the commission. All instruments executed by the commission shall be signed by the president or the vice-president in the absence of the president. The commission may specifically designate other duties to the president.

**Source:** SL 1975, ch 16, § 1; 7 SDR 56, effective December 16, 1980; 12 SDR 151, 12 SDR 155, effective July 1, 1986; 12 SDR 151, 12 SDR 155, effective July 1, 1986.

**General Authority:** SDCL 36-25-14.

**Law Implemented:** SDCL 36-25-8.

**20:53:02:03. Duties of vice-president.** The vice-president shall act for the president in the event of his death or inability or refusal to act. When acting for the president, the vice-president shall have all powers of the president. The vice-president may be assigned additional duties by the president or the commission.

**Source:** SL 1975, ch 16, § 1; 7 SDR 56, effective December 16, 1980; 12 SDR 151, 12 SDR 155, effective July 1, 1986.

**General Authority:** SDCL 36-25-14.

**Law Implemented:** SDCL 36-25-8.

**20:53:02:04. Duties of secretary-treasurer.** The secretary-treasurer shall have the following duties: keep the minutes of the commission meetings; assist the president in the performance of his duties including giving all notices that are duly required by law; be custodian of the records and seal of the commission and affix the seal to all documents executed in behalf of the

commission; sign all documents and execute all instruments as directed by the commission; have care and custody and be responsible for all funds and securities deposited with the commission and deposit such funds with the state treasurer who shall credit the moneys to the South Dakota plumbing commission account; and keep records of all applications and licenses issued in the register.

**Source:** SL 1975, ch 16, § 1; 5 SDR 87, effective April 12, 1979; 7 SDR 56, effective December 16, 1980; 12 SDR 151, 12 SDR 155, effective July 1, 1986.

**General Authority:** SDCL 36-25-14.

**Law Implemented:** SDCL 36-25-8.

**Cross-References:** Minutes required to be filed with auditor general, SDCL 1-25-3; Moneys may not be deposited in local banks without permission of state auditor and state treasurer SDCL 4-4-3.

**20:53:02:05. Office of the commission.** The principal office of the commission is in the city of Pierre, Hughes County, South Dakota.

**Source:** SL 1975, ch 16, § 1; 7 SDR 56, effective December 16, 1980; 12 SDR 151, 12 SDR 155, effective July 1, 1986.

**General Authority:** SDCL 36-25-14.

**Law Implemented:** SDCL 36-25-14.

**20:53:02:06. Adoption of rules.** Repealed.

**Source:** SL 1975, ch 16, § 1; repealed, 4 SDR 10, effective August 28, 1977.

**20:53:02:07. Bond of secretary-treasurer.** Repealed.

**Source:** SL 1975, ch 16, § 1; repealed, 5 SDR 87, effective April 12, 1979.

**20:53:02:08. Testing.** All tests shall be prepared and scheduled by the secretary-treasurer.

**Source:** SL 1975, ch 16, § 1; 12 SDR 151, 12 SDR 155, effective July 1, 1986.

**General Authority:** SDCL 36-25-14.

**Law Implemented:** SDCL 36-25-18, 36-25-19.

**20:53:02:09. Notice of exam.** Each applicant shall be given 10 days' notice by first class mail of the time and place of examination. The notice shall only be given the first time an examination is taken. If an applicant fails to appear at his first examination or desires to retake the examination after failing it, he shall obtain the testing date and place from the secretary-treasurer of the commission. An applicant may waive the 10-day notice of the examination.

**Source:** SL 1975, ch 16, § 1; 7 SDR 56, effective December 16, 1980; 12 SDR 151, 12 SDR 155, effective July 1, 1986.

**General Authority:** SDCL 36-25-14.

**Law Implemented:** SDCL 36-25-18, 36-25-19.

**20:53:02:10. Grading exams.** The commission shall grade all examinations, but may delegate responsibilities in grading to the secretary-treasurer.

**Source:** SL 1975, ch 16, § 1; 7 SDR 56, effective December 16, 1980; 12 SDR 151, 12 SDR 155, effective July 1, 1986.

**General Authority:** SDCL 36-25-14.

**Law Implemented:** SDCL 36-25-18, 36-25-19.

**20:53:02:11. Rule changes.** Superseded.

**Code Commission Note:** SDCL 1-26-13 provides a statutory procedure to use for petitioning an agency for amendments to its rules, thus effectively superseding this section.

**20:53:02:12. Agency action on request.** Repealed.

**Source:** SL 1975, ch 16, § 1; repealed, 4 SDR 10, effective August 28, 1977.

**20:53:02:13. Petition for declaratory ruling.** Any person wishing the commission to issue a ruling as to the applicability to that person of any statutory provision or rule or order of the commission may file with the commission a petition in substantially the following form:

**STATE OF SOUTH DAKOTA**  
**State Plumbing Commission**  
**Pierre, South Dakota 57501**

Petition for Declaratory Ruling

Pursuant to the provisions of SDCL 1-26-15, I, (**name of petitioner**), of (**address of petitioner**), am (**title or capacity of petitioner**) and do hereby petition the South Dakota State Plumbing Commission for its declaratory ruling in regard to the following:

1. The state statute or State Plumbing Commission rule or order in question is: (here identify and quote the pertinent statute, rule or order).
2. The facts and circumstances which give rise to the issue to be answered by the commission's declaratory ruling are:
3. The precise issue to be answered by the commission's declaratory ruling is:

Dated at (**city and state**), this \_\_\_\_\_ day of \_\_\_\_\_ 19\_\_.

**(Signature of petitioner)**

**Source:** SL 1975, ch 16, § 1; 7 SDR 56, effective December 16, 1980; 12 SDR 151, 12 SDR 155, effective July 1, 1986.

**General Authority:** SDCL 36-25-14.

**Law Implemented:** SDCL 1-26-15, 36-25-28.

**20:53:02:14. Commission action on petition.** Upon receipt of the petition, the commission may request from the petitioner further information that may be required by it for the issuance of its ruling. Within 30 days following the receipt of the petition or within 30 days following receipt of the further information, the commission shall issue its declaratory ruling and serve a copy of it by certified mail upon the petitioner.

**Source:** SL 1975, ch 16, § 1; 7 SDR 56, effective December 16, 1980; 12 SDR 151, 12 SDR 155, effective July 1, 1986.

**General Authority:** SDCL 36-25-14.

**Law Implemented:** SDCL 1-26-15.

**20:53:02:15. Commission meetings on petition for new rules.** The commission may hold a meeting by telephone conference call to decide on any petitions filed pursuant to SDCL 1-26-13.

**Source:** SL 1975, ch 16, § 1; 4 SDR 10, effective August 28, 1977; 7 SDR 56, effective December 16, 1980; 12 SDR 151, 12 SDR 155, effective July 1, 1986.

**General Authority:** SDCL 36-25-14.

**Law Implemented:** SDCL 1-26-13.

**20:53:02:16. Request for decision from agency.** Repealed.

**Source:** SL 1975, ch 16, § 1; repealed, 4 SDR 10, effective August 28, 1977.

**20:53:02:17. Finality of commission decision.** No decision of the commission shall be effective upon any person until notice of the decision has been given in accordance with SDCL 1-26.

**Source:** SL 1975, ch 16, § 1; 7 SDR 56, effective December 16, 1980; 12 SDR 151, 12 SDR 155, effective July 1, 1986.

**General Authority:** SDCL 36-25-14.

**Law Implemented:** SDCL 1-26, 21-33.

**Cross-Reference:** Appeals from administrative agencies, SDCL 1-26-30 to 1-26-37.

**20:53:02:18. Failure to appear for examination.** All applications for examination for all licenses shall expire and be cancelled after a period of six months from the date of approval for examination. Fees will be forfeited if the applicant fails to appear for examination within that period.

**Source:** SL 1975, ch 16, § 1; 12 SDR 151, 12 SDR 155, effective July 1, 1986.

**General Authority:** SDCL 36-25-14.

**Law Implemented:** SDCL 36-25-18, 36-25-19.

**20:53:02:19. Temporary permits.** Temporary permits for any license issued under these rules may be issued in emergency cases and will expire three months after issuance, unless the applicant is licensed sooner, after examination. The fee for a temporary permit is \$50.

**Source:** SL 1975, ch 16, § 1; 7 SDR 56, effective December 16, 1980; 12 SDR 151, 12 SDR 155, effective July 1, 1986; 26 SDR 33, effective September 12, 1999.

**General Authority:** SDCL 36-25-14, 36-25-24.

**Law Implemented:** SDCL 36-25-23.

**20:53:02:20. License expiration.** All licenses issued under these rules expire December 31 of each year. They may be renewed upon application not later than January 31. After January 31, the commission may renew a license without testing if the applicant shows a reasonable excuse for failure to apply for the license renewal. After January 31 of the following year, the applicant may renew a license only by testing.

**Source:** SL 1975, ch 16, § 1; 7 SDR 56, effective December 16, 1980; 12 SDR 151, 12 SDR 155, effective July 1, 1986; 16 SDR 88, effective November 12, 1989.

**General Authority:** SDCL 36-25-14.

**Law Implemented:** SDCL 36-25-22.

**20:53:02:21. Reciprocity.** Applicants for any license issued by the commission who desire to be licensed without examination shall apply for their South Dakota license on forms provided by the commission. The applicant shall have been licensed by examination in the state from which he comes, the state shall have licensure laws similar to South Dakota's, and the applicant's work in the state from which he comes shall comply with that state's plumbing code and that state's plumbing code shall be equal to or exceed the South Dakota state plumbing code. The commission will investigate these matters and may require affidavits. The commission shall, in writing, grant the license or notify the applicant of the reasons the license is refused. If the license is refused the matter shall be treated as a contested case and a hearing date set. The normal examination fee shall accompany the application.

**Source:** SL 1975, ch 16, § 1; 7 SDR 56, effective December 16, 1980; 12 SDR 151, 12 SDR 155, effective July 1, 1986.

**General Authority:** SDCL 36-25-14.

**Law Implemented:** SDCL 36-25-21.

**Cross-References:**

Examination fees, § 20:53:03:01.

License procedures, fees, and expiration, § 20:53:04:04.

Examination fees, § 20:53:05:02.

Examination fees, § 20:53:06:02.

**20:53:02:22. Inspection.** Inspectors employed by the commission shall carry out inspections of plumbing throughout the state. An inspection request shall be made at least 48 hours in advance, excluding Saturdays, Sundays, and holidays. Testing is the responsibility of the contractor, installer, or plumber and does not need to be witnessed by an inspector. All violations of the state plumbing code shall be cited. The citation shall be personally delivered or mailed to the contractor, installer, plumber, or other person responsible for the violations. The contractor, installer, plumber, or other person responsible for the violations must either correct the cited violations or request a hearing on the matter before the commission within 21 days. Within 10 days after hearing, the commission shall issue its order on the citation which shall set out the action

necessary on the part of the contractor, installer, plumber, or other person responsible for the violations.

**Source:** SL 1975, ch 16, § 1; 7 SDR 56, effective December 16, 1980; 12 SDR 151, 12 SDR 155, effective July 1, 1986; 14 SDR 29, effective September 3, 1987; 30 SDR 40, effective October 1, 2003.

**General Authority:** SDCL 36-25-14.

**Law Implemented:** SDCL 36-25-10, 36-25-17.

**20:53:02:22.01. Concealment and final inspection.** No contractor, installer, plumber, or other person may conceal any drainage, waste, or vent system until a request for an inspection has been made. Backfilling is not considered concealment. If an inspector suspects a code violation, the contractor or the installer shall uncover the work suspected of being in violation of code. An inspector may require a final inspection upon completion of the entire system.

**Source:** 30 SDR 40, effective October 1, 2003.

**General Authority:** SDCL 36-25-14.

**Law Implemented:** SDCL 36-25-10, 36-25-17.

**20:53:02:23. Qualifications for plumbing inspector.** An applicant desiring to apply for a plumbing inspector position with the commission must be a licensed journeyman plumber, a licensed plumbing contractor, or a plumbing inspector certified by the International Association of Plumbing and Mechanical Officials.

**Source:** 15 SDR 136, effective March 15, 1989; 30 SDR 25, effective August 31, 2003.

**General Authority:** SDCL 36-25-14.

**Law Implemented:** SDCL 36-25-10.

## CHAPTER 20:53:03

### PLUMBERS LICENSES

#### Section

20:53:03:01	Examination fees.
20:53:03:02	Experience required for testing.
20:53:03:03	Out-of-state applicants.
20:53:03:04	Trade school credit.
20:53:03:05	Plumber's apprentice license.
20:53:03:06	License renewal fees.
20:53:03:07	Examination requirements.
20:53:03:08	Repealed.
20:53:03:09	Fees for restricted plumbing contractors and plumbers.
20:53:03:10	Examination for restricted plumbing contractors and plumbers.

**20:53:03:01. Examination fees.** An applicant for a plumbing contractor's license must pay an examination and license fee of \$260, and an applicant for a plumber's license must pay an

examination and license fee of \$130 before taking the examination for the first time. The reexamination fee is \$50 for a plumbing contractor's license and \$50 for a plumber's license. No additional fee is charged for the first year of license. No applicant may be examined for the same license more often than every three months.

**Source:** SL 1975, ch 16, § 1; 1 SDR 48, effective December 26, 1974; 4 SDR 10, effective August 28, 1977; 7 SDR 56, effective December 16, 1980; 12 SDR 151, 12 SDR 155, effective July 1, 1986; 14 SDR 29, effective September 3, 1987; 16 SDR 88, effective November 12, 1989; 26 SDR 33, effective September 12, 1999; 29 SDR 52, effective October 20, 2002

**General Authority:** SDCL 36-25-14, 36-25-19, 36-25-24.

**Law Implemented:** SDCL 1-26-6.9, 36-25-18, 36-25-19, 36-25-24.

**20:53:03:02. Experience required for testing.** An applicant for a plumbing contractor's license shall show evidence of six years' experience as a plumbing contractor, plumber, or plumber's apprentice with at least two of those years as a plumbing contractor or plumber. During the six years the applicant must have spent at least 1900 hours per year as a plumbing contractor, plumber, or plumber's apprentice. Applicants for a plumber's license shall show evidence of four years' experience as an apprentice plumber. During the four years the applicant must have spent at least 1900 hours per year as an apprentice. Credit for military plumbing is given at the rate of one year credit for each two years in the military up to a maximum of five years of credit. The commission shall provide forms for such applications and may investigate the individual's experience. If the commission finds the individual has the required experience, the individual shall be tested. If the commission does not allow testing based on the application, it shall notify the applicant that the applicant is being refused a license and the matter shall be treated as a contested case.

**Source:** SL 1975, ch 16, § 1; 6 SDR 71, effective January 27, 1980; 7 SDR 56, effective December 16, 1980; 12 SDR 151, 12 SDR 155, effective July 1, 1986; 21 SDR 40, effective September 4, 1994; 26 SDR 33, effective September 12, 1999.

**General Authority:** SDCL 36-25-14.

**Law Implemented:** SDCL 36-25-18, 36-25-19.

**20:53:03:03. Out-of-state applicants.** Applicants for a plumber's license or contractor's license from out-of-state may take the examination upon showing by affidavits the same qualifications in the state from which the applicant comes that are required of applicants from South Dakota. The secretary-treasurer shall investigate the truth of such affidavits. Application blanks may be obtained from the commission. A rejected application shall be treated as a contested case.

**Source:** SL 1975, ch 16, § 1; 7 SDR 56, effective December 16, 1980; 12 SDR 151, 12 SDR 155, effective July 1, 1986.

**General Authority:** SDCL 36-25-14.

**Law Implemented:** SDCL 36-25-18.

**20:53:03:04. Trade school credit.** Graduates of an accredited trade school having at least a 9-month program in plumbing with at least 1,020 hours of plumbing instruction or graduates of a 3-year accredited association apprenticeship training program may apply for a plumber's examination after 3 years in which they have had 5,700 hours experience as a plumber's apprentice.



**Source:** SL 1975, ch 16, § 1; 7 SDR 56, effective December 16, 1980; 12 SDR 151, 12 SDR 155, effective July 1, 1986.

**General Authority:** SDCL 36-25-14.

**Law Implemented:** SDCL 36-25-18.

- \* 9/23/04 **20:53:03:05. Plumber's apprentice license.** An applicant for a plumber's apprentice license must fill out an application, which may be obtained from the commission, showing the plumber under which the applicant is working. The license is without charge but must be renewed annually. Apprentice plumbers who have completed two years (3800 hours) of experience in learning about and assisting in the installation, alteration, and repair of plumbing under a plumbing contractor may work without immediate and personal supervision on single family dwellings if the apprentice plumber is under the employment of a plumbing contractor and can demonstrate competency by passing an examination administered by the commission. The examination fee is \$50.

**Source:** SL 1975, ch 16, § 1; 1 SDR 48, effective December 26, 1974; 4 SDR 10, effective August 28, 1977; 7 SDR 56, effective December 16, 1980; 8 SDR 176, effective July 4, 1982; 12 SDR 151, 12 SDR 155, effective July 1, 1986; 14 SDR 29, effective September 3, 1987; 16 SDR 88, effective November 12, 1989; 26 SDR 33, effective September 12, 1999; 29 SDR 52, effective October 20, 2002; 31 SDR 35, effective September 23, 2004.

**General Authority:** SDCL 36-25-14.

**Law Implemented:** SDCL 1-26-6.9, 36-25-18, 36-25-24.

**20:53:03:06. License renewal fees.** The license renewal fee for a plumbing contractor after the first year of licensure is \$210 per year. The license renewal fee for a plumber after the first year of licensure is \$80 per year.

**Source:** SL 1975, ch 16, § 1; 4 SDR 10, effective August 28, 1977; 7 SDR 56, effective December 16, 1980; 12 SDR 151, 12 SDR 155, effective July 1, 1986; 14 SDR 29, effective September 3, 1987; 16 SDR 88, effective November 12, 1989; 26 SDR 33, effective September 12, 1999; 29 SDR 52, effective October 20, 2002.

**General Authority:** SDCL 36-25-14, 36-25-22.

**Law Implemented:** SDCL 1-26-6.9, 36-25-22, 36-25-24.

**20:53:03:07. Examination requirements.** Examination for applicants desiring to become licensed shall consist of the following:

- (1) Questions which are based on the code. The applicant may not use the code to answer these questions;
- (2) Questions which are based on the code. The applicant may use the code to answer these questions;
- (3) Drawings of plumbing fixtures on which the applicant is to draw all stacks, wastes, and vents and to insert the pipe size. The code may not be used on this portion.

The questions and drawings for plumbing contractors and plumbers need not be the same. The passing grade for plumbing contractors is 80 percent and the passing grade for plumbers is 70

percent. If a plumber receives 80 percent or above on his plumber examination, the plumber is not required to write the plumbing contractor examination when he applies for the plumbing contractor's license, but must pay the license and examination fee in § 20:53:03:01 for a plumbing contractor's license and must meet experience requirements for plumbing contractors in § 20:53:03:02.

**Source:** SL 1975, ch 16, § 1; 12 SDR 151, 12 SDR 155, effective July 1, 1986; 16 SDR 88, effective November 12, 1989.

**General Authority:** SDCL 36-25-14.

**Law Implemented:** SDCL 36-25-18, 36-25-19.

**20:53:03:08. Identification of work installed.** Repealed.

**Source:** SL 1975, ch 16, § 1; 7 SDR 56, effective December 16, 1980; 12 SDR 151, 12 SDR 155, effective July 1, 1986; repealed, 30 SDR 25, effective August 31, 2003.

**20:53:03:09. Fees for restricted plumbing contractors and plumbers.** The fee for a restricted plumbing contractor licensed under the provisions of SDCL 36-25-17.1 is \$80. If the fee is submitted to the commission before December 31, 2003, the license is valid through December 31, 2004. The license renewal fee is \$80 per year. The fee for a restricted plumber licensed under the provisions of SDCL 36-25-17.1 is \$40. If the fee is submitted to the commission before December 31, 2003, the license is valid through December 31, 2004. The license renewal fee is \$40 per year.

**Source:** 30 SDR 25, effective August 31, 2003.

**General Authority:** SDCL 36-25-17.1, 36-25-19, 36-25-22.

**Law Implemented:** SDCL 1-26-6.9, 36-25-17.1, 36-25-17.2.

**20:53:03:10. Examination for restricted plumbing contractors and plumbers.** The examination for an applicant desiring to become licensed after June 30, 2004, shall be based on the plumbing code. The applicant may use the code to answer the questions. The passing grade for this exam is 70 percent.

**Source:** 30 SDR 25, effective August 31, 2003.

**General Authority:** SDCL 36-25-17.1, 36-25-17.2.

**Law Implemented:** SDCL 36-25-17.1, 36-25-17.2.

## CHAPTER 20:53:04

### WATER CONDITIONING LICENSES

#### Section

- 20:53:04:01 Definitions.
- 20:53:04:02 Licenses.
- 20:53:04:03 Examination.

20:53:04:04	License fees -- Renewal.
20:53:04:05	Temporary licenses.
20:53:04:06	Reexamination fees and periods.
20:53:04:07	Out-of-state contractors and installers.
20:53:04:08	Enforcement and penalty.
20:53:04:09	Fees for restricted water conditioning contractors and installers.
20:53:04:10	Examination for restricted water conditioning contractors and installers.

**20:53:04:01. Definitions.** For the purpose of articles 20:53 and 20:54, these terms have the following meaning:

(1) "Water conditioning, treatment, installation, and repair," the treatment of water and the installation of appliances, appurtenances, fixtures, and plumbing necessary thereto, all designed to treat water to alter, modify, add, or remove mineral, chemical, or bacterial content and to repair such equipment to a water distribution system. Water conditioning installation, repair, and treatment do not mean the exchange of appliances, appurtenances, and fixtures when the plumbing has previously been installed or adapted for such appliances, appurtenances, and fixtures, and no substantial change in the plumbing system is required;

(2) "Water conditioning and treatment plumbing contractor," a person who engages in the trade or business of water treatment and the installation of water conditioning equipment and apparatus and of maintaining and servicing it, including operation, adjustment, repair, removal, and renovation;

(3) "Water conditioning plumbing installer," a person other than a water conditioning and treatment contractor who, as his principal occupation, is engaged as an employee of or otherwise working under the direction of a water conditioning and treatment plumbing contractor in the treatment of water and the installation of water conditioning and treatment equipment and who is lawfully qualified and registered as a water conditioning plumbing installer pursuant to the provisions of these articles;

(4) "Water conditioning plumbing installer apprentice," a person other than a water conditioning and treatment plumbing contractor or water conditioning plumbing installer who is engaged in working as an employee of a water conditioning and treatment plumbing contractor under the immediate and personal supervision of either a water conditioning and treatment plumbing contractor or a water conditioning plumbing installer in learning and assisting in the plumbing installation of water conditioning, treatment, installation, and repair.

**Source:** SL 1975, ch 16, § 1; 4 SDR 10, effective August 28, 1977; 12 SDR 151, 12 SDR 155, effective July 1, 1986.

**General Authority:** SDCL 36-25-14, 36-25-15.

**Law Implemented:** SDCL 36-25-15.

**20:53:04:02. Licenses.** Licenses shall be issued by the commission under the rules set out in this chapter, to persons engaged in the trade or business of water conditioning, treatment, installation, and repair who are qualified under this chapter; however, such licenses are not

required of persons licensed as plumbing contractors, plumbers, or plumber's apprentices under SDCL 36-25-1.

**Source:** SL 1975, ch 16, § 1; 7 SDR 56, effective December 16, 1980; 12 SDR 151, 12 SDR 155, effective July 1, 1986.

**General Authority:** SDCL 36-25-14, 36-25-15.

**Law Implemented:** SDCL 36-25-15.

**20:53:04:03. Examination.** The examination for applicants desiring to become licensed shall consist of questions that are based on the code. The applicant may use the code to answer the questions.

The questions for water conditioning and treatment plumbing contractor and installer need not be the same. The passing grade for a water conditioning and treatment plumbing contractor is 80 percent and the passing grade for an installer is 70 percent. If a water conditioning plumbing installer receives 80 percent or above on the installer examination, the installer is not required to write the water conditioning plumbing contractor examination when applying for the contractor's license, but must pay the license and examination fee in § 20:53:04:04 for a contractor's license.

**Source:** SL 1975, ch 16, § 1; 4 SDR 10, effective August 28, 1977; 12 SDR 151, 12 SDR 155, effective July 1, 1986; 16 SDR 88, effective November 12, 1989; 26 SDR 33, effective September 12, 1999.

**General Authority:** SDCL 36-25-14, 36-25-15.

**Law Implemented:** SDCL 36-25-15.

**20:53:04:04. License fees -- Renewal.** Water conditioning licenses and fees are as follows:

- (1) For a water conditioning and treatment plumbing contractor's license, \$175, which is payable before taking the examination for the first time. Thereafter, the fee is \$125 a year;
- (2) For a water conditioning plumbing installer's license, \$100, which is payable before taking the examination for the first time. Thereafter, the fee is \$50 a year; and
- (3) For a water conditioning plumbing installer apprentice license, applicants must fill out an application showing the water conditioning plumbing contractor under whom the applicant is working. The license is without charge for two years and must be renewed annually. After two years the fee is \$50.

**Source:** SL 1975, ch 16, § 1; 1 SDR 48, effective December 26, 1974; 4 SDR 10, effective August 28, 1977; 7 SDR 56, effective December 16, 1980; 12 SDR 151, 12 SDR 155, effective July 1, 1986; 14 SDR 29, effective September 3, 1987; 16 SDR 88, effective November 12, 1989; 26 SDR 33, effective September 12, 1999; 29 SDR 52, effective October 20, 2002.

**General Authority:** SDCL 36-25-14, 36-25-22, 36-25-24.

**Law Implemented:** SDCL 1-26-6.9, 36-25-15, 36-25-19, 36-25-22, 36-25-24.

**20:53:04:05. Temporary licenses.** A temporary license for an additional fee of \$50 may be issued for emergency cases only and expire three months from the date of issuance or when the license holder passes the examination required by § 20:53:04:03, whichever occurs first.

**Source:** SL 1975, ch 16, § 1; 7 SDR 56, effective December 16, 1980; 12 SDR 151, 12 SDR 155, effective July 1, 1986; 26 SDR 33, effective September 12, 1999.

**General Authority:** SDCL 36-25-24.

**Law Implemented:** SDCL 36-25-15, 36-25-24.

**20:53:04:06. Reexamination fees and periods.** An applicant for an examination is entitled to one examination only for each examination fee paid. All applications expire six months after the date of approval and the fees are forfeited if the applicant fails to appear for an examination within that period. If an applicant fails to pass an examination, he may not take another examination until at least three months have passed from the date of his last examination. Reexamination fees are \$50 for water conditioning and treatment plumbing contractors and \$50 for a water conditioning plumbing installer.

**Source:** SL 1975, ch 16, § 1; 4 SDR 10, effective August 28, 1977; 12 SDR 151, 12 SDR 155, effective July 1, 1986; 16 SDR 88, effective November 12, 1989.

**General Authority:** SDCL 36-25-14, 36-25-15.

**Law Implemented:** SDCL 1-26-6.9, 36-25-15, 36-25-19, 36-25-24.

**20:53:04:07. Out-of-state contractors and installers.** Applicants who are water conditioning and treatment plumbing contractors in other states who desire to work in this state in localities where a state water conditioning and treatment plumbing contractor's license is required may apply for a water conditioning and treatment plumbing contractor's examination and license. Proof of the water conditioning and treatment plumbing contractor's license from another state shall be vouched for as provided on the application blank furnished by the commission. Applicants who are water conditioning and treatment plumbing installers in other states or who desire to work in this state in localities where a state installer's license is required may apply for an installer's examination and license. Proof of the installer's license from another state shall be vouched for as provided on the application blank furnished by the commission.

**Source:** SL 1975, ch 16, § 1; 4 SDR 10, effective August 28, 1977; 7 SDR 56, effective December 16, 1980; 12 SDR 151, 12 SDR 155, effective July 1, 1986.

**General Authority:** SDCL 36-25-14, 36-25-15.

**Law Implemented:** SDCL 36-25-15.

**20:53:04:08. Enforcement and penalty.** It is unlawful for a water conditioning and treatment plumbing contractor, water conditioning plumbing installer, or apprentice to operate contrary to the foregoing water conditioning and treatment rules in this chapter. Enforcement and penalty provisions are identical to those found in SDCL 36-25.

**Source:** SL 1975, ch 16, § 1; 4 SDR 10, effective August 28, 1977; 12 SDR 151, 12 SDR 155, effective July 1, 1986.

**General Authority:** SDCL 36-25-14, 36-25-15.

**Law Implemented:** SDCL 36-25-15.

**Cross Reference:** Violation of SDCL 36-25 as Class 2 misdemeanor, SDCL 36-25-30.

**20:53:04:09. Fees for restricted water conditioning contractors and installers.** The fee for a restricted water conditioning contractor licensed under the provisions of SDCL 36-25-17.1 is \$80. If the fee is submitted to the commission before December 31, 2003, the license is valid through December 31, 2004. The license renewal fee is \$80 per year. The fee for a restricted water conditioning installer licensed under the provisions of SDCL 36-25-17.1 is \$40. If the fee is submitted to the commission before December 31, 2003, the license is valid through December 31, 2004. The license renewal fee is \$40 per year.

**Source:** 30 SDR 25, effective August 31, 2003.

**General Authority:** SDCL 36-25-17.1, 36-25-19, 36-25-22.

**Law Implemented:** SDCL 1-26-6.9, 36-25-17.1, 36-25-17.2.

**20:53:04:10. Examination for restricted water conditioning contractors and installers.** The examination for an applicant desiring to become licensed after June 30, 2004, shall be based on the plumbing code. The applicant may use the code to answer the questions. The passing grade for this exam is 70 percent.

**Source:** 30 SDR 25, effective August 31, 2003.

**General Authority:** SDCL 36-25-17.1.

**Law Implemented:** SDCL 36-25-17.1, 36-25-17.2.

## **CHAPTER 20:53:05**

### **APPLIANCE INSTALLATION LICENSES**

#### Section

- 20:53:05:01 Appliance plumbing installers' licenses.
- 20:53:05:02 Examination fees.
- 20:53:05:03 Experience required for testing.
- 20:53:05:04 Out-of-state applicants.
- 20:53:05:05 Appliance plumbing installer apprentice license.
- 20:53:05:06 License renewal fees.
- 20:53:05:07 Examination requirements.
- 20:53:05:08 Fees for restricted appliance contractors and installers.
- 20:53:05:09 Examination for restricted appliance contractors and installers.

**20:53:05:01. Appliance plumbing installers' licenses.** Special licenses shall be issued by the commission to persons engaged in plumbing necessary for installing and repairing plumbing appliances. This license allows the licensee to carry on only such plumbing as is necessary for appliance installation.

**Source:** SL 1975, ch 16, § 1; 4 SDR 10, effective August 28, 1977; 7 SDR 56, effective December 16, 1980; 12 SDR 151, 12 SDR 155, effective July 1, 1986.

**General Authority:** SDCL 36-25-14.

**Law Implemented:** SDCL 36-25-14.

**20:53:05:02. Examination fees.** An applicant for an appliance installation plumbing contractor's license must pay an examination and license fee of \$175, and an applicant for an appliance plumbing installer's license must pay an examination and license fee of \$100 before taking the examination for the first time. The reexamination fee is \$50 for an appliance plumbing contractor's license and \$50 for an appliance plumbing installer's license. No additional fee is charged for the first year of licensure. No applicant may be examined for the same license more often than once in three months.

**Source:** SL 1975, ch 16, § 1; 1 SDR 48, effective December 26, 1974; 4 SDR 10, effective August 28, 1977; 7 SDR 56, effective December 16, 1980; 12 SDR 151, 12 SDR 155, effective July 1, 1986; 14 SDR 29, effective September 3, 1987; 16 SDR 88, effective November 12, 1989; 26 SDR 33, effective September 12, 1999; 29 SDR 52, effective October 20, 2002.

**General Authority:** SDCL 36-25-19, 36-25-24.

**Law Implemented:** SDCL 1-26-6.9, 36-25-14, 36-25-19, 36-25-24.

**20:53:05:03. Experience required for testing.** An applicant for an appliance plumbing installer's license shall show evidence of two years' experience as an appliance plumbing installer apprentice in South Dakota. An applicant for an appliance plumbing installation contractor's license shall have one year's experience as an appliance plumbing installer in South Dakota. Proof of experience shall be shown by affidavits which the commission may investigate. The commission shall provide forms to the applicant. The applicant shall show that the applicant's work complies with the state plumbing code, article 20:54. If the commission rejects the application, the matter shall be treated as a contested case.

**Source:** SL 1975, ch 16, § 1; 4 SDR 10, effective August 28, 1977; 7 SDR 56, effective December 16, 1980; 12 SDR 151, 12 SDR 155, effective July 1, 1986; 26 SDR 33, effective September 12, 1999.

**General Authority:** SDCL 36-25-14.

**Law Implemented:** SDCL 36-25-14, 36-25-18.

**20:53:05:04. Out-of-state applicants.** Applicants for an appliance installation plumbing contractor or installer's license from out-of-state may take the examination upon showing by affidavits that he has the same qualifications in the state from which he comes that are required of applicants from South Dakota. The commission shall provide forms for the applicant. The secretary-treasurer shall investigate the truth of the affidavits. If the application is rejected, the matter shall be treated as a contested case.

**Source:** SL 1975, ch 16, § 1; 4 SDR 10, effective August 28, 1977; 7 SDR 56, effective December 16, 1980; 12 SDR 151, 12 SDR 155, effective July 1, 1986.

**General Authority:** SDCL 36-25-14.

**Law Implemented:** SDCL 36-25-14.

**20:53:05:05. Appliance plumbing installer apprentice license.** An applicant for an appliance plumbing installer apprentice license shall fill out an application showing the appliance plumbing contractor under which the applicant is working. The license is without charge for two years and shall be renewed annually.

**Source:** SL 1975, ch 16, § 1; 4 SDR 10, effective August 28, 1977; 7 SDR 56, effective December 16, 1980; 12 SDR 151, 12 SDR 155, effective July 1, 1986; 26 SDR 33, effective September 12, 1999.

**General Authority:** SDCL 36-25-24.

**Law Implemented:** SDCL 36-25-24.

**20:53:05:06. License renewal fees.** The license renewal fee for an appliance installation plumbing contractor after the first year of licensure is \$125 a year. The license renewal fee for an appliance plumbing installer after the first year of licensure is \$50 a year. The license renewal fee for the appliance plumbing installer apprentice after the first two years of licensure is \$50.

**Source:** SL 1975, ch 16, § 1; 1 SDR 48, effective December 26, 1974; 4 SDR 10, effective August 28, 1977; 7 SDR 56, effective December 16, 1980; 12 SDR 151, 12 SDR 155, effective July 1, 1986; 14 SDR 29, effective September 3, 1987; 16 SDR 88, effective November 12, 1989; 26 SDR 33, effective September 12, 1999; 29 SDR 52, effective October 20, 2002.

**General Authority:** SDCL 36-25-22.

**Law Implemented:** SDCL 1-26-6.9, 36-25-19, 36-25-22.

**20:53:05:07. Examination requirements.** Examination for applicants desiring to become licensed shall consist of the following:

(1) Questions which are based upon appliance installation and application. The applicant may use the code to answer these questions.

The questions for the appliance plumbing contractor and the appliance plumbing installer need not be the same. The passing grade for the appliance installation plumbing contractor is 80 percent and the passing grade for the appliance plumbing installer is 70 percent. If an appliance plumbing installer receives 80 percent or above on his installer examination, the installer is not required to write the appliance plumbing contractor's examination when he applies for the contractor's license, but must pay the license and examination fee for a contractor's license and must meet the experience requirements for appliance plumbing contractors in § 20:53:05:03.

**Source:** SL 1975, ch 16, § 1; 4 SDR 10, effective August 28, 1977; 12 SDR 151, 12 SDR 155, effective July 1, 1986; 16 SDR 88, effective November 12, 1989.

**General Authority:** SDCL 36-25-14.

**Law Implemented:** SDCL 36-25-14.

**20:53:05:08. Fees for restricted appliance contractors and installers.** The fee for a restricted appliance contractor licensed under the provisions of SDCL 36-25-17.1 is \$80. If the fee is submitted to the commission before December 31, 2003, the license is valid through December 31, 2004. The license renewal fee is \$80 per year. The fee for a restricted appliance installer licensed under the provisions of SDCL 36-25-17.1 is \$40. If the fee is submitted to the commission before December 31, 2003, the license is valid through December 31, 2004. The license renewal fee is \$40 per year.

**Source:** 30 SDR 25, effective August 31, 2003.

**General Authority:** SDCL 36-25-17.1, 36-25-19, 36-25-22.

**Law Implemented:** SDCL 1-26-6.9, 36-25-17.1, 36-25-17.2.



**20:53:05:09. Examination for restricted appliance contractors and installers.** The examination for an applicant desiring to become licensed after June 30, 2004, shall be based on the plumbing code. The applicant may use the code to answer the questions. The passing grade for this exam is 70 percent.

**Source:** 30 SDR 25, effective August 31, 2003.

**General Authority:** SDCL 36-25-17.1.

**Law Implemented:** SDCL 36-25-17.1, 36-25-17.2.

## CHAPTER 20:53:06

### SEWER AND WATER INSTALLER LICENSES

#### Section

20:53:06:01	Sewer and water plumbing installer licenses.
20:53:06:02	Examination fees.
20:53:06:03	Experience for testing.
20:53:06:04	Out-of-state applicants.
20:53:06:05	Sewer and water plumbing installer apprentice license.
20:53:06:06	License renewal fees.
20:53:06:07	Examination requirements.
20:53:06:08	Fees for restricted sewer and water contractors and installers.
20:53:06:09	Examination for restricted sewer and water contractors and installers.

**20:53:06:01. Sewer and water plumbing installer licenses.** Special licenses shall be issued by the commission to persons engaged in plumbing necessary for installing and repairing sewer and water plumbing installations. This license allows the licensee to only carry on such plumbing as may be necessary for sewer and water installation.

**Source:** SL 1975, ch 16, § 1; 4 SDR 10, effective August 28, 1977; 7 SDR 56, effective December 16, 1980; 12 SDR 151, 12 SDR 155, effective July 1, 1986.

**General Authority:** SDCL 36-25-14.

**Law Implemented:** SDCL 36-25-14.

**20:53:06:02. Examination fees.** An applicant for a sewer and water plumbing contractor's license must pay an examination and license fee of \$225, and an applicant for a sewer and water plumbing installer's license must pay an examination and license fee of \$100 before taking the examination for the first time. The reexamination fee is \$50 for a sewer and water plumbing contractor's license and \$50 for a sewer and water plumbing installer's license. No additional fee is charged for the first year of licensure. No applicant may be examined for the same license more often than once in three months.

**Source:** SL 1975, ch 16, § 1; 1 SDR 48, effective December 26, 1974; 4 SDR 10, effective August 28, 1977; 7 SDR 56, effective December 16, 1980; 12 SDR 151, 12 SDR 155, effective

July 1, 1986; 14 SDR 29, effective September 3, 1987; 16 SDR 88, effective November 12, 1989; 26 SDR 33, effective September 12, 1999; 29 SDR 52, effective October 20, 2002.

**General Authority:** SDCL 36-25-19, 36-25-24.

**Law Implemented:** SDCL 1-26-6.9, 36-25-15, 36-25-19, 36-25-24.

**20:53:06:03. Experience for testing.** An applicant for a sewer and water plumbing installer's license shall show evidence of two years experience as a sewer and water plumbing installer apprentice in South Dakota. An applicant for a sewer and water plumbing installation contractor's license shall have one year's experience as an installer in South Dakota. All applicants shall show that their work complies with the state plumbing code, article 20.54. Proof of experience shall be shown by affidavits which the commission may investigate. The commission shall provide applicants with forms. If the application is rejected, the matter shall be treated as a contested case.

**Source:** SL 1975, ch 16, § 1; 4 SDR 10, effective August 28, 1977; 7 SDR 56, effective December 16, 1980; 12 SDR 151, 12 SDR 155, effective July 1, 1986; 26 SDR 33, effective September 12, 1999.

**General Authority:** SDCL 36-25-14.

**Law Implemented:** SDCL 36-25-14.

**20:53:06:04. Out-of-state applicants.** Applicants for a sewer and water plumbing installer or contractor's license from out-of-state may take the examination upon showing by affidavits that he has the experience in the state from which he comes that is required of applicants from South Dakota. The commission shall provide forms. The secretary-treasurer shall investigate the truth of the affidavits. A rejected application shall be treated as a contested case.

**Source:** SL 1975, ch 16, § 1; 4 SDR 10, effective August 28, 1977; 7 SDR 56, effective December 16, 1980; 12 SDR 151, 12 SDR 155, effective July 1, 1986.

**General Authority:** SDCL 36-25-14.

**Law Implemented:** SDCL 36-25-14.

**20:53:06:05. Sewer and water plumbing installer apprentice license.** An applicant for a sewer and water plumbing installer apprentice license shall fill out an application showing the sewer and water plumbing contractor under which the applicant is working. The license is without charge for two years and shall be renewed annually.

**Source:** SL 1975, ch 16, § 1; 4 SDR 10, effective August 28, 1977; 7 SDR 56, effective December 16, 1980; 12 SDR 151, 12 SDR 155, effective July 1, 1986; 26 SDR 33, effective September 12, 1999.

**General Authority:** SDCL 36-25-14.

**Law Implemented:** SDCL 36-25-14, 36-25-24.

**20:53:06:06. License renewal fees.** The license renewal fee for a sewer and water installation plumbing contractor after the first year of licensure is \$175 a year, and the license renewal fee for a sewer and water plumbing installer after the first year of licensure is \$50 a year. The license renewal fee for a sewer and water plumbing installer apprentice after the first two years is \$50.

**Source:** SL 1975, ch 16, § 1; 1 SDR 48, effective December 26, 1974; 4 SDR 10, effective August 28, 1977; 7 SDR 56, effective December 16, 1980; 12 SDR 151, 12 SDR 155, effective July 1, 1986; 14 SDR 29, effective September 3, 1987; 16 SDR 88, effective November 12, 1989; 26 SDR 33, effective September 12, 1999; 29 SDR 52, effective October 20, 2002.

**General Authority:** SDCL 36-25-22.

**Law Implemented:** SDCL 1-26-6.9, 36-25-14, 36-25-22.

**20:53:06:07. Examination requirements.** The examination for an applicant desiring to become licensed shall consist of questions that are based on the code. The applicant may use the code to answer these questions.

The questions for the sewer and water plumbing contractor and the sewer and water plumbing installer need not be the same. The passing grade for the sewer and water plumbing contractor is 80 percent and the passing grade for the sewer and water plumbing installer is 70 percent. If a sewer and water plumbing installer receives 80 percent or above on the installer examination, the installer is not required to write the contractor examination when applying for the contractor's license, but is required to pay the license and examination fee for a contractor's license and must meet experience requirements for contractors in § 20:53:06:03.

**Source:** SL 1975, ch 16, § 1; 4 SDR 10, effective August 28, 1977; 12 SDR 151, 12 SDR 155, effective July 1, 1986; 16 SDR 88, effective November 12, 1989; 26 SDR 33, effective September 12, 1999.

**General Authority:** SDCL 36-25-14.

**Law Implemented:** SDCL 36-25-14.

**20:53:06:08. Fees for restricted sewer and water contractors and installers.** The fee for a restricted sewer and water contractor licensed under the provisions of SDCL 36-25-17.1 is \$80. If the fee is submitted to the commission before December 31, 2003, the license is valid through December 31, 2004. The license renewal fee is \$80 per year. The fee for a restricted sewer and water installer licensed under the provisions of SDCL 36-25-17.1 is \$40. If the fee is submitted to the commission before December 31, 2003, the license is valid through December 31, 2004. The license renewal fee is \$40 per year.

**Source:** 30 SDR 25, effective August 31, 2003.

**General Authority:** SDCL 36-25-17.1, 36-25-19, 36-25-22.

**Law Implemented:** SDCL 1-26-6.9, 36-25-17.1, 36-25-17.2.

**20:53:06:09. Examination for restricted sewer and water contractors and installers.** The examination for an applicant desiring to become licensed after June 30, 2004, shall be based on the plumbing code. The applicant may use the code to answer the questions. The passing grade for this exam is 70 percent.

**Source:** 30 SDR 25, effective August 31, 2003.

**General Authority:** SDCL 36-25-17.1.

**Law Implemented:** SDCL 36-25-17.1, 36-25-17.2.

## CHAPTER 20:53:07

## MANUFACTURED AND MOBILE HOME LICENSES

### Section

20:53:07:01	Definitions.
20:53:07:02	Manufactured and mobile home licenses.
20:53:07:03	Examination fees.
20:53:07:04	Experience required for testing.
20:53:07:05	Out-of-state applicants.
20:53:07:06	Manufactured and mobile home apprentice license.
20:53:07:07	License renewal fees.
20:53:07:08	Examination requirements.
20:53:07:09	Fees for restricted manufactured and mobile home contractors and installers.
20:53:07:10	Examination for restricted manufactured and mobile home contractors and installers.

**20:53:07:01. Definitions.** For the purpose of this chapter, these terms have the following meaning:

(1) "Manufactured home," a structure which is transportable in one or more sections, which is 8 feet or more wide or 40 feet or more long in the traveling mode or is 320 or more square feet when erected on a site; which is built on a permanent chassis and designed to be used as a dwelling, with or without a permanent foundation, when connected to the required utilities; and which contains in it the plumbing, heating, air conditioning and electrical systems;

(2) "Mobile home," a movable or portable unit, designed and constructed to be towed on its own chassis comprised of frame and wheels and designed to be connected to utilities for year-round occupancy. The term includes the following:

(a) Units containing parts that may be folded, collapsed, or telescoped when being towed and that may be expanded to provide additional cubic capacity; and

(b) Units composed of two or more separately towable components designed to be joined into one integral unit capable of being separated again into the components for repeated towing;

(3) "Manufactured and mobile home plumbing installation," connection to local water and waste systems from manufactured and mobile homes only, including maintenance and service which include the operation, adjustment, repair, removal, and renovation of such connections;

(4) "Manufactured and mobile home plumbing installation contractor," a person who engages in the business or trade of manufactured and mobile home water and waste connections;

(5) "Manufactured and mobile home plumbing installer," a person other than a manufactured and mobile home plumbing installation contractor who, as his principal occupation, is engaged as an employee of or otherwise working under the direction of a manufactured and mobile home plumbing installation contractor, in manufactured and mobile home water and waste connections;

(6) "Manufactured and mobile home apprentice," a person other than a manufactured and mobile home plumbing installation contractor or manufactured and mobile home plumbing installer who is working as an employee of a manufactured and mobile home plumbing installation contractor under the immediate and personal supervision of either a manufactured and mobile home plumbing installation contractor or a manufactured and mobile home plumbing installer in learning and assisting in manufactured and mobile home water and waste connections.

**Source:** 14 SDR 29, effective September 3, 1987.

**General Authority:** SDCL 36-25-14, 36-25-15.

**Law Implemented:** SDCL 36-25-15.

**20:53:07:02. Manufactured and mobile home licenses.** Special licenses shall be issued by the commission to persons engaged in plumbing necessary for water and waste connections for manufactured and mobile homes. This license allows the licensee to carry on only such plumbing as necessary for manufactured and mobile home connections. Such licenses are not required of persons licensed as plumbing contractors, plumbers, or plumber apprentices under SDCL 36-25-1.

**Source:** 14 SDR 29, effective September 3, 1987.

**General Authority:** SDCL 36-25-14.

**Law Implemented:** SDCL 36-25-14.

**20:53:07:03. Examination fees.** An applicant for a manufactured and mobile home plumbing installation contractor's license must pay an examination and license fee of \$175, and an applicant for a manufactured and mobile home plumbing installer's license must pay an examination and license fee of \$100 before taking the examination the first time. The reexamination fee is \$50 for a manufactured and mobile home plumbing installation contractor's license and \$50 for a manufactured and mobile home plumbing installer's license. No additional fee is charged for the first year of licensure. No applicant may be examined for the same license more often than once in three months.

**Source:** 14 SDR 29, effective September 3, 1987; 16 SDR 88, effective November 12, 1989; 26 SDR 33, effective September 12, 1999; 29 SDR 52, effective October 20, 2002.

**General Authority:** SDCL 36-25-19, 36-25-24.

**Law Implemented:** SDCL 1-26-6.9, 36-25-15, 36-25-19, 36-25-24.

**20:53:07:04. Experience required for testing.** An applicant for a manufactured or mobile home plumbing installer must show evidence of two years experience as a manufactured and mobile home plumbing installer apprentice. Applicants for a manufactured and mobile home plumbing installation contractor must have one year of experience as a manufactured and mobile home plumbing installer. Proof of experience shall be shown by affidavits which the commission may investigate. The applicant must show that the applicant's work complies with applicable codes. If the commission rejects the application, the matter shall be treated as a contested case.

**Source:** 14 SDR 29, effective September 3, 1987; 26 SDR 33, effective September 12, 1999.

**General Authority:** SDCL 36-25-14.

**Law Implemented:** SDCL 36-25-14.

**Cross-Reference:** Finality of commission decision, § 20:53:02:17.

**20:53:07:05. Out-of-state applicants.** Applicants for a manufactured and mobile home plumbing installation contractor's license or a manufactured and mobile home plumbing installer's license from out of state may take the examination upon showing by affidavits that he has the same qualifications in the state from which he comes as are required of applicants from South Dakota. The commission shall provide forms for the applicant. The executive secretary shall investigate the truth of the affidavits. If the application is rejected, the matter shall be treated as a contested case.

**Source:** 14 SDR 29, effective September 3, 1987.

**General Authority:** SDCL 36-25-14.

**Law Implemented:** SDCL 36-25-14.

**Cross-Reference:** Finality of commission decision, § 20:53:02:17.

**20:53:07:06. Manufactured and mobile home apprentice license.** All applicants for a manufactured and mobile home apprentice license must fill out an application showing the manufactured and mobile home plumbing installation contractor under which the applicant is working. The license is without charge for two years and must be renewed annually.

**Source:** 14 SDR 29, effective September 3, 1987.

**General Authority:** SDCL 36-25-14.

**Law Implemented:** SDCL 36-25-14.

**20:53:07:07. License renewal fees.** The license renewal fee for a manufactured and mobile home plumbing installation contractor after the first year of licensure is \$125 a year. The license renewal fee for a manufactured and mobile home plumbing installer after the first year of licensure is \$50. The license renewal fee for a manufactured and mobile home plumbing installer apprentice after the first two years of licensure is \$50.

**Source:** 14 SDR 29, effective September 3, 1987; 16 SDR 88, effective November 12, 1989; 26 SDR 33, effective September 12, 1999; 29 SDR 52, effective October 20, 2002.

**General Authority:** SDCL 36-25-22.

**Law Implemented:** SDCL 1-26-6.9, 36-25-14, 36-25-22.

**20:53:07:08. Examination requirements.** The examination for applicants desiring to become licensed shall consist of questions which are based on the code. The applicant may use the code to answer these questions.

The questions for the manufactured and mobile home plumbing installation contractor and the manufactured and mobile home plumbing installer need not be the same. The passing grade for the manufactured and mobile home plumbing installation contractor is 80 percent and the passing grade for the manufactured and mobile home plumbing installer is 70 percent. If a manufactured and mobile home plumbing installer receives 80 percent or above on his installer examination, the installer is not required to write the contractor examination when he applies for the contractor's license, but must pay the license and examination fee for a contractor's license and must meet experience requirements for contractors in § 20:53:07:04.

**Source:** 14 SDR 29, effective September 3, 1987; 16 SDR 88, effective November 12, 1989.

**General Authority:** SDCL 36-25-14.

**Law Implemented:** SDCL 36-25-14.

**Cross-Reference:** State plumbing code, art 20:54.

**20:53:07:09. Fees for restricted manufactured and mobile home contractors and installers.** The fee for a restricted manufactured and mobile home contractor licensed under the provisions of SDCL 36-25-17.1 is \$80. If the fee is submitted to the commission before December 31, 2003, the license is valid through December 31, 2004. The license renewal fee is \$80 per year. The fee for a restricted manufactured and mobile home installer licensed under the provisions of SDCL 36-25-17.1 is \$40. If the fee is submitted to the commission before December 31, 2003, the license is valid through December 31, 2004. The license renewal fee is \$40 per year.

**Source:** 30 SDR 25, effective August 31, 2003.

**General Authority:** SDCL 36-25-17.1, 36-25-19, 36-25-22.

**Law Implemented:** SDCL 1-26-6.9, 36-25-17.1, 36-25-17.2.

**20:53:07:10. Examination for restricted mobile home contractors and installers.** The examination for an applicant desiring to become licensed after June 30, 2004, shall be based on the plumbing code. The applicant may use the code to answer the questions. The passing grade for this exam is 70 percent.

**Source:** 30 SDR 25, effective August 31, 2003.

**General Authority:** SDCL 36-25-17.1.

**Law Implemented:** SDCL 36-25-17.1, 36-25-17.2.

## CHAPTER 20:53:08

### UNDERGROUND IRRIGATION LICENSES

#### Section

20:53:08:01	Definitions.
20:53:08:02	Underground irrigation licenses.
20:53:08:03	Examination fees.
20:53:08:04	Experience required for testing.
20:53:08:05	Out-of-state applicants.
20:53:08:06	Underground irrigation apprentice license.
20:53:08:07	License renewal fees.
20:53:08:08	Examination requirements.
20:53:08:09	Fees for restricted underground irrigation contractors and installers.
20:53:08:10	Examination for restricted underground irrigation contractors and installers.

**20:53:08:01. Definitions.** For the purpose of this chapter, these terms have the following meaning:

(1) "Underground irrigation installation," the practice of and the furnishing or the use of materials and devices for the purpose of installing underground irrigation systems and connecting them to the local source of potable water, including maintenance and service which include the operation, adjustment, repair, removal, and renovation of such connections and devices;

(2) "Underground irrigation contractor," a person who engages in the business or trade of installing underground irrigation system plumbing inside or outside a building and connecting it to the local source of potable water;

(3) "Underground irrigation installer," a person whose principal occupation is to work as an employee of or under the direction of an underground irrigation contractor in installing underground irrigation system plumbing;

(4) "Underground irrigation apprentice," a person who works as an employee of an underground irrigation contractor under the immediate and personal supervision of either an underground irrigation contractor or underground irrigation installer for the purpose of learning and assisting in installing underground irrigation system plumbing.

**Source:** 20 SDR 29, effective September 1, 1993.

**General Authority:** SDCL 36-25-14, 36-25-15.

**Law Implemented:** SDCL 36-25-15.

**20:53:08:02. Underground irrigation licenses.** Persons engaged in underground irrigation installation must have a special underground irrigation license issued by the commission. Such a license is not required of persons licensed as plumbing contractors, plumbers, or plumber apprentices under SDCL 36-25-1.

**Source:** 20 SDR 29, effective September 1, 1993.

**General Authority:** SDCL 36-25-14.

**Law Implemented:** SDCL 36-25-14.

**20:53:08:03. Examination fees.** An applicant for an underground irrigation contractor's license must pay an examination and license fee of \$175, and an applicant for an underground irrigation installer's license must pay an examination and license fee of \$100 before taking the examination the first time. The reexamination fee is \$50 for an underground irrigation contractor's license and \$50 for an underground irrigation installer's license. No additional fee is charged for the first year of licensure. An applicant may not be examined for the same license more often than once in three months.

**Source:** 20 SDR 29, effective September 1, 1993; 26 SDR 33, effective September 12, 1999; 29 SDR 52, effective October 20, 2002.

**General Authority:** SDCL 36-25-19, 36-25-24.

**Law Implemented:** SDCL 1-26-6.9, 36-25-15, 36-25-19, 36-25-24.

**20:53:08:04. Experience required for testing.** An applicant for an underground irrigation installer's license must show evidence of two years of experience as an underground irrigation apprentice. An applicant for an underground irrigation contractor's license must have one year of experience as an underground irrigation installer or a combination of three years of experience as



an underground irrigation apprentice or installer. An applicant must provide proof of experience by means of affidavits. The commission may investigate an applicant's experience. An applicant must show that the applicant's work complies with applicable codes. If the commission rejects the application, the matter shall be treated as a contested case.

**Source:** 20 SDR 29, effective September 1, 1993; 26 SDR 33, effective September 12, 1999.

**General Authority:** SDCL 36-25-14.

**Law Implemented:** SDCL 36-25-14.

**Cross-References:** Finality of commission decision, § 20:53:02:17; Contested case procedure, SDCL ch 1-26.

**20:53:08:05. Out-of-state applicants.** An applicant from out of state for an underground irrigation contractor's license or an underground irrigation installer's license may take the examination upon showing by affidavits that he has the same qualifications as are required of applicants from South Dakota. The commission shall provide forms for the applicant. The executive secretary shall investigate the truth of the affidavits. If the application is rejected, the matter shall be treated as a contested case.

**Source:** 20 SDR 29, effective September 1, 1993.

**General Authority:** SDCL 36-25-14.

**Law Implemented:** SDCL 36-25-14.

**Cross-References:** Finality of commission decision, § 20:53:02:17; Contested case procedure, SDCL ch 1-26.

**20:53:08:06. Underground irrigation apprentice license.** An applicant for an underground irrigation apprentice license must fill out an application showing the underground irrigation contractor under which the applicant is working. The license is without charge for two years and must be renewed annually.

**Source:** 20 SDR 29, effective September 1, 1993.

**General Authority:** SDCL 36-25-14.

**Law Implemented:** SDCL 36-25-14.

**20:53:08:07. License renewal fees.** The license renewal fee for an underground irrigation contractor after the first year of licensure is \$125 a year. The license renewal fee for an underground irrigation installer after the first year of licensure is \$50. The license renewal fee for an underground irrigation apprentice after the first two years of licensure is \$50.

**Source:** 20 SDR 29, effective September 1, 1993; 26 SDR 33, effective September 12, 1999; 29 SDR 52, effective October 20, 2002.

**General Authority:** SDCL 36-25-22.

**Law Implemented:** SDCL 1-26-6.9, 36-25-14, 36-25-22.

**20:53:08:08 Examination requirements.** The examination for applicants desiring to become licensed under this chapter shall consist of questions which are based on the code. The applicant may use the code to answer the questions.

The questions for the underground irrigation contractor and the underground irrigation installer need not be the same. The passing grade for the underground irrigation contractor is 80 percent and the passing grade for the underground irrigation installer is 70 percent. If an underground irrigation installer receives 80 percent or above on his installer examination, the installer is not required to write the contractor examination when he applies for the contractor's license, but must pay the license and examination fee for a contractor's license and must meet experience requirements for contractors in § 20:53:08:04.

**Source:** 20 SDR 29, effective September 1, 1993.

**General Authority:** SDCL 36-25-14.

**Law Implemented:** SDCL 36-25-14.

**Cross-Reference:** State plumbing code, art 20:54.

**20:53:08:09. Fees for restricted underground irrigation contractors and installers.** The fee for a restricted underground irrigation contractor licensed under the provisions of SDCL 36-25-17.1 is \$80. If the fee is submitted to the commission before December 31, 2003, the license is valid through December 31, 2004. The license renewal fee is \$80 per year. The fee for a restricted underground irrigation installer licensed under the provisions of SDCL 36-25-17.1 is \$40. If the fee is submitted to the commission before December 31, 2003, the license is valid through December 31, 2004. The license renewal fee is \$40 per year.

**Source:** 30 SDR 25, effective August 31, 2003.

**General Authority:** SDCL 36-25-17.1, 36-25-19, 36-25-22.

**Law Implemented:** SDCL 1-26-6.9, 36-25-17.1, 36-25-17.2.

**20:53:08:10. Examination for restricted underground irrigation contractors and installers.** The examination for an applicant desiring to become licensed after June 30, 2004, shall be based on the plumbing code. The applicant may use the code to answer the questions. The passing grade for this exam is 70 percent.

**Source:** 30 SDR 25, effective August 31, 2003.

**General Authority:** SDCL 36-25-17.1.

**Law Implemented:** SDCL 36-25-17.1, 36-25-17.2.

## CHAPTER 20:53:09

### RESTRICTED LICENSES

#### Section

- 20:53:09:01 Training.
- 20:53:09:02 Acceptable course offerings.
- 20:53:09:03 Exceptions and extensions.
- 20:53:09:04 Attendance by staff or commission members.
- 20:53:09:05 Criteria for granting training course credit.
- 20:53:09:06 Application for approval of instructor and course offering.

20:53:09:07 Suspension, revocation, or denial of course approval.  
20:53:09:08 Training course certificate of attendance.  
20:53:09:09 Program changes.  
20:53:09:10 Sponsor to provide list of persons attending program.  
20:53:09:11 Course fees.  
20:53:09:12 Notice.  
20:53:09:13 Facilities.

**20:53:09:01. Training.** As used in this chapter, the term training, means educational experience derived from participation in approved lectures, seminars, or courses on plumbing rules and regulations or other related areas in plumbing that have been approved by the commission, to improve the professional skills and upgrade the standards of restricted licensees for the purpose of protecting the health and welfare of the citizens of the state.

**Source:** 30 SDR 25, effective August 31, 2003.

**General Authority:** SDCL 36-25-14, 36-25-17.1.

**Law Implemented:** SDCL 36-25-17.1, 36-25-17.2.

**20:53:09:02. Acceptable course offerings.** The following courses meet the requirements of the training required by SDCL 36-25-17.2:

- (1) Plumbing commission offered courses dealing with the plumbing code;
- (2) South Dakota Association of Plumbing, Heating, Cooling Contractor offered courses dealing with the plumbing code;
- (3) International Association of Plumbing and Mechanical Officials offered courses dealing with the plumbing code; and
- (4) Plumbing commission pre-approved correspondence courses.

**Source:** 30 SDR 25, effective August 31, 2003.

**General Authority:** SDCL 36-25-14, 36-25-17.1.

**Law Implemented:** SDCL 36-25-17.2.

**20:53:09:03. Exceptions and extensions.** The commission may make exceptions and grant extensions for the required training for reasons of health, military service, or other reasonable cause if adequate proof is provided to the commission. A nonresident licensee is exempt from the training requirements if the licensee meets all the plumbing licensing requirements in the state of the licensee's residence. A resident licensee is exempt from the training requirements if the licensee provides adequate proof that the licensee's license is inactive and not being used for the purpose of conducting the business of plumbing or for the purpose of performing plumbing.

**Source:** 30 SDR 25, effective August 31, 2003.

**General Authority:** SDCL 36-25-14, 36-25-17.1.

**Law Implemented:** SDCL 36-25-17.1, 36-25-17.2.

**20:53:09:04. Attendance by staff or commission members.** Any staff or member of the commission may attend and supervise any training program.

**Source:** 30 SDR 25, effective August 31, 2003.

**General Authority:** SDCL 36-25-14, 36-25-17.1.

**Law Implemented:** SDCL 36-25-17.1, 36-25-17.2.

**20:53:09:05. Criteria for granting training course credit.** The commission may grant training credit for courses, seminars, conferences, correspondence courses, or similar offerings that are provided by the commission or any public or private school, organization, association, person, corporation, society, or similar organization if the course meets the following criteria:

(1) The total instruction time is not less than eight hours;

(2) The public or private school, organization, association, person, corporation, society, or similar organization certifies the attendance of each licensee at the offering or the completion of a training course;

(3) Credit is earned on the basis of attendance, or in the case of correspondence courses, completion of the course; and

(4) The instructor of the training course meets at least one of the following qualifications:

(a) Licensed as a South Dakota journeyman plumber or plumbing contractor;

(b) Licensed mechanical engineer; or

(c) State certified vocational instructor with mechanical experience.

**Source:** 30 SDR 25, effective August 31, 2003.

**General Authority:** SDCL 36-25-14, 36-25-17.1.

**Law Implemented:** SDCL 36-25-17.1, 36-25-17.2.

**20:53:09:06. Application for approval of instructor and course offering.** An application for approval of the instructor and course offering must be on a form provided by the plumbing commission. The application form must include the following information and enclosures;

(1) The instructor's name, address, and telephone number;

(2) The title of the course offering;

(3) A complete description or copies of all material to be distributed to the participants;

(4) The date and exact location of each presentation of the course offering;

(5) A duration and time of course offering;

(6) A comprehensive, detailed outline of the subject matter together with the time sequence of each segment, faculty of each segment, and teaching technique used in each segment;

(7) The procedure for measuring attendance; and

(8) A description of the faculty, including name, professional education background, and practical or teaching experience. A complete résumé may be requested by the commission.

**Source:** 30 SDR 25, effective August 31, 2003.

**General Authority:** SDCL 36-25-14, 36-25-17.1.

**Law Implemented:** SDCL 36-25-17.1, 36-25-17.2.

**20:53:09:07. Suspension, revocation, or denial of course approval.** The plumbing commission may deny, suspend, or revoke approval of a plumbing course offering if the commission determines that it is not in compliance with this chapter.

**Source:** 30 SDR 25, effective August 31, 2003.

**General Authority:** SDCL 36-25-14, 36-25-17.1.

**Law Implemented:** SDCL 36-25-17.1, 36-25-17.2.

**20:53:09:08. Training course certificate of attendance.** The instructor of each course shall provide an individual certificate of attendance to each person who attends 90 percent or more of the classroom hours. A certificate of attendance may not be issued to a person who is absent more than 10 percent of the classroom hours. The certificate must contain the person's name, South Dakota restricted plumbing license number, course title, date, location of course, number of credit hours, and signature of the instructor. The person attending the course shall provide a copy of the certificate of attendance to the commission.

**Source:** 30 SDR 25, effective August 31, 2003.

**General Authority:** SDCL 36-25-14, 36-25-17.1.

**Law Implemented:** SDCL 36-25-17.1, 36-25-17.2.

**20:53:09:09. Program changes.** An instructor shall submit any program changes to the commission for approval prior to enactment. The commission shall approve or disapprove program changes within 45 days.

**Source:** 30 SDR 25, effective August 31, 2003.

**General Authority:** SDCL 36-25-14, 36-25-17.1.

**Law Implemented:** SDCL 36-25-17.1, 36-25-17.2.

**20:53:09:10. Sponsor to provide list of persons attending program.** The instructor of a training course shall provide to the commission a written list of the persons attending within 45 days after the completion of the program.

**Source:** 30 SDR 25, effective August 31, 2003.

**General Authority:** SDCL 36-25-14, 36-25-17.1.

**Law Implemented:** SDCL 36-25-17.1, 36-25-17.2.

**20:53:09:11. Course fees.** A participant attending any plumbing commission offered course shall remit \$20 payable prior to the course commencement.

**Source:** 30 SDR 25, effective August 31, 2003.

**General Authority:** SDCL 36-25-19.3.

**Law Implemented:** SDCL 36-25-19.3.

**20:53:09:12. Notice.** At the beginning of each course offering the instructor shall read the following notice to the participants:

"This plumbing course offering is recognized by the South Dakota State Plumbing Commission as ( ) hours of credit toward fulfilling the training course requirements for restricted

plumbing licensees pursuant to South Dakota law. Since it is the concern of the Plumbing Commission that licensees receive a quality education, the comments of each participant will be appreciated. If you have any comments about this plumbing course offering, your comments should be sent to the South Dakota State Plumbing Commission, 118 W. Capitol Avenue, Pierre, South Dakota 57501."

**Source:** 30 SDR 25, effective August 31, 2003.

**General Authority:** SDCL 36-25-14, 36-25-17.1.

**Law Implemented:** SDCL 36-25-17.1, 36-25-17.2.

**20:53:09:13. Facilities.** Each course offering shall have classrooms, facilities, and personnel necessary to implement the offerings adequately.

**Source:** 30 SDR 25, effective August 31, 2003.

**General Authority:** SDCL 36-25-14, 36-25-17.1.

**Law Implemented:** SDCL 36-25-17.1, 36-25-17.2.

## CHAPTER 20:53:10

### PLUMBING PERMITS

#### Section

20:53:10:01	Inspection exemption.
20:53:10:02	Plumbing installation certificate.
20:53:10:03	Schedule of fees.
20:53:10:04	Expiration of permit.

**20:53:10:01. Inspection exemption.** A municipality may apply for permission to enforce a present inspection system or for permission to establish a new inspection system. An application shall be filed with the commission with a copy of the proposed ordinance, bylaw, or other action to be taken by the local municipality. The local municipality shall ensure the following:

(1) Any person performing local plumbing inspections meets the qualifications required of a state plumbing inspector; and

(2) The local plumbing inspector inspects all new plumbing, excluding plumbing repair work, within the jurisdiction of the local municipality to ensure compliance with state and local plumbing codes.

The local municipality shall immediately notify the commission if the local inspection system is temporarily or permanently terminated and turn over the records for all uncompleted inspections to the commission. The commission shall then resume inspections of the area under the rules of the commission.

**Source:** 30 SDR 40, effective October 1, 2003.

**General Authority:** SDCL 36-25-19.1.

**Law Implemented:** SDCL 36-25-19.1, 36-25-19.2.

**20:53:10:02. Plumbing installation certificate.** Any person, including an owner, performing plumbing work, except for plumbing repair work, shall report the work to the commission upon a plumbing installation certificate form. The form shall be obtained from the commission at a cost of \$2 and it becomes the responsibility of the certificate holder. Upon commencement of any plumbing installation which is subject to inspection, the person responsible for the installation shall send the white copy to the office of the commission with the appropriate fee attached. The yellow copy shall be retained by the person responsible for the installation. The pink copy shall be provided to the owner of the premise. The green copy shall be posted at the job location.

**Source:** 30 SDR 40, effective October 1, 2003.

**General Authority:** SDCL 36-25-19.1.

**Law Implemented:** SDCL 36-25-19.1, 36-25-19.2.

**20:53:10:03. Schedule of fees.** The fee for a plumbing installation certificate is \$15 plus a combination of the following applicable fees, subject to the statutory maximums:

(1) Tub/shower	\$2
(2) Lavatory	\$2
(3) Kitchen sink	\$2
(4) Clothes washer	\$2
(5) Laundry tray	\$2
(6) Water closet	\$2
(7) Urinal	\$2
(8) Bar/hand sink	\$2
(9) 3-compartment sink	\$2
(10) Service sink	\$2
(11) Dental unit	\$2
(12) Clinic sink	\$2
(13) Drinking fountain	\$2
(14) Floor drain	\$2
(15) Interceptor	\$2
(16) Separator	\$2
(17) Area drain	\$2
(18) Roof drain	\$2
(19) Sump drain	\$2
(20) Sewage ejector	\$2
(21) Water heater	\$2
(22) Water softener	\$2
(23) Backflow prevention device	\$2
(24) Hose bib	\$2
(25) Future fixture rough-in	\$2

**Source:** 30 SDR 40, effective October 1, 2003.

**General Authority:** SDCL 36-25-19.1.

**Law Implemented:** SDCL 36-25-19.1.

**20:53:10:04. Expiration of permit.** Any permit issued by the commission expires if the work authorized by such permit is not commenced within 180 days from the date of such permit, or if the work authorized by such permit is suspended or abandoned for a period of 180 days. If the permit has expired at any time after the work is commenced, a new permit must first be obtained. The fee for the permit is one-half the amount required for the original permit for such work if no changes have been made in the original plans and specifications for such work and the suspension or abandonment has not exceeded one year. Any person holding an unexpired permit may apply for an extension of the time within which work may commence under that permit if the person is unable to commence work within the time required by this section. The commission may extend the time for action by the person for a period not exceeding 180 days upon written request by the person showing that circumstances beyond the control of the person have prevented action from being taken. No permit may be extended more than once. In order to renew action on a permit after expiration, the person shall pay a new full permit fee.

**Source:** 30 SDR 40, effective October 1, 2003.

**General Authority:** SDCL 36-25-19.1.

**Law Implemented:** SDCL 36-25-19.1.



## Notice

The 2003 edition of the *Uniform Plumbing Code* is developed through a consensus standards development process approved by the American National Standards Institute. This process brings together volunteers representing varied viewpoints and interests to achieve consensus on plumbing issues. While the International Association of Plumbing and Mechanical Officials (IAPMO) administers the process and establishes rules to promote fairness in the development of consensus, it does not independently test, evaluate, or verify the accuracy of any information or the soundness of any judgments contained in its codes and standards.

IAPMO disclaims liability for any personal injury, property, or other damages of any nature whatsoever, whether special, indirect, consequential, or compensatory, directly or indirectly resulting from the publication, use of, or reliance on this document. IAPMO also makes no guaranty or warranty as to the accuracy or completeness of any information published herein.

In issuing and making this document available, IAPMO is not undertaking to render professional or other services for or on behalf of any person or entity. Nor is IAPMO undertaking to perform any duty owed by any person or entity to someone else. Anyone using this document should rely on his or her own independent judgment or, as appropriate, seek the advice of a competent professional in determining the exercise of reasonable care in any given circumstances.

**AN AMERICAN NATIONAL STANDARD**  
**IAPMO/ANSI UPC 1-2003**

# **UNIFORM PLUMBING CODE™**

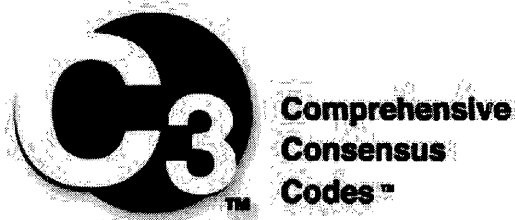
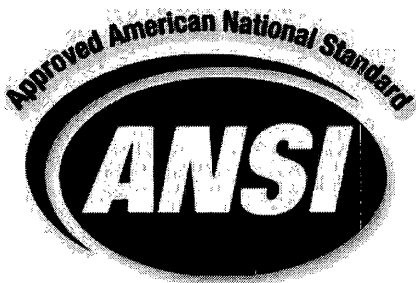

## REVISION MARKINGS

Code changes from the 2000 edition are marked in the margins as follows:

→ An arrow denotes a deletion.

| A vertical denotes a change.

A reference in brackets [ ] following a section or paragraph indicates material that has been extracted from another document. This reprinted material is not the complete and official position of the National Fire Protection Association on the reference subject which is represented by the standard in its entirety.

Information on referenced publications can be found in Chapter 17.

All pressures used in this code are gauge pressures unless otherwise indicated.

Copyright © 2003

by

**International Association of Plumbing and Mechanical Officials**

**All Rights Reserved**

No part of this work may be reproduced or recorded in any form or by any means, except as may be expressly permitted in writing by the publisher.

Twenty-Third Edition

First Printing, January 2003  
Second Printing, October 2003  
Second Printing, December 2003  
Third Printing, March 2004  
Fourth Printing, August 2004  
Fifth Printing, February 2005  
Sixth Printing, August 2005  
Seventh Printing, November 2005  
Eighth Printing, February 2006  
Ninth Printing, November 2006

ISSN 0733-2335

Published by the International Association of Plumbing and Mechanical Officials  
5001 E. Philadelphia Street • Ontario, CA 91761-2816 – USA  
Main Phone: (909) 472-4100 • Main Fax: (909) 472-4150

## 2003 UPC Foreword

The advantages of a uniform plumbing code adopted by various local jurisdictions have long been recognized. Disorder in the industry as a result of widely divergent plumbing practices and the use of many different, often conflicting, plumbing codes by local jurisdictions influenced the Western Plumbing Officials Association (now the International Association of Plumbing and Mechanical Officials [IAPMO]) to form a committee of plumbing inspectors, master and journeyman plumbers, sanitary and mechanical engineers, assisted by public utility companies, and the plumbing industry to create a basic plumbing document for general use. The product of this effort, the first edition of the Uniform Plumbing Code™ (UPC™) was officially adopted by IAPMO in 1945. The widespread use of this code over the past five decades by jurisdictions throughout the United States and internationally is testimony to its merit.

With the publication of the 2003 Edition of the Uniform Plumbing Code, another significant milestone has been reached. For the first time in the history of the United States, a plumbing code developed through a true consensus process has been achieved. Contributions to the content of this code were made by every segment of the built industry including such diverse interests as consumers, enforcing authorities, installers/maintainers, insurance, labor, manufacturers, research/standards/testing laboratories, special experts, and users.

The consensus process, accredited by the American National Standards Institute, serves as the framework for the Comprehensive Consensus™ Code (C3) set – our nation's first true set of ANSI accredited harmonized construction codes for the built industry. IAPMO's C3 partners include the National Fire Protection Association (NFPA), the Western Fire Chiefs Association (WFCA) and the American Society of Heating, Refrigerating and Air Conditioning Engineers (ASHRAE).

The UPC is designed to provide consumers with safe and sanitary plumbing systems while, at the same time, allowing latitude for innovation and new technologies. The public at large is encouraged and invited to participate in IAPMO's open consensus code development process. This code is updated every three years. A code development timeline and other relevant information is available at IAPMO's website at [www.iapmo.org](http://www.iapmo.org).

The Uniform Plumbing Code is dedicated to all those who, in working to achieve "the ultimate plumbing code," have unselfishly devoted their time, effort and personal funds to create and maintain this, the finest plumbing code in existence today.

The 2003 Uniform Plumbing Code is supported by the C3 partners as well as the American Society of Sanitary Engineering (ASSE), Mechanical Contractors Association of America (MCAA), Plumbing-Heating-Cooling Contractors National Association (PHCC-NA), the United Association (UA), and the World Plumbing Council (WPC). The presence of these logos, while reflecting support, does not imply any ownership of the copyright to the UPC which is held exclusively by IAPMO. Further, the logos of these associations indicates the support of IAPMO's open, consensus process being used to develop IAPMO's codes and standards.

The addresses of the organizations are as follows:

ASHRAE – 1791 Tullie Circle, N.E. • Atlanta, GA 30329 • (800) 527-4723

ASSE – 901 Canterbury Road, Suite A • Westlake, OH 44145-7201 • (440) 835-3040

MCAA – 1385 Piccard Drive • Rockville, MD 20850 • (301) 869-5800

NFPA – 1 Batterymarch Park • Quincy, MA 02269 • (617) 770-3000

PHCC-NA – PO Box 6808 • Falls Church, VA 22046 • (800) 533-7694

UA – 901 Massachusetts Avenue NW • Washington, DC 20001 • (202) 628-5823

WFCA – 727 Center Street NE, Suite 300 • Salem, OR 97301 • (503) 588-7665

WPC – WPC Secretary • c/o The Institute of Plumbing • 64 Station Lane • Hornchurch Essex  
RM12 6NB • United Kingdom • +44 17-08-47-27-91

## Tentative Interim Amendment (TIA)

A Tentative Interim Amendment (TIA) to any Document may be processed if the Council Secretary determines, after a preliminary review, and consultation with the appropriate Chair, that the Amendment appears to be of an emergency nature requiring prompt action and has the endorsement of a Member of the involved Technical Committee.

**Section 206.0 Design Flood Elevation** – The elevation of the “design flood,” including wave height, relative to the datum specified on the community’s legally designated flood hazard map.

**Section 206.0 Dialysis Water System** – a collection of water purification devices that will purify and distribute water or the express use of providing a hemodialysis treatment to a patient with End State Renal Disease (ESRD). This collection of water purification devices collectively is considered a medical device and registered with the Food and Drug Administration as a medical device. The water purification devices included in this system could include but are not limited to booster pumps, reverse osmosis (RO) unit, depth filters, carbon filtration tanks, water softener, UV lights, ultrafilters, storage tanks, distribution piping, ozone generators, deionization system, dialyzer reprocessing machines, concentrate mixing systems and artificial kidney machines. *This tentative Interim Amendment (TIA) was issued on December 7, 2005.*

**Section 208.0 Flood Hazard Area** – The greater of the following two areas:

1. The area within a floodplain subject to a 1 percent or greater chance of flooding in any given year.
2. The area designated as a flood hazard area on a community’s flood hazard map, or otherwise legally designated. *This tentative Interim Amendment (TIA) was issued on September 26, 2005.*

**Flood Hazard Area Subject to High Velocity Wave Action** – Area within the flood hazard area which is subject to high velocity wave action, and shown on a Flood Insurance Rate Map or other flood hazard map as Zone V, VO, VE, or V1-30. *This tentative Interim Amendment (TIA) was issued on September 26, 2005.*

**Section 301.3 Flood Hazard Resistance.**

**Section 301.3.1 General.** Plumbing systems shall be located above the design flood elevation.

**Exception:** Plumbing systems are permitted to be located below the design flood elevation provided that the systems are designed and installed to prevent water from entering or accumulating within their components and the systems are constructed to resist hydrostatic and hydrodynamic loads and stresses, including the effects of buoyancy, during the occurrence of flooding to the design flood elevation. *This tentative Interim Amendment (TIA) was issued on September 26, 2005.*

**Section 301.3.2 Flood Hazard Areas Subject to High Velocity Wave Action.** Plumbing systems in buildings located in flood hazard areas subject to high velocity wave action shall meet the requirements of Section 301.3.1 and the plumbing systems, pipes and fixtures shall not be mounted on or penetrate through walls that are intended to breakaway under flood loads as required by the building code. *This tentative Interim Amendment (TIA) was issued on September 26, 2005.*

**Section 412.7** – All shower compartments, regardless of shape, shall have a minimum finished interior of one thousand twenty-four (1024) square inches (0.66 m<sup>2</sup>) and shall also be capable of encompassing a thirty (30) inch (750 mm) circle. The minimum required area and dimensions shall be measured at a height equal to the top of the threshold at a point tangent to its centerline. The minimum area and dimensions shall be maintained to a pint seventy (70) inches (1778 mm) above the shower drain outlet with no protrusions other than fixture valve or valves, shower head, soap dishes, shelves, and safety grab bars or rails. Fold-down seats in accessible shower stalls shall be permitted to protrude into the thirty (30) inch (750 mm) circle.

**Exception No. 1:** Showers which are designed to comply with ICC A117.1.

**Exception No. 2:** The minimum required area and dimension shall not apply where an existing bathtub is replaced by a shower receptor having minimum overall dimensions of 30 inches (750 mm) in width and 60 inches (1,500 mm) in length.

*This tentative Interim Amendment (TIA) was issued on June 15, 2005.*

**Section 507.9 Louvers Grilles and Screens.**

(a) Louvers and Grilles. The required sizes of openings for combustion, ventilation and dilution air shall be based on the net free area of each opening. Where the free area through a design of louver or grille is known, it shall be used in calculating the size opening required to provide the free area specified. Where the design and free area are not known, it shall be assumed that wood louvers will have 25 percent free area and metal louvers and grilles will have 75 percent free area. Non-motorized louvers and grilles shall be fixed in the open position.

(b) Minimum Screen Mesh Size. Screens shall not be smaller than 1/4 inch mesh.

Renumber existing Section 507.9(B) as 507.9 (C).

*This tentative Interim Amendment (TIA) was issued on September 17, 2003*

**Section 603.4.23 Pure Water Process Systems** – The water supply to a pure water process system, such as dialysis systems, chip washing facilities and similar process piping systems, shall be protected from back pressure and back siphonage by a reduced pressure principle backflow preventer. *This tentative Interim Amendment (TIA) was issued on December 7, 2005.*

**Section 603.4.23.1 Dialysis Water System** – The individual connections of the dialysis related equipment to the dialysis pure water system do not require additional backflow protection. *This tentative Interim Amendment (TIA) was issued on December 7, 2005.*

**Section 604.14 Dialysis Water Systems** – Dialysis water purification and distribution systems shall be constructed from materials that do not interact chemically or physically so as to adversely affect the purity of water used for dialysis applications. The materials used shall also be compatible with the type of disinfectant used to disinfect the purified water distribution system. Non-reactive materials shall comply with Section 510(k), CFR 21 shall be used. *This tentative Interim Amendment (TIA) was issued on December 7, 2005.*

**Section 606.1.4 Dialysis Water Systems** – Joints and connections used in dialysis water purification and distribution systems shall be compatible with the material of construction and shall be constructed to minimize dead flow areas. Mechanical, threaded and solvent cemented joints are acceptable. *This tentative Interim Amendment (TIA) was issued on December 7, 2005.*

**Section 715.3** Regarding replacement of existing building sewer and building storm sewers using trenchless methodology and materials shall be installed in accordance with IAPMO IS-26. *This tentative Interim Amendment (TIA) was issued on September 17, 2003.*

**Appendix K, Section K1 Private Sewage Disposal – General**

(A) The Authority Having Jurisdiction may grant exceptions to the provisions of this appendix for permitted structures which have been destroyed due to fire or natural disaster and which cannot be reconstructed in compliance with these provisions provided that such exceptions are the minimum necessary.

(D) Disposal systems shall be located outside of flood hazard areas.

**Exception:** Where suitable sites outside of flood hazard areas are not available, disposal systems may be located in flood hazard areas on sites where the effects of inundation under conditions of the design flood are minimized.

*This tentative Interim Amendment (TIA) was issued on September 26, 2005.*

**Appendix K, Section K5 Septic Tank Construction**

(K) Structure Design

(1) General. Each such tank shall be structurally designed to withstand all....

(2) Flood Loads. In flood hazard areas, tanks shall be anchored to counter buoyant forces during conditions of the design flood. The vent termination and service manhole of the tank shall be a minimum of 2 feet (610 mm) above the design flood elevation or fitted with covers designed to prevent the inflow of floodwater or outflow of the contents of the tanks during conditions of the design flood.

*This tentative Interim Amendment (TIA) was issued on September 26, 2005.*

**Table K-1 Location of Sewage Disposal Systems**

<b>Minimum Horizontal Distance in Clear Required From:</b>	<b>Building Sewer</b>	<b>Septic Tank</b>	<b>Disposal Field</b>	<b>Seepage Pit or Cesspool</b>
Streams and other bodies of water	50 feet (15240 mm)	50 feet (15240 mm)	100 feet (30.5 m)	150 feet (45.7 m)

Note:

7. These minimum clear horizontal distances shall also apply between disposal fields, seepage pits, and the mean high-tide line.

*This tentative Interim Amendment (TIA) was issued on September 26, 2005.*

## COMMITTEE ON UNIFORM PLUMBING CODE

These lists represent the membership at the time the Committee was balloted on the final text of this edition. Since that time, changes in the membership may have occurred.

**Terry Swisher, Chairman**  
State of Oregon, [E]

**James Weflen, Secretary**  
Copper Development Association, [M]

**Julius Ballanco**, JB Engineering/Code Consultant PC [SE]  
Rep. American Society of Plumbing Engineers  
**Paul Cabot**, American Gas Association [U]  
**Sidney Cavanaugh**, United Association [L]  
**Richard Church**, Plastic Pipe and Fittings Association [M]  
**Donald Dickerson**, Donald Dickerson Associates [SE]  
**Kenneth Ford**, National Association of Home Builders [U]  
**Lawrence Gibson**, Intertek Testing Services [R/T]  
**Gary Hile**, Municipality of Anchorage [E]  
**Theodore Lernoff**, NFPA [R/T]  
**William LeVan**, Cast Iron Soil Pipe Institute [M]  
**Perry Meikle**, PW Meikle Consultants [R/T]  
Rep. NSF International  
**David Naughton**, Underwriter Laboratories [R/T]

**Gerald Phariss**, UA Southeast Training Center [R/T]  
Rep. American Society of Sanitary Engineering  
**Robert Rawlings**, State of Idaho [E]  
**Phillips Ribbs**, City of San Jose [E]  
**Arnold Rodio**, Pace Setter Plumbing [I/M]  
**John Roth**, City of Houston [E]  
**Edward Sanchez**, City of Los Angeles [E]  
**Anthony Scarano**, Plastics Piping Consultant [SE]  
**Joseph Sternola**, National Propane Gas Association (NPGA) [U]  
**Don Traylor**, State Plumbing Board of Louisiana [E]  
**David Viola**, Plumbing Manufacturers Institute [M]  
**William Whitehead**, Plumbing and Drainage Institute [M]  
**Richard Zannini**, Plumbing-Heating-Cooling Contractors  
National Association [I/M]

### Alternates

**Rand Ackroyd**, Rand Engineering [M]  
Rep. Plumbing and Drainage Institute  
**Ian Chang**, Intertek Testing Services [R/T]  
**Shannon Corcoran**, American Society of Sanitary Engineering  
[R/T]  
**Bob Friedlander**, Construction Code Consultant [M]  
Rep. Plastic Pipe and Fittings Association  
**Andrew Kireta**, Copper Development Association [M]

**Robert Kordulak**, Plumbing-Heating-Cooling Contractors  
National Association [I/M]  
**Duffy Latham**, City of Los Angeles [E]  
**John Taecker**, Underwriter Laboratories [R/T]  
**April Trafton**, Donald Dickerson Associates [SE]  
**Fred Volkers**, United Association [L]  
**James Walls**, Cast Iron Soil Pipe Institute [M]

### Nonvoting

**Courtney Aford**, Ex-Officio, IAPMO [E]\*  
**John Halliwill**, IAPMO Staff Liaison

**Morrie Klimboff**, Member Emeritus, M Klimboff Consulting [C]\*

### Committee Membership Classification Abbreviations

These classifications apply to Technical Committee members and represent their principal interest in the activity of a committee.

- M** *Manufacturer:* A representative of a maker or marketer of a product, assembly, or system, or portion thereof, that is affected by the standard.
- U** *User:* A representative of an entity that is subject to the provisions of the standard or that voluntarily uses the standard.
- I/M** *Installer/Maintainer:* A representative of an entity that is in the business of installing or maintaining a product, assembly, or system affected by the standard.
- L** *Labor:* A labor representative or employee concerned with safety in the workplace.
- R/T** *Applied Research/Testing Laboratory:* A representative of an independent testing laboratory or independent applied research organization that promulgates and/or enforces standards.
- E** *Enforcing Authority:* A representative of an agency or an organization that promulgates and/or enforces standards.
- I** *Insurance:* A representative of an insurance company, broker, agent, bureau, or inspection agency.
- C** *Consumer:* A person who is, or represents, the ultimate purchaser of a product, system, or service affected by the standard, but who is not included in the *User* classification.
- SE** *Special Expert:* A person not representing any of the previous classifications, but who has special expertise in the scope of the standard or portion thereof.



# FORM FOR PROPOSALS ON IAPMO UPC/UMC COMMITTEE DOCUMENT

**NOTE: All proposals MUST be received by 5:00 PM PST/PDST on the published proposal-closing date.**

For further information on the standards-making process, please contact Codes and Standards Administration at 909-472-4110  
For technical assistance, please call IAPMO at 909-472-4111 or 909-472-4112

**FOR OFFICE USE ONLY**  
LOG # : \_\_\_\_\_  
DATE REC'D: \_\_\_\_\_

## PLEASE USE SEPARATE FORM FOR EACH PROPOSAL

Please indicate in which format you wish to receive your ROP/ROC:  Paper  Download\*  CD-ROM

\*Note: In choosing the download option, you intend to view the ROP/ROC from our website, NO copy will be sent to you.

Date: \_\_\_\_\_ Name: \_\_\_\_\_ Telephone #: \_\_\_\_\_

Company: \_\_\_\_\_

Street Address: \_\_\_\_\_ City: \_\_\_\_\_ State: \_\_\_\_\_ Zip: \_\_\_\_\_

Please Indicate Organization Represented (if any): \_\_\_\_\_

1. a) **IAPMO Document Title** \_\_\_\_\_ **Document Year** \_\_\_\_\_

b) **Section/Paragraph** \_\_\_\_\_

2. **Proposal Recommends** (check one):

3. **Proposal** (Include proposed new or revised wording, or identification of wording to be deleted): [Note: Proposed text should be in legislative format: i.e., use underscore to denote wording to be inserted (inserted wording) and strike-through to denote wording to be deleted (~~deleted wording~~). PLEASE TYPE OR PRINT LEGIBLY IN BLACK INK.]

4. **Statement of Problem and Substantiation for Proposal:** [Note: State the problem that will be resolved by your recommendations; give the specific reason for your proposal, including copies of tests, research papers, etc. If more than 200 words, it may be abstracted for publication.]

5. **This proposal is original material.** [Note: Original material is considered to be the submitter's own idea based on or as a result of his/her own experience, thought, or research and, to the best of his/her knowledge, is not copied from another source.]

**This proposal is not original material, its source (if known) is as follows:** \_\_\_\_\_

I hereby grant IAPMO all and full rights in copyright, in this proposal, and I understand that I acquire no rights in any publication of IAPMO in which this proposal appears in this or another similar or analogous form.

Signature (**Required**): \_\_\_\_\_

IAPMO CODES DEPARTMENT FAX • (909) 472-4157 or (909) 472-4246

Mail to: Secretary, Standards Council • IAPMO • 5001 E Philadelphia Street • Ontario • CA • 91761-2816

## **INSTRUCTIONS FOR SUBMITTING PROPOSALS**

**– PLEASE READ CAREFULLY –**

1. Type or print in BLACK ink.
2. Indicate the title of the document and the document year. Also indicate the specific section or paragraph that the proposed amendment applies to.
3. Check the appropriate box to indicate whether this proposal recommends adding new text, revising existing text, or deleting text.
4. In the space identified as “Proposal”, indicate the exact wording you propose as new or revised text, or the text you propose be deleted.
5. In the space title “Statement of Problem and Substantiation for Proposal”, state the problem which will be resolved by your recommendation and give the specific reason for your proposal. Include copies of test results, research papers, fire experience, or other materials that substantiate your recommendation. [See note below, item (f).]
6. Check the appropriate box to indicate whether or not this proposal is original material, and if it is not, indicate the source of the material.
7. Sign the proposal.

If supplementary material (photographs, diagrams, reports, etc.) is included, you may be required to submit sufficient copies for all members and alternates of the technical committee. The technical committee is authorized to abstract the “Statement of Problem and Substantiation for Proposal” if it exceeds 200 words for publication in the Report on Proposals.

**NOTE:** The IAPMO Regulations Governing Committee Projects in Paragraph 4-3.3 state: Each proposal shall be submitted to the Council Secretary and shall include: (a) identification of the submitter and his or her affiliation (i.e., technical committee, organization, company), where appropriate; (b) identification of the document, edition of the document, and paragraph of the document to which the proposal is directed; (c) the proposed text of the proposal, including the wording to be added, revised (and how revised), or deleted; (d) a statement of the problem and substantiation for proposal; (e) the signature of the submitter; and (f) two copies of any document(s) (other than an IAPMO document) being proposed as a reference standard or publication (see 3-3.7).

## UNIFORM PLUMBING CODE

<p><b>Chapter 1 Administration</b> .....1</p> <p>101.0 Title, Scope, General .....1</p> <p>101.1 Title .....1</p> <p>101.2 Purpose .....1</p> <p>101.3 Plans Required .....1</p> <p>101.4 Scope .....1</p> <p>101.5 Application to Existing Plumbing System .....2</p> <p>102.0 Organization and Enforcement .....2</p> <p>102.1 Authority Having Jurisdiction .....2</p> <p>102.2 Duties and Powers of the Authority Having Jurisdiction .....2</p> <p>102.3 Violations and Penalties .....3</p> <p>103.0 Permits and Inspections .....3</p> <p>103.1 Permits .....3</p> <p>103.2 Application for Permit .....3</p> <p>103.3 Permit Issuance .....4</p> <p>103.4 Fees .....5</p> <p>103.5 Inspections .....6</p> <p>103.6 Connection Approval .....7</p> <p>103.7 Unconstitutionality .....8</p> <p>103.8 Validity .....8</p> <p>Table 1-1 Plumbing Permit Fees .....9</p> <p><b>Chapter 2 Definitions</b> .....11</p> <p>201.0 General .....11</p> <p>202.0 Definition of Terms .....11</p> <p><b>Chapter 3 General Regulations</b> .....19</p> <p>301.0 Materials - Standards and Alternates ..19</p> <p>301.1 Minimum Standards .....19</p> <p>301.2 Alternate Materials and Methods Equivalency .....19</p> <p>302.0 Iron Pipe Size (IPS) Pipe .....20</p> <p>303.0 Disposal of Liquid Waste .....20</p> <p>304.0 Connections of Plumbing System Required .....20</p> <p>305.0 Sewers Required .....20</p> <p>306.0 Damage of Drainage System or Public Sewer .....20</p> <p>307.0 Industrial Wastes .....20</p> <p>308.0 Location .....20</p> <p>309.0 Improper Location .....20</p> <p>310.0 Workmanship .....21</p> <p>311.0 Prohibited Fittings and Practices ..21</p>	<p>312.0 Independent Systems .....21</p> <p>313.0 Protection of Piping, Materials, and Structures .....21</p> <p>314.0 Hangers and Supports .....22</p> <p>315.0 Trenching, Excavation and Backfill .....22</p> <p>316.0 Joints and Connections .....23</p> <p>317.0 Increases and Reducers .....24</p> <p>318.0 Food Handling Establishments .....24</p> <p>319.0 Test Gauges .....24</p> <p>320.0 Medical Gas and Vacuum Systems .25</p> <p><b>Chapter 4 Plumbing Fixtures and Fixture Fittings</b> .....27</p> <p>401.0 Materials - General Requirements .....27</p> <p>402.0 Water-Conserving Fixtures and Fittings .....27</p> <p>403.0 Materials - Alternates .....27</p> <p>404.0 Overflows .....27</p> <p>405.0 Strainers and Connections .....27</p> <p>406.0 Prohibited Fixtures .....28</p> <p>407.0 Special Fixtures and Specialties ...28</p> <p>408.0 Installation .....28</p> <p>409.0 Water Closets .....29</p> <p>410.0 Urinals .....29</p> <p>411.0 Flushing Devices for Water Closets and Urinals .....29</p> <p>412.0 Floor Drains and Shower Stalls ...29</p> <p>413.0 Minimum Number of Required Fixtures .....31</p> <p>414.0 Fixtures and Fixture Fittings for Persons with Disabilities .....32</p> <p>415.0 Whirlpool Bathtubs .....32</p> <p>416.0 Installation of Fixture Fittings .....32</p> <p>417.0 Bidets .....32</p> <p>418.0 Deleted .....32</p> <p>419.0 Future Fixtures .....32</p> <p>420.0 Shower and Tub/Shower Combination Control Valves .....33</p> <p>421.0 Limitation of Hot Water in Bathtubs .....33</p> <p>Table 4-1 Minimum Plumbing Facilities ....33</p>
---	---

TABLE OF CONTENTS

<b>Chapter 5 Water Heaters Part I</b> . . . . .	37	701.0	Materials	. . . . .	107
501.0 General	. . . . .	702.0	Fixture Unit Equivalents	. . . . .	109
502.0 Definitions	. . . . .	703.0	Size of Drainage Piping	. . . . .	109
503.0 Permits	. . . . .	Table 7-3	Drainage Fixture Unit Values	. . . . .	108
504.0 Inspection	. . . . .		(DFU)	. . . . .	108
505.0 Water Heater Requirements	. . . . .	Table 7-4	Discharge Capacity In Gallons per		
506.0 Oil-Burning and			Minute (Liters per Second) For		
Other Water Heater	. . . . .		Intermittent Flow Only	. . . . .	109
507.0 Air for Combustion and Ventilation	. . . . .	704.0	Fixture Connections (Drainage)	. . . . .	109
508.0 Other Water Heater		705.0	Joints and Connections	. . . . .	110
Installation Requirements	. . . . .	706.0	Changes in Direction of Drainage		
509.0 Equipment on Roofs	. . . . .		Flow	. . . . .	111
510.0 Venting of Equipment	. . . . .	707.0	Cleanouts	. . . . .	111
511.0 Sizing of Category I Venting Systems	. . . . .	708.0	Grade of Horizontal Drainage		
512.0 Direct-Vent Equipment	. . . . .		Piping	. . . . .	112
Part II Sizing of Venting Systems Serving		709.0	Gravity Drainage Required	. . . . .	113
Appliances Equipped with Draft		710.0	Drainage of Fixtures Located Below		
Hoods, Category I Appliances, and			the Next Upstream Manhole or Below		
Appliances Listed for Use with			the Main Sewer Level	. . . . .	113
Type B Vents	. . . . .	711.0	Suds Relief	. . . . .	114
	. . . . .	712.0	Testing	. . . . .	114
<b>Chapter 6 Water Supply and Distribution</b>	. . . . .	<b>Part II Building Sewers</b>	. . . . .	115	
601.0 Running Water Required	. . . . .	713.0	Sewer Required	. . . . .	115
602.0 Unlawful Connections	. . . . .	714.0	Damage to Public Sewer of Private		
603.0 Cross-Connection Control	. . . . .		Sewage Disposal System	. . . . .	115
604.0 Materials	. . . . .	715.0	Building Sewer Materials	. . . . .	115
605.0 Valves	. . . . .	716.0	Markings	. . . . .	115
606.0 Joints and Connections	. . . . .	717.0	Size of Building Sewers	. . . . .	116
607.0 Gravity Supply Tanks	. . . . .	718.0	Grade, Support, and Protection of		
608.0 Water Pressure, Pressure Regulators,			Building Sewers	. . . . .	116
Pressure Relief Valves, and Vacuum		719.0	Cleanouts	. . . . .	116
Relief Valves	. . . . .	720.0	Sewer and Water Pipes	. . . . .	116
609.0 Installation, Testing, Unions,		721.0	Location	. . . . .	117
and Location	. . . . .	722.0	Abandoned Sewers and Sewage		
Table 6-4 Water Supply Fixture Units (WSFU)			Disposal Facilities	. . . . .	118
and Minimum Fixture		723.0	Building Sewer Test	. . . . .	118
Branch Sizes	. . . . .	<b>Chapter 8 Indirect Wastes</b>	. . . . .	119	
Table 6-5 Fixture Unit Table for Determining		801.0	Indirect Wastes	. . . . .	119
Water Pipe and Meter Sizes	. . . . .	802.0	Approvals	. . . . .	119
610.0 Size of Potable Water Piping	. . . . .	803.0	Indirect Waste Piping	. . . . .	120
611.0 Drinking Water Treatment Units	. . . . .	804.0	Indirect Waste Receptors	. . . . .	120
<b>Chapter 7 Sanitary Drainage</b>	. . . . .	805.0	Pressure Drainage Connections	. . . . .	120
<b>Part I Drainage Systems</b>	. . . . .	806.0	Sterile Equipment	. . . . .	120

UNIFORM PLUMBING CODE

807.0	Appliances .....	120	1016.0	Sand Interceptors .....	130
808.0	Cooling Water .....	120	1017.0	Oil and Flammable Liquids Interceptors .....	130
809.0	Drinking Fountains .....	121			
810.0	Steam and Hot Water Drainage .. Condensers and Sumps .....	121	<b>Chapter 11 Storm Drainage .....</b>	<b>133</b>	
811.0	Chemical Wastes .....	121	1101.0	General .....	133
812.0	Clear Water Wastes .....	122	1102.0	Materials .....	135
813.0	Swimming Pools .....	122	1103.0	Traps on Storm Drains and Leaders .....	135
814.0	(Reserved) .....	122	1104.0	Leaders, Conductors, and Connections .....	135
815.0	Condensate Wastes and Control ..	122	1105.0	Roof Drains .....	135
			1106.0	Size of Leaders, Conductors, and Storm Drains .....	141
<b>Chapter 9 Vents .....</b>	<b>123</b>		1107.0	Values of Continuous Flow .....	141
901.0	Vents Required .....	123	1108.0	Controlled-Flow Roof Drainage ..	141
902.0	Vents Not Required .....	123	1109.0	Testing .....	142
903.0	Materials .....	123			
904.0	Size of Vents .....	123	<b>Chapter 12 Fuel Piping .....</b>	<b>145</b>	
905.0	Vent Pipe Grades and Connections .	124	1201.0	Scope of Gas Piping .....	145
906.0	Vent Termination .....	124	1202.0	General .....	145
907.0	Vent Stacks and Relief Vents .....	124	1203.0	Definitions .....	145
908.0	Vertical Wet Venting .....	125	1204.0	Inspection .....	146
909.0	Special Venting for Island Fixtures .	125	1205.0	Certificate of Inspection .....	146
910.0	Combination Waste and Vent Systems .....	125	1206.0	Authority to Render Gas Service .....	147
			1207.0	Authority to Disconnect .....	147
<b>Chapter 10 Traps and Interceptors .....</b>	<b>127</b>		1208.0	Temporary Use of Gas .....	147
1001.0	Traps Required .....	127	1209.0	Gas-Piping System Design, Materials, and Components .....	147
1002.0	Traps Protected by Vent Pipes .....	127	1210.0	(Reserved) .....	154
1003.0	Traps - Described .....	127	1211.0	Gas Piping Installation .....	154
1004.0	Traps - Prohibited .....	128	1212.0	Equipment Connections to Building Piping .....	161
1005.0	Trap Seals .....	128	1213.0	Liquefied Petroleum Gas Facilities and Piping .....	162
1006.0	Floor Drain Traps .....	128	1214.0	Pressure Testing and Inspection ..	162
1007.0	Trap Seal Protection .....	128	1215.0	Interconnections Between Gas Piping Systems .....	164
1008.0	Building Traps		1216.0	Required Gas Supply .....	164
1009.0	Industrial Interceptors (Clarifiers) and Separators .....	128	1217.0	Required Gas Piping Size .....	165
1010.0	Slaughterhouses, Packing Establishments, etc. ....	129		Table 12-7 to Table 12-23 .....	167
1011.0	Minimum Requirements for Auto Wash racks .....	129			
1012.0	Commercial and Industrial Laundries .....	129	<b>Chapter 13 Health Care Facilities and Medical Gas and Vacuum Systems .....</b>	<b>187</b>	
1013.0	Bottling Establishments .....	129			
1014.0	Grease Traps and Grease Interceptors .....	129			
1015.0	Food Waste Disposal and Dishwasher Prohibited .....	130			

## TABLE OF CONTENTS

<p><b>Part I Special Requirements for Health Care Facilities</b> .....187</p> <p>1301.0 Application .....187</p> <p>1302.0 Medical Gas and Vacuum Piping Systems -Installation Requirements ..187</p> <p>1303.0 Protrusions from Walls .....187</p> <p>1304.0 Psychiatric Patient Rooms .....187</p> <p>1305.0 Locations for Ice Storage .....187</p> <p>1306.0 Sterilizers .....187</p> <p>1307.0 Vapor Vents and Stacks for Sterilizers .....188</p> <p>1308.0 Aspirators .....188</p> <p><b>Part II Medical Gas and Vacuum System</b> ..188</p> <p>1309.0 Application .....188</p> <p>1310.0 Definitions .....188</p> <p>1311.0 General Requirements .....189</p> <p>1312.0 Plan Review .....190</p> <p>1313.0 System Performance .....191</p> <p>1314.0 (Reserved) .....191</p> <p>1315.0 Required Pipe Sizing .....191</p> <p>1316.0 Workmanship .....191</p> <p>1317.0 Materials .....192</p> <p>1318.0 Cleaning for Medical Gas Piping Systems .....194</p> <p>1319.0 Installation of Piping .....194</p> <p>1320.0 Joints .....195</p> <p>1321.0 Valves - Requirements, Locations, and Labeling .....197</p> <p>1322.0 Pressure Regulating Equipment ..199</p> <p>1323.0 Station Outlets/Inlets .....199</p> <p>1324.0 Labeling and Identification .....199</p> <p>1325.0 Alarms .....200</p> <p>1326.0 Medical Air System .....200</p> <p>1327.0 Medical Vacuum Pump System ..201</p> <p>1328.0 (Reserved) .....202</p> <p>1329.0 Testing and Inspection .....202</p> <p>1330.0 (Reserved) .....204</p> <p>1331.0 System Certification .....204</p> <p><b>Chapter 14 Mandatory Referenced Standards</b> .....211</p> <p>Table 14-1 Standards for Materials, Equipment, Joints, and Connections .....211</p> <p>Table 14-1 Index .....230</p>	<p>Abbreviation in Table 14-1 .....236</p> <p><b>Chapter 15 Firestop Protection</b> .....237</p> <p>1501.0 General Requirements .....237</p> <p>1502.0 Plans and Specifications .....237</p> <p>1503.0 Installation .....237</p> <p>1504.0 Definitions .....237</p> <p>1505.0 Combustion Installations .....237</p> <p>1506.0 Non-Combustible Piping Installation .....237</p> <p>1507.0 Required Inspection .....238</p> <p><b>Appendices Table of Contents</b> .....239</p> <p>Appendix A Recommended Rules for Sizing the Water Supply System .....241</p> <p>Appendix B Explanatory Notes on Combination Waste and Vent Systems .....257</p> <p>Appendix C Deleted</p> <p>Appendix D Sizing Stormwater Drainage Systems .....259</p> <p>Appendix E Manufactured/Mobile Home Parks and Recreational Vehicle Parks .....267</p> <p>Appendix F (Reserved)</p> <p>Appendix G Graywater Systems for Single-Family Dwellings .....279</p> <p>Appendix H Recommended Procedures for Design, Construction, and Installation of Commercial Kitchen Grease Interceptors .....289</p> <p>Appendix I Installation Standards Table of Content .....293</p> <p>Appendix J Reclaimed Water Systems for Non-Residential Buildings .....397</p> <p>Appendix K Private Sewage Disposal Systems ..401</p> <p>Appendix L Alternate Plumbing Systems .....413</p> <p><b>Useful Tables</b> .....419</p> <p><b>Index</b> .....427</p>
---	--

UNIFORM PLUMBING CODE



# CHAPTER 1

## ADMINISTRATION

### 101.0 Title, Scope, and General.

#### 101.1 Title.

This document shall be known as the "Uniform Plumbing Code," may be cited as such, and will be referred to herein as "this code."

#### 101.2 Purpose.

This code is an ordinance providing minimum requirements and standards for the protection of the public health, safety, and welfare.

#### 101.3 Plans Required.

The Authority Having Jurisdiction may require the submission of plans, specifications, drawings, and such other information as the Authority Having Jurisdiction may deem necessary, prior to the commencement of, and at any time during the progress of, any work regulated by this code.

The issuance of a permit upon plans and specifications shall not prevent the Authority Having Jurisdiction from thereafter requiring the correction of errors in said plans and specifications or from preventing construction operations being carried on thereunder when in violation of this code or of any other pertinent ordinance or from revoking any certificate of approval when issued in error.

#### 101.4 Scope.

**101.4.1** The provisions of this code shall apply to the erection, installation, alteration, repair, relocation, replacement, addition to, use, or maintenance of plumbing systems within this jurisdiction.

##### 101.4.1.1 Repairs and Alterations.

**101.4.1.1.1** In existing buildings or premises in which plumbing installations are to be altered, repaired, or renovated, deviations from the provisions of this code are permitted, provided such deviations are found to be necessary and are first approved by the Authority Having Jurisdiction.

**101.4.1.1.2** Existing building sewers and building drains may be used in connection with new buildings or new plumbing and drainage work only when they are found on examination and test to conform in all respects to the requirements governing new work, and the proper Authority Having Jurisdiction shall notify the owner to

make any changes necessary to conform to this code. No building or part thereof, shall be erected or placed over any part of a drainage system which is constructed of materials other than those approved elsewhere in this code for use under or within a building.

**101.4.1.1.3** All openings into a drainage or vent system, excepting those openings to which plumbing fixtures are properly connected or which constitute vent terminals, shall be permanently plugged or capped in an approved manner, using the appropriate materials required by this code.

**101.4.1.2 Maintenance.** The plumbing and drainage system of any premises under the jurisdiction of the Authority Having Jurisdiction shall be maintained in a sanitary and safe operating condition by the owner or the owner's agent.

**101.4.1.3 Existing Construction.** No provision of this code shall be deemed to require a change in any portion of a plumbing or drainage system or any other work regulated by this code in or on an existing building or lot when such work was installed and is maintained in accordance with law in effect prior to the effective date of this code, except when any such plumbing or drainage system or other work regulated by this code is determined by the Authority Having Jurisdiction to be in fact dangerous, unsafe, insanitary, or a nuisance and a menace to life, health, or property.

**101.4.1.4 Conflicts Between Codes.** When the requirements within the jurisdiction of this plumbing code conflict with the requirements of the mechanical code, this code shall prevail.

**101.4.2** Additions, alterations, repairs, and replacement of plumbing systems shall comply with the provisions for new systems except as otherwise provided in Section 101.5.

**101.4.3** The provisions in the appendices are intended to supplement the requirements of this code and shall not be considered part of this code unless formally adopted as such.



**101.5 Application to Existing Plumbing System.****101.5.1 Additions, Alterations, or Repairs.**

Additions, alterations, or repairs may be made to any plumbing system without requiring the existing plumbing system to comply with all the requirements of this code, provided the addition, alteration, or repair conforms to that required for a new plumbing system. Additions, alterations, or repairs shall not cause an existing system to become unsafe, insanitary, or overloaded.

**101.5.2 Health and Safety.** Whenever compliance with all the provisions of this code fails to eliminate or alleviate a nuisance, or any other dangerous or insanitary condition which may involve health or safety hazards, the owner or the owner's agent shall install such additional plumbing and drainage facilities or shall make such repairs or alterations as may be ordered by the Authority Having Jurisdiction.

**101.5.3 Existing Installation.** Plumbing systems lawfully in existence at the time of the adoption of this code may have their use, maintenance, or repair continued if the use, maintenance, or repair is in accordance with the original design and location and no hazard to life, health, or property has been created by such plumbing system.

**101.5.4 Changes in Building Occupancy.**

Plumbing systems which are a part of any building or structure undergoing a change in use or occupancy, as defined in the Building code, shall comply to all requirements of this code which may be applicable to the new use or occupancy.

**101.5.5 Maintenance.** All plumbing systems, materials, and appurtenances, both existing and new, and all parts thereof shall be maintained in proper operating condition. All devices or safeguards required by this code shall be maintained in conformance with the code edition under which installed. The owner or the owner's designated agent shall be responsible for maintenance of plumbing systems. To determine compliance with this subsection, the Authority Having Jurisdiction may cause any plumbing system to be reinspected.

**101.5.6 Moved Buildings.** Plumbing systems which are part of buildings or structures moved into this jurisdiction shall comply with the provisions of this code for new installations except as provided for in Section 103.5.5.2.

**102.0 Organization and Enforcement.****102.1 Authority Having Jurisdiction.**

The Authority Having Jurisdiction shall be the Authority duly appointed to enforce this code.

**102.2 Duties and Powers of the Authority Having Jurisdiction.**

**102.2.1** The Authority Having Jurisdiction may appoint such assistants, deputies, inspectors, or other employees as are necessary to carry out the functions of the department and this code.

**102.2.2 Right of Entry.** Whenever it is necessary to make an inspection to enforce the provisions of this code, or whenever the Authority Having Jurisdiction has reasonable cause to believe that there exists in any building or upon any premises, any condition or violation of this code which makes the building or premises unsafe, insanitary, dangerous, or hazardous, the Authority Having Jurisdiction may enter the building or premises at all reasonable times to inspect or to perform the duties imposed upon the Authority Having Jurisdiction by this code, provided that if such building or premises is occupied, the Authority Having Jurisdiction shall present credentials to the occupant and request entry. If such building or premises is unoccupied, the Authority Having Jurisdiction shall first make a reasonable effort to locate the owner or other person having charge or control of the building or premises and request entry. If entry is refused, the Authority Having Jurisdiction has recourse to every remedy provided by law to secure entry.

When the Authority Having Jurisdiction shall have first obtained a proper inspection warrant or other remedy provided by law to secure entry, no owner, occupant, or person having charge, care, or control of any building or premises shall fail or neglect, after proper request is made as herein provided, to promptly permit entry herein by the Authority Having Jurisdiction for the purpose of inspection and examination pursuant to this code.

**102.2.3 Stop Orders.** Whenever any work is being done contrary to the provisions of this code, the Authority Having Jurisdiction may order the work stopped by notice in writing served on any persons engaged in the doing or causing such work to be done, and any such persons shall forthwith stop work until authorized by the Authority Having Jurisdiction to proceed with the work.

**102.2.4 Authority to Disconnect Utilities in Emergencies.** The Authority Having Jurisdiction shall have the authority to

disconnect a plumbing system to a building, structure, or equipment regulated by this code in case of emergency where necessary to eliminate an immediate hazard to life or property.

**102.2.5 Authority to Condemn.** Whenever the Authority Having Jurisdiction ascertains that any plumbing system or portion thereof, regulated by this code, has become hazardous to life, health, property, or has become insanitary, the Authority Having Jurisdiction shall order in writing that such plumbing either be removed or placed in a safe or sanitary condition, as appropriate. The order shall fix a reasonable time limit for compliance. No person shall use or maintain defective plumbing after receiving such notice.

When such plumbing system is to be disconnected, written notice shall be given. In cases of immediate danger to life or property, such disconnection may be made immediately without such notice.

**102.2.6 Liability.** The Authority Having Jurisdiction charged with the enforcement of this code, acting in good faith and without malice in the discharge of the Authority Having Jurisdiction's duties, shall not thereby be rendered personally liable for any damage that may accrue to persons or property as a result of any act or by reason of any act or omission in the discharge of duties. A suit brought against the Authority Having Jurisdiction or employee because of such act or omission performed in the enforcement of any provision of this code shall be defended by legal counsel provided by this jurisdiction until final termination of such proceedings.

### **102.3 Violations and Penalties.**

**102.3.1 Violations.** It shall be unlawful for any person, firm, or corporation to erect, construct, enlarge, alter, repair, move, improve, remove, convert, demolish, equip, use, or maintain any plumbing or permit the same to be done in violation of this code.

**102.3.2 Penalties.** Any person, firm, or corporation violating any provision of this code shall be deemed guilty of a misdemeanor, and upon conviction thereof, shall be punishable by a fine and/or imprisonment set forth by the governing laws of the jurisdiction. Each separate day or any portion thereof, during which any violation of this code occurs or continues, shall be deemed to constitute a separate offense.

## **103.0 Permits and Inspections.**

### **103.1 Permits.**

**103.1.1 Permits Required.** It shall be unlawful for any person, firm, or corporation to make any installation, alteration, repair, replacement, or remodel any plumbing system regulated by this code except as permitted in Section 103.1.2, or to cause the same to be done without first obtaining a separate plumbing permit for each separate building or structure.

**103.1.2 Exempt Work.** A permit shall not be required for the following:

**103.1.2.1** The stopping of leaks in drains, soil, waste, or vent pipe, provided, however, that should any trap, drainpipe, soil, waste, or vent pipe become defective and it becomes necessary to remove and replace the same with new material, the same shall be considered as new work and a permit shall be procured and inspection made as provided in this code.

**103.1.2.2 (1)** The clearing of stoppages, including the removal and reinstallation of water closets, or

(2) the repairing of leaks in pipes, valves, or fixtures, provided such repairs do not involve or require the replacement or rearrangement of valves, pipes, or fixtures.

Exemption from the permit requirements of this code shall not be deemed to grant authorization for any work to be done in violation of the provisions of the code or any other laws or ordinances of this jurisdiction.

**103.1.3 Licensing.** As a result of an agreement between the Department of Housing and Urban Development (HUD) and IAPMO, the requirements for licensing have been removed from this section of the UPC. Provision for licensing shall be determined by the Authority Having Jurisdiction.

### **103.2 Application for Permit.**

**103.2.1 Application.** To obtain a permit, the applicant shall first file an application therefor in writing on a form furnished by the Authority Having Jurisdiction for that purpose. Every such application shall:

**103.2.1.1** Identify and describe the work to be covered by the permit for which application is made.

**103.2.1.2** Describe the land upon which the proposed work is to be done by legal description, street address, or similar

description that will readily identify and definitely locate the proposed building or work.

**103.2.1.3** Indicate the use or occupancy for which the proposed work is intended.

**103.2.1.4** Be accompanied by plans, diagrams, computations, and other data as required in Section 103.2.2.

**103.2.1.5** Be signed by permittee or the permittee's authorized agent, who may be required to submit evidence to indicate such authority.

**103.2.1.6** Give such other data and information as may be required by the Authority Having Jurisdiction.

**103.2.2 Plans and Specifications.** Plans, engineering calculations, diagrams, and other data shall be submitted in one or more sets with each application for a permit. The Authority Having Jurisdiction may require plans, computations, and specifications to be prepared by and the plumbing designed by an engineer and/or architect licensed by the state to practice as such.

**Exception:** The Authority Having Jurisdiction may waive the submission of plans, calculations, or other data if the Authority Having Jurisdiction finds that the nature of the work applied for is such that reviewing of plans is not necessary to obtain compliance within the code.

**103.2.3 Information on Plans and Specifications.** Plans and specifications shall be drawn to scale upon substantial paper or cloth and shall be of sufficient clarity to indicate the location, nature, and extent of the work proposed and show in detail that it will conform to the provisions of this code and relevant laws, ordinances, rules, and regulations.

### **103.3 Permit issuance.**

**103.3.1 Issuance.** The application, plans, and specifications and other data filed by an applicant for a permit shall be reviewed by the Authority Having Jurisdiction. Such plans may be reviewed by other departments of this jurisdiction to verify compliance with applicable laws under their jurisdiction. If the Authority Having Jurisdiction finds that the work described in an application for permit and the plans, specifications, and other data filed therewith conform to the requirements of the code and other pertinent laws and ordinances, and that the fees specified in Section 103.4 have

been paid, the Authority Having Jurisdiction shall issue a permit therefor to the applicant.

When the Authority Having Jurisdiction issues the permit where plans are required, the Authority Having Jurisdiction shall endorse in writing or stamp the plans and specifications "APPROVED." Such approved plans and specifications shall not be changed, modified, or altered without authorization from the Authority Having Jurisdiction, and all work shall be done in accordance with approved plans.

The Authority Having Jurisdiction may issue a permit for the construction of a part of a plumbing system before the entire plans and specifications for the whole system have been submitted or approved, provided adequate information and detailed statements have been filed complying with all pertinent requirements of this code. The holder of such permit may proceed at the holder's risk without assurance that the permit for the entire building, structure, or plumbing system will be granted.

**103.3.2 Retention of Plans.** One set of approved plans, specifications, and computations shall be retained by the Authority Having Jurisdiction until final approval of the work covered therein. One set of approved plans and specifications shall be returned to the applicant, and said set shall be kept on the site of the building or work at all times during which the work authorized thereby is in progress.

**103.3.3 Validity of Permit.** The issuance of a permit or approval of plans and specifications shall not be construed to be a permit for, or an approval of, any violation of any of the provisions of this code or of any other ordinance of the jurisdiction. No permit presuming to give authority to violate or cancel the provisions of this code shall be valid.

The issuance of a permit based upon plans, specifications, or other data shall not prevent the Authority Having Jurisdiction from thereafter requiring the correction of errors in said plans, specifications, and other data or from preventing building operations being carried on thereunder when in violation of this code or of other ordinances of this jurisdiction.

**103.3.4 Expiration.** Every permit issued by the Authority Having Jurisdiction under the provisions of this code shall expire by limitation and become null and void if the work authorized by such permit is not commenced within one hundred eighty (180) days from the date of such permit, or if the work authorized by

such permit is suspended or abandoned at any time after the work is commenced for a period of one hundred eighty (180) days. Before such work can be recommenced, a new permit shall first be obtained to do so, and the fee therefor shall be one-half the amount required for a new permit for such work, provided no changes have been made or will be made in the original plans and specifications for such work, and provided further that such suspensions or abandonment has not exceeded one year.

Any permittee holding an unexpired permit may apply for an extension of the time within which work may commence under that permit when the permittee is unable to commence work within the time required by this section for good and satisfactory reasons. The Authority Having Jurisdiction may extend the time for action by the permittee for a period not exceeding one hundred eighty (180) days upon written request by the permittee showing that circumstances beyond the control of the permittee have prevented action from being taken. No permit shall be extended more than once. In order to renew action on a permit after expiration, the permittee shall pay a new full permit fee.

**103.3.5 Suspension or Revocation.** The Authority Having Jurisdiction may, in writing, suspend or revoke a permit issued under the provisions of this code whenever the permit is issued in error or on the basis of incorrect information supplied or in violation of other ordinance or regulation of the jurisdiction.

#### **103.4 Fees.**

**103.4.1 Permit Fees.** Fees shall be assessed in accordance with the provisions of this section and as set forth in the fee schedule Table 1-1. The fees are to be determined and adopted by this jurisdiction.

**103.4.2 Plan Review Fees.** When a plan or other data is required to be submitted by Section 103.2.2, a plan review fee shall be paid at the time of submitting plans and specifications for review.

The plan review fees for plumbing work shall be determined and adopted by this jurisdiction.

The plan review fees specified in this subsection are separate fees from the permit fees specified in this section and are in addition to the permit fees.

When plans are incomplete or changed so as to require additional review, a fee shall be charged at the rate shown in Table 1-1.

#### **103.4.3 Expiration of Plan Review.**

Applications for which no permit is issued within one hundred eighty (180) days following the date of application shall expire by limitation, and plans and other data submitted for review may thereafter be returned to the applicant or destroyed by the Authority Having Jurisdiction. The Authority Having Jurisdiction may exceed the time for action by the applicant for a period not to exceed one hundred eighty (180) days upon request by the applicant showing that circumstances beyond the control of the applicant have prevented action from being taken. No application shall be extended more than once. In order to renew action on an application after expiration, the applicant shall resubmit plans and pay a new plan review fee.

#### **103.4.4 Investigation Fees: Work Without a Permit.**

**103.4.4.1** Whenever any work for which a permit is required by this code has been commenced without first obtaining said permit, a special investigation shall be made before a permit may be issued for such work.

**103.4.4.2** An investigation fee, in addition to the permit fee, shall be collected whether or not a permit is then or subsequently issued. The investigation fee shall be equal to the amount of the permit fee that would be required by this code if a permit were to be issued. The payment of such investigation fee shall not exempt any person from compliance with all other provisions of this code, nor from any penalty prescribed by law.

#### **103.4.5 Fee Refunds.**

**103.4.5.1** The Authority Having Jurisdiction may authorize the refunding of any fee paid hereunder which was erroneously paid or collected.

**103.4.5.2** The Authority Having Jurisdiction may authorize the refunding of not more than a percentage, as determined by this jurisdiction when no work has been done under a permit issued in accordance with this code.

**103.4.5.3** The Authority Having Jurisdiction shall not authorize the refunding of any fee paid except upon written application filed by the original permittee not later than one hundred eighty (180) days after the date of fee payment.

**103.5 Inspections.**

**103.5.1 General.** All plumbing systems for which a permit is required by this code shall be inspected by the Authority Having Jurisdiction. No portion of any plumbing system shall be concealed until inspected and approved. Neither the Authority Having Jurisdiction nor the jurisdiction shall be liable for expense entailed in the removal or replacement of material required to permit inspection. When the installation of a plumbing system is complete, an additional and final inspection shall be made. Plumbing systems regulated by this code shall not be connected to the water, energy fuel supply, or the sewer system until authorized by the Authority Having Jurisdiction.

**103.5.1.1 Inspection.** No water supply system or portion thereof shall be covered or concealed until it first has been tested, inspected, and approved.

**103.5.1.2 Scope.** All new plumbing work and such portions of existing systems as may be affected by new work, or any changes, shall be inspected by the Authority Having Jurisdiction to insure compliance with all the requirements of this code and to assure that the installation and construction of the plumbing system is in accordance with approved plans.

**103.5.1.3 Covering or Using.** No plumbing or drainage system, building sewer, private sewer disposal system, or part thereof, shall be covered, concealed, or put into use until it has been tested, inspected, and accepted as prescribed in this code.

**103.5.1.4 Uncovering.** If any drainage or plumbing system, building sewer, private sewage disposal system, or part thereof, which is installed, altered, or repaired, is covered or concealed before being inspected, tested, and approved as prescribed in this code, it shall be uncovered for inspection after notice to uncover the work has been issued to the responsible person by the Authority Having Jurisdiction.

**103.5.2 Operation of Plumbing Equipment.** The requirements of this section shall not be considered to prohibit the operation of any plumbing installed to replace existing

equipment or fixtures serving an occupied portion of the building in the event a request for inspection of such equipment or fixture has been filed with the Authority Having Jurisdiction not more than seventy-two (72) hours after such replacement work is completed, and before any portion of such plumbing system is concealed by any permanent portion of the building.

**103.5.3 Testing of Systems.** All plumbing systems shall be tested and approved as required by this code or the Authority Having Jurisdiction.

**103.5.3.1 Test.** Tests shall be conducted in the presence of the Authority Having Jurisdiction or the Authority Having Jurisdiction's duly appointed representative.

**103.5.3.2 Test Waived.** No test or inspection shall be required where a plumbing system, or part thereof, is set up for exhibition purposes and has no connection with a water or drainage system.

**103.5.3.3 Exceptions.** In cases where it would be impractical to provide the required water or air tests, or for minor installations and repairs, the Authority Having Jurisdiction may make such inspection as deemed advisable in order to be assured that the work has been performed in accordance with the intent of this code.

**103.5.3.4 Protectively Coated Pipe.** Protectively coated pipe shall be inspected and tested, and any visible void, damage, or imperfection to the pipe coating shall be repaired to comply with Section 313.0 (see IAPMO IS-13, listed in Appendix I).

**103.5.3.5 Tightness.** Joints and connections in the plumbing system shall be gastight and watertight for the pressures required by test.

**103.5.4 Inspection Requests.** It shall be the duty of the person doing the work authorized by a permit to notify the Authority Having Jurisdiction that such work is ready for inspection. The Authority Having Jurisdiction may require that every request for inspection be filed at least one working day before such inspection is desired. Such request may be in writing or by telephone, at the option of the Authority Having Jurisdiction.

It shall be the duty of the person requesting inspections required by this code to provide access to and means for proper inspection of such work.

**103.5.4.1 Advance Notice.** It shall be the duty of the person doing the work authorized by the permit to notify the Authority Having Jurisdiction, orally or in writing, that said work is ready for inspection. Such notification shall be given not less than twenty-four (24) hours before the work is to be inspected.

**103.5.4.2 Responsibility.** It shall be the duty of the holder of a permit to make sure that the work will stand the test prescribed before giving the notification.

The equipment, material, and labor necessary for inspection or tests shall be furnished by the person to whom the permit is issued or by whom inspection is requested.

**103.5.5 Other Inspections.** In addition to the inspections required by this code, the Authority Having Jurisdiction may require other inspections of any plumbing work to ascertain compliance with the provisions of this code and other laws which are enforced by the Authority Having Jurisdiction.

**103.5.5.1 Defective Systems.** An air test shall be used in testing the sanitary condition of the drainage or plumbing system of any building premises when there is reason to believe that it has become defective. In buildings or premises condemned by the proper Authority Having Jurisdiction because of an insanitary condition of the plumbing system or part thereof, the alterations in such system shall conform to the requirements of this code.

**103.5.5.2 Moved Structures.** All parts of the plumbing systems of any building or part thereof that is moved from one foundation to another, or from one location to another, shall be completely tested as prescribed elsewhere in this section for new work, except that walls or floors need not be removed during such test when other equivalent means of inspection acceptable to the Authority Having Jurisdiction are provided.

**103.5.6 Reinspections.** A reinspection fee may be assessed for each inspection or reinspection when such portion of work for which inspection is called is not complete or when required corrections have not been made.

This provision is not to be interpreted as requiring reinspection fees the first time a job is rejected for failure to comply with the requirements of this code, but as controlling the practice of calling for inspections before the job is ready for inspection or reinspection.

Reinspection fees may be assessed when the approved plans are not readily available to the inspector, for failure to provide access on the date for which the inspection is requested, or for deviating from plans requiring the approval of the Authority Having Jurisdiction.

To obtain reinspection, the applicant shall file an application therefor in writing upon a form furnished for that purpose and pay the reinspection fee in accordance with Table 1-1.

In instances where reinspection fees have been assessed, no additional inspection of the work will be performed until the required fees have been paid.

**103.5.6.1 Corrections.** Notices of correction or violation shall be written by the Authority Having Jurisdiction and may be posted at the site of the work or mailed or delivered to the permittee or his authorized representative. Refusal, failure, or neglect to comply with any such notice or order within ten (10) days of receipt thereof, shall be considered a violation of this code and shall be subject to the penalties set forth elsewhere in this code for violations.

**103.5.6.2 Retesting.** If the Authority Having Jurisdiction finds that the work will not pass the test, necessary corrections shall be made and the work shall then be resubmitted for test or inspection.

**103.5.6.3 Approval.** Upon the satisfactory completion and final test of the plumbing system, a certificate of approval shall be issued by the Authority Having Jurisdiction to the permittee on demand.

## 103.6 Connection Approval.

**103.6.1 Energy Connections.** No person shall make connections from a source of energy or fuel to any plumbing system or equipment regulated by this code and for which a permit is required until approved by the Authority Having Jurisdiction.

**103.6.2 Other Connections.** No person shall make connection from any water-supply line or shall connect to any sewer system regulated by this code and for which a permit is required until approved by the Authority Having Jurisdiction.

**103.6.3 Temporary Connections.** The Authority Having Jurisdiction may authorize temporary connection of the plumbing equipment to the source of energy or fuel for the purpose of testing the equipment.

### **103.7 Unconstitutionally.**

**103.7.1** If any section, subsection, sentence, clause, or phrase of this code is, for any reason, held to be unconstitutional, such decision shall not affect the validity of the remaining portions of this code. The Legislative Body hereby declares that it would have passed this code, and each section, subsection, sentence, clause, or phrase thereof, irrespective of the fact that many one or more sections, subsections, sentences, clauses, and phrase to declared unconstitutional.

### **103.8 Validity**

**103.8.1** If any provision of this code, or the application thereof to any person or circumstance, is held invalid, the remainder of the code, or the application of such provision to other persons or circumstances, shall not be affected thereby.

**103.8.2** Wherever in this code reference is made to an appendix, the provisions in the appendix shall not apply unless specifically adopted.

**TABLE 1-1**  
Plumbing Permit Fees

**Permit Issuance**

- 1. For issuing each permit .....\*
- 2. For issuing each supplemental permit.....\*

**Unit Fee Schedule** (in addition to items 1 and 2 above)

- 1. For each plumbing fixture on one trap or a set of fixtures on one trap (including water, drainage piping and backflow protection therefor).....\*
- 2. For each building sewer and each trailer park sewer.....\*
- 3. Rainwater systems – per drain (inside building).....\*
- 4. For each cesspool (where permitted).....\*
- 5. For each private sewage disposal system.....\*
- 6. For each water heater and/or vent.....\*
- 7. For each gas-piping system of one to five outlets.....\*
- 8. For each additional gas piping system outlet, per outlet.....\*
- 9. For each industrial waste pretreatment interceptor including its trap and vent, except kitchen-type grease interceptors functioning as fixture traps.....\*
- 10. For each installation, alteration or repair of water piping and/or water treating equipment, each ...\*
- 11. For each repair or alteration of drainage or vent piping, each fixture.....\*
- 12. For each lawn sprinkler system on any one meter including backflow protection devices therefor.....\*
- 13. For atmospheric-type vacuum breakers not included in item 12:
  - 1 to 5.....\*
  - over 5, each.....\*
- 14. For each backflow protective device other than atmospheric type vacuum breakers:
  - 2 inch (51 mm) diameter and smaller.....\*
  - over 2 inch (51 mm) diameter.....\*
- 15. For each graywater system.....\*
- 16. For initial installation and testing for a reclaimed water system.....\*
- 17. For each annual cross-connection testing of a reclaimed water system (excluding initial test).....\*
- 18. For each medical gas piping system serving one to five inlet(s)/outlet(s) for a specific gas.....\*
- 19. For each additional medical gas inlet(s)/outlet(s).....\*

**Other Inspections and Fees**

- 1. Inspections outside of normal business hours.....\*
- 2. Reinspection fee.....\*
- 3. Inspections for which no fee is specifically indicated.....\*
- 4. Additional plan review required by changes, additions or revisions to approved plans (minimum charge – one-half hour).....\*

\* Jurisdiction will indicate their fees here.





## CHAPTER 2

### DEFINITIONS

#### 201.0 General.

For the purpose of this code, the following terms have the meanings indicated in this chapter.

No attempt is made to define ordinary words which are used in accordance with their established dictionary meanings, except where a word has been used loosely and it is necessary to define its meaning as used in this code to avoid misunderstanding.

The definitions of terms are arranged alphabetically according to the first word of the term.

#### 202.0 Definition of Terms.

##### 203.0

– A –

**ABS** – Acrylonitrile-butadiene-styrene.

**Accessible** – When applied to a fixture, connection, appliance, or equipment, “accessible” means having access thereto, but which first may require the removal of an access panel, door, or similar obstruction. “Readily accessible” means direct access without the necessity of removing any panel, door, or similar obstruction.

**Airbreak** – A physical separation which may be a low inlet into the indirect waste receptor from the fixture, appliance, or device indirectly connected.

**Air Chamber** – A pressure surge-absorbing device operating through the compressibility of air.

**Airgap, Drainage** – The unobstructed vertical distance through the free atmosphere between the lowest opening from any pipe, plumbing fixture, appliance, or appurtenance conveying waste to the flood level rim of the receptor.

**Airgap, Water Distribution** – The unobstructed vertical distance through the free atmosphere between the lowest opening from any pipe or faucet conveying potable water to the flood level rim of any tank, vat, or fixture.

**Anchors** – See Supports.

**Approved** – Acceptable to the Authority Having Jurisdiction.

**Approved Testing Agency** – An organization primarily established for purposes of testing to approved standards and approved by the Authority Having Jurisdiction.

**Area Drain** – A receptor designed to collect surface or storm water from an open area.

**Aspirator** – A fitting or device supplied with water

or other fluid under positive pressure which passes through an integral orifice or constriction, causing a vacuum.

**Authority Having Jurisdiction** – The organization, office, or individual responsible for enforcing the requirements of a code or standard, or for approving equipment, materials, installations, or procedures. The Authority Having Jurisdiction shall be a federal, state, local, or other regional department or an individual such as a plumbing official; mechanical official; labor department official, health department official, building official or others having statutory authority. In the absence of a statutory authority, the Authority Having Jurisdiction may be some other responsible party. This definition shall include the Authority Having Jurisdiction’s duly authorized representative.

##### 204.0

– B –

**Backflow** – The flow of water or other liquids, mixtures, or substances into the distributing pipes of a potable supply of water from any sources other than its intended source. See Back-Siphonage, Back-Pressure Backflow.

**Backflow Connection** – Any arrangement whereby backflow can occur.

**Back-Pressure Backflow** – Backflow due to an increased pressure above the supply pressure, which may be due to pumps, boilers, gravity, or other sources of pressure.

**Backflow Preventer** – A device or means to prevent backflow into the potable water system.

**Back-Siphonage** – The flowing back of used, contaminated, or polluted water from a plumbing fixture or vessel into a water supply pipe due to a pressure less than atmospheric in such pipe. See Backflow.

**Backwater Valve** – A device installed in a drainage system to prevent reverse flow.

**Bathroom** – A room equipped with a shower or bathtub.

**Battery of fixtures** – Any group of two (2) or more similar, adjacent fixtures which discharge into a common horizontal waste or soil branch.

**Boiler Blowoff** – An outlet on a boiler to permit emptying or discharge of sediment.

**Branch** – Any part of the piping system other than a main, riser, or stack.

**Branch, Fixture** – See Fixture Branch.

**Branch, Horizontal** – See Horizontal Branch.

**Branch Vent** – A vent connecting one or more individual vents with a vent stack or stack vent.

**Building** – A structure built, erected, and framed of component structural parts designed for the housing, shelter, enclosure, or support of persons, animals, or property of any kind.

**Building Drain** – That part of the lowest piping of a drainage system which receives the discharge from soil, waste, and other drainage pipes inside the walls of the building and conveys it to the building sewer beginning two (2) feet (610 mm) outside the building wall.

**Building Drain (Sanitary)** – A building drain which conveys sewage only.

**Building Drain (Storm)** – A building drain which conveys storm water or other drainage, but no sewage.

**Building Sewer** – That part of the horizontal piping of a drainage system which extends from the end of the building drain and which receives the discharge of the building drain and conveys it to a public sewer, private sewer, private sewage disposal system, or other point of disposal.

**Building Sewer (Combined)** – A building sewer which conveys both sewage and storm water or other drainage.

**Building Sewer (Sanitary)** – A building sewer which conveys sewage only.

**Building Sewer (Storm)** – A building sewer which conveys storm water or other drainage, but no sewage.

**Building Subdrain** – That portion of a drainage system which does not drain by gravity into the building sewer.

**Building Supply** – The pipe carrying potable water from the water meter or other source of water supply to a building or other point of use or distribution on the lot. Building supply shall also mean water service.

## 205.0

### – C –

**Certified Backflow Assembly Tester** – A person who has shown competence to test and maintain backflow assemblies to the satisfaction of the Authority Having Jurisdiction.

**Cesspool** – A lined excavation in the ground which receives the discharge of a drainage system or part thereof, so designed as to retain the organic matter and solids discharging therein, but permitting the liquids to seep through the bottom and sides.

**Chemical Waste** – See Special Wastes.

**Clarifier** – See Interceptor.

**Clear Water Waste** – Cooling water and condensate drainage from refrigeration and air-conditioning equipment; cooled condensate from steam heating systems; cooled boiler blowdown water.

**Clinic Sink** – A sink designed primarily to receive wastes from bedpans and having a flush rim, an integral trap with a visible trap seal, and the same flushing and cleansing characteristics as a water closet.

**Code** – A standard that is an extensive compilation of provisions covering broad subject matter or that is suitable for adoption into law independently of other codes and standards.

**Combination Thermostatic/Pressure Balancing Valve** – A mixing valve which senses outlet temperature and incoming hot and cold water pressure and compensates for fluctuations in incoming hot and cold water temperatures and/or pressures to stabilize outlet temperatures.

**Combination Waste and Vent System** – A specially designed system of waste piping embodying the horizontal wet venting of one or more sinks or floor drains by means of a common waste and vent pipe, adequately sized to provide free movement of air above the flow line of the drain.

**Combined Building Sewer** – See Building Sewer (Combined).

**Common** – That part of a plumbing system which is so designed and installed as to serve more than one (1) appliance, fixture, building, or system.

**Conductor** – A pipe inside the building which conveys storm water from the roof to a storm drain, combined building sewer, or other approved point of disposal.

**Confined Space** – A room or space having a volume less than fifty (50) cubic feet per 1000 Btu/h (1.4 m<sup>3</sup>/293 W) of the aggregate input rating of all fuel-burning appliances installed in that space.

**Contamination** – An impairment of the quality of the potable water which creates an actual hazard to the public health through poisoning or through the spread of disease by sewage, industrial fluids, or waste. Also defined as High Hazard.

**Continuous Vent** – A vertical vent that is a continuation of the drain to which it connects.

**Continuous Waste** – A drain connecting the compartments of a set of fixtures to a trap or connecting other permitted fixtures to a common trap.

**CPVC** – Chlorinated Poly (Vinyl Chloride).

**Critical Level** – The critical level (C-L or C/L) marking on a backflow prevention device or vacuum breaker is a point conforming to approved standards

and established by the testing laboratory (usually stamped on the device by the manufacturer) which determines the minimum elevation above the flood level rim of the fixture or receptor served at which the device may be installed. When a backflow prevention device does not bear a critical level marking, the bottom of the vacuum breaker, combination valve, or the bottom of any such approved device shall constitute the critical level.

**Cross-Connection** – Any connection or arrangement, physical or otherwise, between a potable water supply system and any plumbing fixture or any tank, receptor, equipment, or device, through which it may be possible for non-potable, used, unclear, polluted and contaminated water, or other substances to enter into any part of such potable water system under any condition.

#### 206.0 – D –

**Department Having Jurisdiction** – The Authority Having Jurisdiction, including any other law enforcement agency affected by any provision of this code, whether such agency is specifically named or not.

**Design Flood Elevation** – See TIA on page vi.

**Developed Length** – The length along the center line of a pipe and fittings.

**Dialysis Water System** – See TIA on page vi.

**Diameter** – Unless specifically stated, “diameter” is the nominal diameter as designated commercially.

**Domestic Sewage** – The liquid and water-borne wastes derived from the ordinary living processes, free from industrial wastes, and of such character as to permit satisfactory disposal, without special treatment, into the public sewer or by means of a private sewage disposal system.

**Downspout** – The rainleader from the roof to the building storm drain, combined building sewer, or other means of disposal located outside of the building. See Conductor and Leader.

**Drain** – Any pipe which carries waste or water-borne wastes in a building drainage system.

**Drainage System** – Includes all the piping within public or private premises which conveys sewage or other liquid wastes to a legal point of disposal, but does not include the mains of a public sewer system or a public sewage treatment or disposal plant.

**Durham System** – A soil or waste system in which all piping is threaded pipe, tubing, or other such rigid construction, using recessed drainage fittings to correspond to the types of piping.

#### 207.0 – E –

**Effective Opening** – The minimum cross-sectional area at the point of water supply discharge measured

or expressed in terms of (1) diameter of a circle or (2) if the opening is not circular, the diameter of a circle of equivalent cross-sectional area. (This is applicable also to airgap.)

**Essentially Nontoxic Transfer Fluid** - Essentially nontoxic at practically nontoxic, Toxicity Rating Class 1 (reference "Clinical Toxicology of Commercial Products" by Gosselin, Smith, Hodge, & Braddock).

**Existing Work** – A plumbing system or any part thereof which has been installed prior to the effective date of this code.

#### 208.0 – F –

**Fixture Branch** – A water supply pipe between the fixture supply pipe and the water distributing pipe.

**Fixture Drain** – The drain from the trap of a fixture to the junction of that drain with any other drain pipe.

**Fixture Supply** – A water supply pipe connecting the fixture with the fixture branch.

**Fixture Unit** – A quantity in terms of which the load-producing effects on the plumbing system of different kinds of plumbing fixtures are expressed on some arbitrarily chosen scale.

**Flammable Vapor or Fumes** is the concentration of flammable constituents in air that exceeds 25 percent of its lower flammability limit (LFL).

**Flood Hazard Area** – See TIA on page vi.

**Flood Hazard Area Subject to High Velocity Wave Action** – See TIA on page vi.

**Flood Level** – See Flooded.

**Flood-Level Rim** – The top edge of a receptor from which water overflows.

**Flooded** – A fixture is flooded when the liquid therein rises to the flood level rim.

**Flush Tank** – A tank located above or integral with water closets, urinals, or similar fixtures for the purpose of flushing the usable portion of the fixture.

**Flush Valve** – A valve located at the bottom of a tank for the purpose of flushing water closets and similar fixtures.

**Flushometer Tank** – A tank integrated within an air accumulator vessel which is designed to discharge a predetermined quantity of water to fixtures for flushing purposes.

**Flushometer Valve** – A valve which discharges a predetermined quantity of water to fixtures for flushing purposes and is actuated by direct water pressure.

#### 209.0 – G –

**Gang or Group Shower** – Two or more showers in a common area.

**Grade** – The slope or fall of a line of pipe in reference to a horizontal plane. In drainage, it is usually

expressed as the fall in a fraction of an inch (mm) or percentage slope per foot (meter) length of pipe.

**Grease Interceptor** – An interceptor of at least 750 gallon (2839 L) capacity to serve one (1) or more fixtures and which shall be remotely located.

**Grease Trap** – A device designed to retain grease from one (1) to a maximum of four (4) fixtures.

## 210.0 – H –

**Hangers** – See Supports.

**High Hazard** – See Contamination.

**Horizontal Branch** – A drain pipe extending laterally from a soil or waste stack or building drain with or without vertical sections or branches, which receives the discharge from one or more fixture drains and conducts it to the soil or waste stack or to the building drain.

**Horizontal Pipe** – Any pipe or fitting which is installed in a horizontal position or which makes an angle of less than forty-five (45) degrees with the horizontal.

**House Drain** – See Building Drain.

**House Sewer** – See Building Sewer.

## 211.0 – I –

**Indirect Waste Pipe** – A pipe that does not connect directly with the drainage system but conveys liquid wastes by discharging into a plumbing fixture, interceptor, or receptacle which is directly connected to the drainage system.

**Individual Vent** – A pipe installed to vent a fixture trap and which connects with the vent system above the fixture served or terminates in the open air.

**Industrial Waste** – Any and all liquid or water-borne waste from industrial or commercial processes, except domestic sewage.

**Insanitary** – A condition which is contrary to sanitary principles or is injurious to health.

Conditions to which “insanitary” shall apply include the following:

- (1) Any trap which does not maintain a proper trap seal.
- (2) Any opening in a drainage system, except where lawful, which is not provided with an approved water-sealed trap.
- (3) Any plumbing fixture or other waste-discharging receptor or device, which is not supplied with water sufficient to flush and maintain the fixture or receptor in a clean condition.

- (4) Any defective fixture, trap, pipe, or fitting.
- (5) Any trap, except where in this code exempted, directly connected to a drainage system, the seal of which is not protected against siphonage and back-pressure by a vent pipe.
- (6) Any connection, cross-connection, construction, or condition, temporary or permanent, which would permit or make possible by any means whatsoever, for any unapproved foreign matter to enter a water distribution system used for domestic purposes.
- (7) The foregoing enumeration of conditions to which the term “insanitary” shall apply shall not preclude the application of that term to conditions that are, in fact, insanitary.

**Interceptor (Clarifier)** – A device designed and installed so as to separate and retain deleterious, hazardous, or undesirable matter from normal wastes and permit normal sewage or liquid wastes to discharge into the disposal terminal by gravity.

**Invert** – The lowest portion of the inside of a horizontal pipe.

## 212.0 – J –

**Joint, Brazed** – Any joint obtained by joining of metal parts with alloys which melt at temperatures higher than 840°F (449°C), but lower than the melting temperature of the parts to be joined.

**Joint, Soldered** – A joint obtained by the joining of metal parts with metallic mixtures or alloys which melt at a temperature up to and including 840°F (449°C).

## 213.0 – K –

No definitions

## 214.0 – L –

**Labeled** – Equipment or materials bearing a label of a listing agency (accredited conformity assessment body). See Listed (third party certified).

**Lavatories in Sets** – Two (2) or three (3) lavatories that are served by one (1) trap.

**Leader** – An exterior vertical drainage pipe for conveying storm water from roof or gutter drains. See Downspout.

**Liquid Waste** – The discharge from any fixture, appliance, or appurtenance in connection with a plumbing system which does not receive fecal matter.

**Listed (Third party certified)** – Equipment or materials included in a list published by a listing agency (accredited conformity assessment body) that maintains periodic inspection on current production of listed equipment or materials and whose listing states either that the equipment or material complies with approved standards or has been tested and found suitable for use in a specified manner.

**Listing Agency** – An agency accredited by an independent and authoritative conformity assessment body to operate a material and product listing and labeling (certification) system and which is accepted by the Authority Having Jurisdiction which is in the business of listing or labeling. The system includes initial and ongoing product testing, a periodic inspection on current production of listed (certified) products, and which makes available a published report of such listing in which specific information is included that the material or product conforms to applicable standards and found safe for use in a specific manner.

**Lot** – A single or individual parcel or area of land legally recorded or validated by other means acceptable to the Authority Having Jurisdiction on which is situated a building or which is the site of any work regulated by this code, together with the yards, courts, and unoccupied spaces legally required for the building or works, and which is owned by or is in the lawful possession of the owner of the building or works.

**Low Hazard** – See Pollution.

## 215.0 – M –

**Macerating Toilet System** – A system comprising of a sump with macerating pump and with connections for a water closet and other plumbing fixtures, which is designed to accept, grind, and pump wastes to an approved point of discharge.

**Main** – The principal artery of any system of continuous piping to which branches may be connected.

**Main Sewer** – See Public Sewer.

**Main Vent** – The principal artery of the venting system to which vent branches may be connected.

**May** – A permissive term.

**Mobile Home Park Sewer** – That part of the horizontal piping of a drainage system which begins two (2) feet (610 mm) downstream from the last mobile home site and conveys it to a public sewer, private sewer, private sewage disposal system, or other point of disposal.

## 216.0 – N –

**Nuisance** – Includes, but is not limited to:

- (1) Any public nuisance known at common law or in equity jurisprudence.
- (2) Whenever any work regulated by this code is dangerous to human life or is detrimental to health and property.
- (3) Inadequate or unsafe water supply or sewage disposal system.

## 217.0 – O –

**Offset** – A combination of elbows or bends in a line of piping which brings one section of the pipe out of line but into a line parallel with the other section.

**Oil Interceptor** – See Interceptor.

## 218.0 – P –

**PB** – Polybutylene.

**PE** – Polyethylene.

**PE-AL-PE** – Polyethylene-aluminum-polyethylene.

**PEX** – Cross-linked polyethylene.

**PEX-AL-PEX** – Cross-linked polyethylene—aluminum-cross-linked polyethylene.

**Person** – A natural person, his heirs, executor, administrators, or assigns and shall also include a firm, corporation, municipal or quasi-municipal corporation, or governmental agency. Singular includes plural, male includes female.

**Pipe** – A cylindrical conduit or conductor conforming to the particular dimensions commonly known as “pipe size.”

**Plumbing** – The business, trade, or work having to do with the installation, removal, alteration, or repair of plumbing systems or parts thereof.

**Plumbing Appliance** – Any one of a special class of devices or equipment which is intended to perform a special plumbing function. Its operation and/or control may be dependent upon one or more energized components, such as motors, controls, heating elements, or pressure- or temperature-sensing elements. Such device or equipment may operate automatically through one or more of the following actions: a time cycle, a temperature range, a pressure range, a measured volume or weight; or the device or equipment may be manually adjusted or controlled by the user or operator.

**Plumbing Appurtenance** – A manufactured device, a prefabricated assembly, or an on-the-job assembly of component parts, which is an adjunct to the basic piping system and plumbing fixtures. An appurtenance demands no additional water supply,

nor does it add any discharge load to a fixture or the drainage system. It performs some useful function in the operation, maintenance, servicing, economy, or safety of the plumbing system.

**Plumbing Fixture** – An approved-type installed receptacle, device, or appliance which is supplied with water or which receives liquid or liquid-borne wastes and discharges such wastes into the drainage system to which it may be directly or indirectly connected. Industrial or commercial tanks, vats, and similar processing equipment are not plumbing fixtures, but may be connected to or discharged into approved traps or plumbing fixtures when and as otherwise provided for elsewhere in this code.

**Plumbing Official** – See Authority Having Jurisdiction.

**Plumbing System** – Includes all potable water, building supply, and distribution pipes, all plumbing fixtures and traps, all drainage and vent pipes, and all building drains and building sewers, including their respective joints and connections, devices, receptors, and appurtenances within the property lines of the premises and shall include potable water piping, potable water treating or using equipment, medical gas and medical vacuum systems, liquid and fuel gas piping, and water heaters and vents for same.

**Pollution** – An impairment of the quality of the potable water to a degree which does not create a hazard to the public health but which does adversely and unreasonably affect the aesthetic qualities of such potable water for domestic use. Also defined as Low Hazard.

**Potable Water** – Water that is satisfactory for drinking, culinary, and domestic purposes and that meets the requirements of the Health Authority Having Jurisdiction.

**PP** – Polypropylene.

**Pressure** – The normal force exerted by a homogeneous liquid or gas, per unit of area, on the wall of the container.

(1) Static Pressure – The pressure existing without any flow.

(2) Residual Pressure – The pressure available at the fixture or water outlet after allowance is made for pressure drop due to friction loss, head, meter, and other losses in the system during maximum demand periods.

**Pressure Balancing Valve** – A mixing valve which senses incoming hot and cold water pressures and compensates for fluctuations in either to stabilize outlet temperature.

**Private or Private Use** – Applies to plumbing

fixtures in residences and apartments, to private bathrooms in hotels and hospitals, and to restrooms in commercial establishments where the fixtures are intended for the use of a family or an individual.

**Private Sewage Disposal System** – A septic tank with the effluent discharging into a subsurface disposal field, into one or more seepage pits, or into a combination of subsurface disposal field and seepage pit or of such other facilities as may be permitted under the procedures set forth elsewhere in this code.

**Private Sewer** – A building sewer which receives the discharge from more than one (1) building drain and conveys it to a public sewer, private sewage disposal system, or other point of disposal.

**Public or Public Use** – All buildings or structures that are not defined as private or private use.

**Public Sewer** – A common sewer directly controlled by public authority.

**PVC** – Poly(vinyl chloride).

## 219.0 – Q –

No definitions.

## 220.0 – R –

**Receptor** – An approved plumbing fixture or device of such material, shape, and capacity as to adequately receive the discharge from indirect waste pipes, so constructed and located as to be readily cleaned.

**Regulating Equipment** – Includes all valves and controls used in a plumbing system which are required to be accessible or readily accessible.

**Relief Vent** – A vent, the primary function of which is to provide circulation of air between drainage and vent systems or to act as an auxiliary vent on a specially designed system.

**Remote Outlet** – When used for sizing water piping, it is the furthest outlet dimension, measuring from the meter, either the developed length of the cold-water piping or through the water heater to the furthest outlet on the hot-water piping.

**Rim** – See Flood-Level Rim.

**Riser** – A water supply pipe which extends vertically one (1) full story or more to convey water to branches or fixtures.

**Roof Drain** – A drain installed to receive water collecting on the surface of a roof and to discharge it into a leader, downspout, or conductor.

**Roughing-In** – The installation of all parts of the plumbing system which can be completed prior to the installation of fixtures. This includes drainage,

water supply, gas piping, and vent piping and the necessary fixture supports.

### 221.0 – S –

**Sand Interceptor** – See Interceptor.

**SDR** – An abbreviation for “standard dimensional ratio,” which is the specific ratio of the average specified outside diameter to the minimum wall thickness for outside controlled diameter plastic pipe.

**Seepage Pit** – A lined excavation in the ground which receives the discharge of a septic tank so designed as to permit the effluent from the septic tank to seep through its bottom and sides.

**Septic Tank** – A watertight receptacle which receives the discharge of a drainage system or part thereof, designed and constructed so as to retain solids, digest organic matter through a period of detention, and allow the liquids to discharge into the soil outside of the tank through a system of open joint piping or a seepage pit meeting the requirements of this code.

**Sewage** – Any liquid waste containing animal or vegetable matter in suspension or solution and that may include liquids containing chemicals in solution.

**Sewage Ejector** – A device for lifting sewage by entraining it on a high-velocity jet stream, air, or water.

**Sewage Pump** – A permanently installed mechanical device, other than an ejector, for removing sewage or liquid waste from a sump.

**Shall** – Indicates a mandatory requirement.

**Shielded Coupling** – An approved elastomeric sealing gasket with an approved outer shield and a tightening mechanism.

**Shock Arrestor** – See Water Hammer Arrestor.

**Should** – Indicates a recommendation or that which is advised but not required.

**Single Family Dwelling** – A building designed to be used as a home by the owner of such building, which shall be the only dwelling located on a parcel of ground with the usual accessory buildings.

**Size and Type of Tubing** – See Diameter.

**Slip Joint** – An adjustable tubing connection, consisting of a compression nut, a friction ring, and a compression washer, designed to fit a threaded adapter fitting, or a standard taper pipe thread.

**Slope** – See Grade.

**Soil Pipe** – Any pipe which conveys the discharge of water closets, urinals, clinic sinks, or fixtures having similar functions of collection and removal

of domestic sewage, with or without the discharge from other fixtures, to the building drain or building sewer.

**Special Wastes** – Wastes which require some special method of handling, such as the use of indirect waste piping and receptors, corrosion resistant piping, sand, oil or grease interceptors, condensers, or other pretreatment facilities.

**Stack** – The vertical main of a system of soil, waste, or vent piping extending through one or more stories.

**Stack Vent** – The extension of a soil or waste stack above the highest horizontal drain connected to the stack.

**Standard** – A document, the main text of which contains only mandatory provisions using the word “shall” to indicate requirements and which is in a form generally suitable for mandatory reference by another standard or code or for adoption into law. Nonmandatory provisions shall be located in an appendix, footnote, or fine-print note and are not to be considered a part of the requirements of a standard.

**Storm Drain** – See Building Drain (Storm).

**Storm Sewer** – A sewer used for conveying rainwater, surface water, condensate, cooling water, or similar liquid wastes.

**Subsoil Drain** – A drain which collects subsurface or seepage water and conveys it to a place of disposal.

**Sump** – An approved tank or pit which receives sewage or liquid waste and which is located below the normal grade of the gravity system and which must be emptied by mechanical means.

**Supports** – Supports, hangers, and anchors are devices for properly supporting and securing pipe, fixtures, and equipment.

### 222.0 – T –

**Tailpiece** – The pipe or tubing that connects the outlet of a plumbing fixture to a trap.

**Thermostatic (Temperature Control) Valve** – A mixing valve which senses outlet temperature and compensates for fluctuations in incoming hot or cold water temperatures.

**Trap** – A fitting or device so designed and constructed as to provide, when properly vented, a liquid seal which will prevent the back passage of air without materially affecting the flow of sewage or waste water through it.

**Trap Arm** – That portion of a fixture drain between a trap and the vent.



**Trap Primer** – A device and system of piping that maintains a water seal in a remote trap.

**Trap Seal** – The vertical distance between the crown weir and the top dip of the trap.

**Crown Weir (Trap Weir)** – The lowest point in the cross section of the horizontal waterway at the exit of the trap.

**Top Dip (of trap)** – The highest point in the internal cross section of the trap at the lowest part of the bend (inverted siphon). By contrast, the bottom dip is the lowest point in the internal cross section.

### 223.0 – U –

**Unconfined Space** – A room or space having a volume equal to at least 50 cubic feet per 1000 Btu/h (1.4 m<sup>3</sup>/293 W) of the aggregate input rating of all fuel-burning appliances installed in that space. Rooms communicating directly with the space in which the appliances are installed, through openings not furnished with doors, are considered a part of the unconfined space.

**Unsanitary** – See Insanitary.

### 224.0 – V –

**Vacuum** – Any pressure less than that exerted by the atmosphere.

**Vacuum Breaker** – See Backflow Preventer.

**Vacuum Relief Valve** – A device that prevents excessive vacuum in a pressure vessel.

**Vent** – Any pipe provided to ventilate a plumbing system, to prevent trap siphonage and back pressure, or to equalize the air pressure within the drainage system.

**Vent Pipe** – See Vent.

**Vent Stack** – The vertical vent pipe installed primarily for the purpose of providing circulation of air to and from any part of the drainage system.

**Vent System** – A pipe or pipes installed to provide a flow of air to or from a drainage system or to provide a circulation of air within such system to protect trap seals from siphonage and back-pressure.

**Vertical Pipe** – Any pipe or fitting which is installed in a vertical position or which makes an angle of not more than forty-five (45) degrees with the vertical.

### 225.0 – W –

**Wall-Hung Water Closet** – A water closet installed in such a way that no part of the water closet touches the floor.

**Waste** – See Liquid Waste and Industrial Waste.

**Waste Pipe** – A pipe which conveys only liquid waste, free of fecal matter.

**Water Conditioning or Treating Device** – A device which conditions or treats a water supply so as to change its chemical content or remove suspended solids by filtration.

**Water-Distributing Pipe** – In a building or premises, a pipe which conveys potable water from the building supply pipe to the plumbing fixtures and other water outlets.

**Water Hammer Arrestor** – A device to absorb hydraulic shock, either of the air chamber or mechanical device design.

**Water Main (Street Main)** – A water supply pipe for public or community use.

**Water Supply System** – The building supply pipe, the water distributing pipes and the necessary connecting pipes, fittings, control valves, backflow prevention devices, and all appurtenances carrying or supplying potable water in or adjacent to the building or premises.

**Welded Joint or Seam** – Any joint or seam obtained by the joining of metal parts in the plastic molten state.

**Welder, Pipe** – A person who specializes in the welding of pipes and holds a valid certificate of competency from a recognized testing laboratory, based on the requirements of the ASME Boiler and Pressure Vessels code, Section IX.

**Wet Vent** – A vent which also serves as a drain.

**Whirlpool Bathtub** – A bathtub fixture equipped and fitted with a circulating piping system designed to accept, circulate, and discharge bathtub water upon each use.

### 226.0 – X –

No definitions.

### 227.0 – Y –

**Yoke Vent** – A pipe connecting upward from a soil or waste stack to a vent stack for the purpose of preventing pressure changes in the stacks.

### 228.0 – Z –

No definitions.

# CHAPTER 3

## GENERAL REGULATIONS

### 301.0 Materials – Standards and Alternates.

#### 301.1 Minimum Standards.

**301.1.1 Approvals.** All pipe, pipe fittings, traps, fixtures, material, and devices used in a plumbing system shall be listed or labeled (third-party certified) by a listing agency (accredited conformity assessment body) and shall conform to approved applicable recognized standards referenced in this code, and shall be free from defects. Unless otherwise provided for in this code, all materials, fixtures, or devices used or entering into the construction of plumbing systems, or parts thereof, shall be submitted to the Authority Having Jurisdiction for approval.

**301.1.2 Marking.** Each length of pipe and each pipe fitting, trap, fixture, material, and device used in a plumbing system shall have cast, stamped, or indelibly marked on it the manufacturer's mark or name which shall readily identify the manufacturer to the end user of the product when such marking is required by the approved standard that applies. When required by the approved standard that applies the product shall be marked with the weight and the quality of the product. All materials and devices used or entering into the construction of plumbing and drainage systems, or parts thereof, shall be marked and identified in a manner satisfactory to the Authority Having Jurisdiction. All such marking shall be done by the manufacturer. Field marking shall not be acceptable.

**301.1.3 Standards.** Standards listed or referred to in this chapter or other chapters cover materials which will conform to the requirements of this code, when used in accordance with the limitations imposed in this or other chapters thereof and their listing. Where a standard covers materials of various grades, weights, quality, or configurations, there may be only a portion of the listed standard which is applicable. Design and materials for special conditions or materials not provided for herein may be used only by special permission of the Authority Having Jurisdiction after the Authority Having Jurisdiction has been satisfied as to their adequacy. A list of accepted plumbing materials standards is included in Table 14-1. All IAPMO Installation Standards are included in Appendix I for the convenience of the users of this code. They are not considered as a part of this code unless formally adopted as such by the Authority Having Jurisdiction.

**301.1.4 Existing Buildings.** In existing buildings or premises in which plumbing installations are to be altered, repaired, or renovated, the Authority Having Jurisdiction has discretionary powers to permit deviation from the provisions of this code, provided that such a proposal to deviate is first submitted for proper determination in order that health and safety requirements, as they pertain to plumbing, shall be observed.

**301.2 Alternate Materials and Methods Equivalency.** Nothing in this code is intended to prevent the use of systems, methods, or devices of equivalent or superior quality, strength, fire resistance, effectiveness, durability, and safety over those prescribed by this code. Technical documentation shall be submitted to the Authority Having Jurisdiction to demonstrate equivalency. The system, method, or device shall be approved for the intended purpose by the Authority Having Jurisdiction.

**301.2.1 Intent.** The provisions of this code are not intended to prevent the use of any alternate material or method of construction provided any such alternate has been first approved and its use authorized by the Authority Having Jurisdiction.

However, the exercise of this discretionary approval by the Authority Having Jurisdiction shall have no effect beyond the jurisdictional boundaries of said Authority Having Jurisdiction. Any alternate material or method of construction so approved shall not be considered as conforming to the requirements and/or intent of this code for any purpose other than installation or use within the jurisdiction granting the exception.

**301.2.2 Compliance.** The Authority Having Jurisdiction may approve any such alternate provided that the Authority Having Jurisdiction finds that the proposed design is satisfactory and complies with the intent of this code and the material offered is for the purpose intended, at least the equivalent of that prescribed in this code, in quality, strength, effectiveness, durability, and safety or that the methods of installation proposed conform to other acceptable nationally recognized plumbing standards.

**301.2.3 Requirements.** The Authority Having Jurisdiction shall require that sufficient evidence or proof be submitted to

substantiate any claims that may be made regarding the sufficiency of any proposed material or type of construction.

**301.2.4 Testing.** When there is insufficient evidence to substantiate claims for alternates, the Authority Having Jurisdiction shall have the authority to require tests, as proof of equivalency compliance, to be made by an approved testing agency at the expense of the applicant.

**301.2.4.1** Tests shall be made in accordance with approved standards, but in the absence of such standards, the Authority Having Jurisdiction shall specify the test procedure.

**301.2.4.2** The Authority Having Jurisdiction may require tests to be made or repeated if, at any time, there is reason to believe that any material or device no longer conforms to the requirements on which its approval was based.

**301.3 Flood Hazard Resistance. (See TIA on page vi)**

**301.3.1 General. (See TIA on page vi)**

**301.3.2 Flood Hazard Areas Subject to High Velocity Wave Action. (See TIA on page vi)**

**302.0 Iron Pipe Size (IPS) Pipe.**

Iron, steel, brass, and copper pipe shall be standard weight iron pipe size (IPS) pipe.

**303.0 Disposal of Liquid Waste.**

It shall be unlawful for any person to cause, suffer, or permit the disposal of sewage, human excrement, or other liquid wastes, in any place or manner, except through and by means of an approved drainage system, installed and maintained in accordance with the provisions of this code.

**304.0 Connections to Plumbing System Required.**

All plumbing fixtures, drains, appurtenances, and appliances, used to receive or discharge liquid wastes or sewage, shall be connected properly to the drainage system of the building or premises, in accordance with the requirements of this code.

**305.0 Sewers Required.**

**305.1** Every building in which plumbing fixtures are installed shall have a connection to a public or private sewer except as provided in Section 305.2.

**305.2** When a public sewer is not available for use, drainage piping from buildings and premises shall be connected to an approved private sewage disposal system.

**305.3** In cities and/or counties where the installation of building sewers is under the

jurisdiction of a department other than the Authority Having Jurisdiction, the provisions of this code relating to building sewers need not apply.

**306.0 Damage to Drainage System or Public Sewer.**

**306.1** It shall be unlawful for any person to deposit, by any means whatsoever, into any plumbing fixture, floor drain, interceptor, sump, receptor, or device, which is connected to any drainage system, public sewer, private sewer, septic tank, or cesspool, any ashes; cinders; solids; rags; inflammable, poisonous, or explosive liquids or gases; oils; grease; or any other thing whatsoever which would, or could, cause damage to the drainage system or public sewer.

**306.2** Roofs, inner courts, vent shafts, light wells, or similar areas having rainwater drain, shall discharge to the outside of the building or to the gutter and shall not be connected to the sanitary drainage system unless first approved by the Authority Having Jurisdiction.

**307.0 Industrial Wastes.**

**307.1** Wastes detrimental to the public sewer system or detrimental to the functioning of the sewage treatment plant shall be treated and disposed of as found necessary and directed by the Authority Having Jurisdiction or other Authority Having Jurisdiction.

**307.2** Sewage or other waste from a plumbing system which may be deleterious to surface or subsurface waters, shall not be discharged into the ground or into any waterway unless it has first been rendered safe by some acceptable form of treatment as required by the Authority Having Jurisdiction.

**308.0 Location.**

**308.1** Except as otherwise provided in this code, no plumbing system, drainage system, building sewer, private sewage disposal system, or parts thereof shall be located in any lot other than the lot which is the site of the building, structure, or premises served by such facilities.

**308.2** No subdivision, sale, or transfer of ownership of existing property shall be made in such manner that the area, clearance, and access requirements of this code are decreased.

**309.0 Improper Location.**

Piping, fixtures, or equipment shall not be so located as to interfere with the normal use thereof or with the normal operation and use of windows, doors, or other required facilities.

**310.0 Workmanship.**

**310.1** All design, construction, and workmanship shall be in conformity with accepted engineering practices and shall be of such character as to secure the results sought to be obtained by this code.

**310.2** It is unlawful to conceal cracks, holes, or other imperfections in materials by welding, brazing, or soldering or by using therein or thereon any paint, wax, tar, or other leak-sealing or repair agent.

**310.3** Burred ends of all pipe and tubing shall be reamed to the full bore of the pipe or tube and all chips shall be removed.

**310.4 Installation Practices.** Plumbing systems shall be installed in a manner conforming to this code, applicable standards, and the manufacturer's installation instructions. In instances where the code, applicable standards, or the manufacturer's instructions conflict, the more stringent provisions shall prevail.

**311.0 Prohibited Fittings and Practices.**

**311.1** No double hub fitting, single or double tee branch, single or double tapped tee branch, side inlet quarter bend, running thread, band, or saddle shall be used as a drainage fitting, except that a double hub sanitary tapped tee may be used on a vertical line as a fixture connection.

**311.2** No drainage or vent piping shall be drilled and tapped for the purpose of making connections thereto, and no cast-iron soil pipe shall be threaded.

**311.3** No waste connection shall be made to a closet bend or stub of a water closet or similar fixture.

**311.4** Except as hereinafter provided in Sections 908.0, 909.0 and 910.0, no vent pipe shall be used as a soil or waste pipe, nor shall any soil or waste pipe be used as a vent. Also, single stack drainage and venting systems, with unvented branch lines are prohibited.

**311.5** No fitting, fixture and piping connection, appliance, device, or method of installation which obstructs or retards the flow of water, wastes, sewage, or air in the drainage or venting systems, in an amount greater than the normal frictional resistance to flow, shall be used unless it is indicated as acceptable in this code or is approved by the Authority Having Jurisdiction as having a desirable and acceptable function and of ultimate benefit to the proper and continuing functioning of the plumbing system. The enlargement of a three (3) inch (80 mm) closet bend or stub to four (4) inches (100 mm) shall not be considered an obstruction.

**311.6** Except for necessary valves, where intermembering or mixing of dissimilar metals occurs, the point of connection shall be confined to exposed or accessible locations.

**311.7** All valves, pipes, and fittings shall be installed in correct relationship to the direction of flow.

**311.8 Screwed Fittings.** Screwed fittings shall be ABS, cast iron, copper, copper alloy, malleable iron, PVC, steel, or other approved materials. Threads shall be tapped out of solid metal or molded in solid ABS or PVC.

**312.0 Independent Systems.**

The drainage system of each new building and of new work installed in any existing building shall be separate and independent from that of any other building and when available, every building shall have an independent connection with a public or private sewer.

**Exception:** Where one building stands in the rear of another building on an interior lot, and no private sewer is available or can be constructed to the rear building through an adjoining court, yard, or driveway, the building drain from the front building may be extended to the rear building.

**313.0 Protection of Piping, Materials, and Structures.**

**313.1** All piping passing under or through walls shall be protected from breakage. All piping passing through or under cinders or other corrosive materials shall be protected from external corrosion in an approved manner. Approved provisions shall be made for expansion of hot water piping. Voids around piping passing through concrete floors on the ground shall be appropriately sealed.

**313.2** All piping in connection with a plumbing system shall be so installed that piping or connections will not be subject to undue strains or stresses, and provisions shall be made for expansion, contraction, and structural settlement. No plumbing piping shall be directly embedded in concrete or masonry. No structural member shall be seriously weakened or impaired by cutting, notching, or otherwise, as defined in the Building Code.

**313.3** All trenches deeper than the footing of any building or structure and paralleling the same shall be at least forty-five (45) degrees (0.79 rad) therefrom, unless permission be otherwise granted by the Authority Having Jurisdiction.

**313.4** No building sewer or other drainage piping or part thereof, constructed of materials other than those approved for use under or within a building, shall be installed under or within two (2) feet (610 mm) of any building or structure, or less than one (1) foot (305 mm) below the surface of the ground.

**313.5** Piping subject to corrosion, erosion, or mechanical damage shall be protected in an approved manner.

**313.6** No water, soil, or waste pipe shall be installed or permitted outside of a building or in an exterior

wall unless, where necessary, adequate provision is made to protect such pipe from freezing.

**313.7** All piping penetrations of fire-resistance-rated walls, partitions, floors, floor/ceiling assemblies, roof/ceiling assemblies, or shaft enclosures shall be protected in accordance with the requirements of the Building Code, IAPMO Installation Standards, and Chapter 15, "Firestop Protection."

**313.8 Waterproofing of Openings.** Joints at the roof around pipes, ducts, or other appurtenances shall be made watertight by the use of lead, copper, galvanized iron, or other approved flashings or flashing material. Exterior wall openings shall be made watertight. Counterflashing shall not restrict the required internal cross-sectional area of the vent.

**313.9** Plastic and copper piping run through framing members to within one (1) inch (25.4 mm) of the exposed framing shall be protected by steel nail plates not less than 18 gauge.

**Exception:** See Section 1211.3.4.

**313.10 Sleeves.**

**313.10.1** Sleeves shall be provided to protect all piping through concrete and masonry walls.

**313.10.2** Piping through concrete or masonry walls shall not be subject to any load from building construction.

**313.10.3** In exterior walls, annular space between sleeves and pipes shall be sealed and made watertight as approved by the Authority Having Jurisdiction. Any penetration through fire-resistive construction shall be in accordance with Section 313.7.

**313.10.4** Any pipe sleeve through a firewall shall have the space around the pipe completely sealed with an approved fire-resistive material in accordance with all other codes.

**313.11** Any structural member weakened or impaired by cutting, notching, or otherwise shall be reinforced, repaired, or replaced so as to be left in a safe structural condition in accordance with the requirements of the Building Code or as required by the proper Authority Having Jurisdiction.

**313.12 Ratproofing.**

**313.12.1** Strainer plates on drain inlets shall be designed and installed so that no opening is greater than one-half (1/2) inch (12.7 mm) in the least dimension.

**313.12.2** Meter boxes shall be constructed in such a manner that rats cannot enter a building by following the service pipes from the box into the building.

**313.12.3** In or on buildings where openings have been made in walls, floors, or ceilings for

the passage of pipes, such openings shall be closed and protected by the installation of approved metal collars securely fastened to the adjoining structure.

**314.0 Hangers and Supports.**

**314.1** Suspended piping shall be supported at intervals not to exceed those shown in Table 3-2.

**314.2** All piping shall be supported in such a manner as to maintain its alignment and prevent sagging.

**314.3** Piping in the ground shall be laid on a firm bed for its entire length. Where support is otherwise provided, it shall be otherwise provided, it shall be acceptable to the Authority Having Jurisdiction.

**314.4** Hangers and anchors shall be of sufficient strength to support the weight of the pipe and its contents. Piping shall be isolated from incompatible materials.

**314.5** All piping, fixtures, appliances, and appurtenances shall be adequately supported in accordance with this code and the manufacturer's installation instructions and as approved by the Authority Having Jurisdiction.

**314.5.1** In seismic zones 3 and 4, hubless cast iron piping in sizes five (5) inches (125 mm) and larger suspended in exposed locations over public or high traffic areas, pipe over four (4) feet (1219 mm) in length shall be provided with support on both sides of the coupling.

**314.6** Hanger rod sizes shall be no smaller than those shown in Table 3-1.

**314.7** All gas piping shall be supported by metal straps or hooks at intervals not to exceed those shown in Table 3-2.

**TABLE 3-1  
Hanger Rod Sizes**

Pipe and Tube Size		Rod Size	
Inches	mm	Inches	mm
1/2 – 4	12.7 – 102	3/8	9.5
5 – 8	127 – 203	1/2	12.7
10 – 12	254 – 305	5/8	15.9

**315.0 Trenching, Excavation, and Backfill.**

**315.1** All trenches deeper than the footing of any building or structure and paralleling the same shall be at least forty-five (45) degrees (0.79 rad) therefrom, unless permission is otherwise granted by the Authority Having Jurisdiction.

**315.2** Tunneling and driving may be done in yards, courts, or driveways of any building site. Where sufficient depth is available to permit, tunnels may

be used between open-cut trenches. Tunnels shall have a clear height of two (2) feet (610 mm) above the pipe and shall be limited in length to one-half (1/2) the depth of the trench, with a maximum length of eight (8) feet (2438 mm). When pipes are driven, the drive pipe shall be at least one (1) size larger than the pipe to be laid.

**315.3 Open Trenches.** All excavations required to be made for the installation of a building drainage system or any part thereof, within the walls of a building, shall be open trench work and shall be kept open until the piping has been inspected, tested, and accepted.

**315.4** All excavations shall be completely backfilled as soon after inspection as practicable. Adequate precaution shall be taken to insure proper compactness of backfill around piping without damage to such piping. Trenches shall be backfilled in thin layers to twelve (12) inches (305 mm) above the top of the piping with clean earth, which shall not contain stones, boulders, cinderfill, frozen earth, construction debris, or other materials which would damage or break the piping or cause corrosive action. Mechanical devices such as bulldozers, graders, etc., may then be used to complete backfill to grade. Fill shall be properly compacted. Suitable precautions shall be taken to insure permanent stability for pipe laid in filled or made ground.

### 316.0 Joints and Connections.

#### 316.1 Types of Joints.

**316.1.1 Threaded Joints.** Threads on iron pipe size (IPS) pipe and fittings shall be standard taper pipe threads in accordance with standards listed in Table 14-1. Threads on tubing shall be approved types. Threads on plastic pipe shall be factory cut or molded. Threaded plastic pipe shall be Schedule 80 minimum wall thickness. Tubing threads shall conform to fine tubing thread standards. When a pipe joint material is used, it shall be applied only on male threads, and such materials shall be approved types, insoluble in water and nontoxic. Cleanout plugs and caps shall be lubricated with water-insoluble, non-hardening material or tape. Thread tape or thread lubricants and sealants specifically intended for use with plastics shall be used on plastic threads. Conventional pipe thread compounds, putty, linseed-oil-based products, and unknown lubricants and sealants shall not be used on plastic threads.

**316.1.2 Wiped Joints.** Joints in lead pipe or fittings or between lead pipe or fittings and brass or copper pipe, ferrules, solder nipples, or traps shall be full-wiped joints. Wiped joints shall

have an exposed surface on each side of a joint not less than three-fourths (3/4) inch (19.1 mm) and at least as thick as the material being joined. Wall or floor flange lead-wiped joints shall be made by using a lead ring or flange placed behind the joint at wall or floor. Joints between lead pipe and cast iron, steel, or wrought iron shall be made by means of a caulking ferrule or soldering nipple.

**316.1.3 Soldered Joints.** Joints in copper tubing shall be made by the appropriate use of approved copper or copper alloy fittings. Surfaces to be joined by soldering shall be cleaned bright by manual or mechanical means. The joints shall be properly fluxed with an approved type flux and made up with approved solder. All solder and fluxes shall be manufactured to approved standards. Solders and fluxes with a lead content which exceeds two-tenths (0.20) of one (1) percent shall be prohibited in piping systems used to convey potable water.

**316.1.4 Flared Joints.** Flared joints for soft copper tubing shall be made with fittings meeting approved standards. The tubing shall be reamed to the full inside diameter, resized to round, and expanded with a proper flaring tool.

**316.1.5 Flexible Compression Factory-Fabricated Joints.** When pipe is joined by means of flexible compression joints, such joints shall conform to approved standards and shall not be considered as slip joints.

**316.1.6 Solvent Cement Plastic Pipe Joints.** Plastic pipe and fittings designed to be joined by solvent cementing shall comply with appropriate IAPMO Installation Standards.

ABS pipe and fittings shall be cleaned and then joined with solvent cement(s).

CPVC pipe and fittings shall be cleaned and then joined with listed primer(s) and solvent cement(s).

**Exception:** Listed solvent cements that do not require the use of primer shall be permitted for use with CPVC pipe and fittings, manufactured in accordance with ASTM D2846, 1/2 inch through 2 inches in diameter.

PVC pipe and fittings shall be cleaned and joined with primer(s) and solvent cement(s).

**316.1.7 Brazing and Welding.** Brazing and welding shall conform to the applicable standard(s) in Table 14-1. All brazing on medical gas systems shall be performed by certified installers meeting the requirements of ANSI/ASME Boiler and Pressure Vessel Code, Section IX, Welding and Brazing Qualifications

or AWS B2.2, Standard for Brazing Procedure and Performance Qualifications.

**316.1.8 Pressure-Lock Type Connection.**

This is mechanical connection which depends on an internal retention device to prevent pipe or tubing separation. Connection is made by inserting the pipe or tubing into the fitting to a prescribed depth.

**316.1.9 Pressed Fitting.** This is a mechanical connection for joining copper tubing which uses a crimping tool to affix the O-ring seal copper or copper alloy fitting to the tubing. The tubing shall be inserted into the fitting, and the crimp shall be made using the tool recommended by the manufacturer.

**316.2 Special Joints.**

**316.2.1 Copper Tubing to Screw Pipe Joints.**

Joints from copper tubing to threaded pipe shall be made by the use of brass adapter fittings. The joint between the copper tubing and the fitting shall be properly soldered, and the connection between the threaded pipe and the fitting shall be made with a standard pipe size screw joint. Solder shall conform to the requirements of Section 316.1.3.

**316.2.2 Unions.** Approved unions may be used in drainage work when accessibly located in the trap seal or between a fixture and its trap in the vent system, except underground or in wet vents at any point in the water supply system, and in gas piping as permitted by Section 1211.3.2(4).

**316.2.3 Plastic Pipe to Other Materials.** When connecting plastic pipe to other types of piping, only approved types of fittings and adapters designed for the specific transition intended shall be used.

**316.3 Flanged Fixture Connections.**

**316.3.1** Fixture connections between drainage pipes and water closets and floor outlet service sinks and urinals shall be made by means of approved brass, hard lead, ABS, PVC, or iron flanges caulked, soldered, solvent cemented; rubber compression gaskets; or screwed to the drainage pipe. The connection shall be bolted with an approved gasket, washer, or setting compound between the fixture and the connection. The bottom of the flange shall be set on an approved firm base.

**316.3.2** Closet bends or stubs shall be cut off so as to present a smooth surface even with the top of the closet ring before rough inspection is called.

**316.3.3** Wall-mounted water closet fixtures shall be securely bolted to an approved carrier fitting. The connecting piping between the carrier fitting and the fixture shall be an approved material and designed to accommodate an adequately sized gasket. Gasket material shall be neoprene, felt, or similar approved types.

**316.4 Prohibited Joints and Connections.**

**316.4.1 Drainage System.** Any fitting or

connection which has an enlargement, chamber, or recess with a ledge, shoulder or reduction of pipe area that offers an obstruction to flow through the drain shall be prohibited.

**316.4.2** No fitting or connection that offers abnormal obstruction to flow shall be used. The enlargement of a three (3) inch (80 mm) closet bend or stub to four (4) inches (100 mm) shall not be considered an obstruction.

**317.0 Increases and Reducers.**

Where different sizes of pipes or pipes and fittings are to be connected, the proper size increasers or reducers or reducing fittings shall be used between the two sizes. Brass or cast-iron body cleanouts shall not be used as a reducer or adapter from cast-iron drainage pipe to iron pipe size (IPS) pipe.

**318.0 Food-Handling Establishments.**

Food or drink shall not be stored, prepared, or displayed beneath soil or drain pipes, unless those areas are protected against leakage or condensation from such pipes reaching the food or drink as described below. Where building design requires that soil or drain pipes be located over such areas, the installation shall be made with the least possible number of joints and shall be installed so as to connect to the nearest adequately sized vertical stack with the provisions as follows:

**318.1** All openings through floors over such areas shall be sealed watertight to the floor construction.

**318.2** Floor and shower drains installed above such areas shall be equipped with integral seepage pans.

**318.3** All other soil or drain pipes shall be of an approved material as listed in Table 14-1 and Section 701.0. All materials shall conform to established standards. Cleanouts shall be extended through the floor construction above.

**318.4** Soil and drain pipes located above such areas shall be subjected to a standing water test of not less than twenty-five (25) feet (7620 mm).

**318.5** Piping subject to operation at temperatures that will form condensation on the exterior of the pipe shall be thermally insulated.

**318.6** Where pipes are installed in ceilings above such areas, the ceiling shall be of the removable type, or shall be provided with access panels in order to form a ready access for inspection of piping.

**318.7** In lieu of the above, any other method may be approved by the Authority Having Jurisdiction.

**319.0 Test Gauges.** Tests required by this code, which are performed utilizing dial gauges, shall be

limited to gauges having the following pressure graduations or incrementations.

**319.1** Required pressure tests of ten (10) psi (69 kPa) or less shall be performed with gauges of 1/10 pound (0.7 kPa) incrementation or less.

**319.2** Required pressure tests exceeding ten (10) pounds (69 kPa) but less than one hundred (100) psi (689 kPa) shall be performed with gauges of one (1) psi (6.9 kPa) incrementation or less.

**319.3** Required pressure tests exceeding one hundred (100) psi (689 kPa) shall be performed with

gauges incremented for two (2) percent or less of the required test pressure.

**319.4** Test gauges shall have a pressure range not greater than twice the test pressure applied.

**320.0 Medical Gas and Vacuum Systems.** All such piping shall be installed, tested, and verified in compliance with the appropriate consensus standards referenced in Chapter 14 and the requirements of Chapter 13. The Authority Having Jurisdiction shall require evidence of the competency of the installers and verifiers.

**TABLE 3-2  
Hangers and Supports**

Materials	Types of Joints	Horizontal	Vertical
Cast	Lead and Oakum	5 feet (1524 mm), except may be 10 feet (3048 mm) where 10 foot lengths are installed <sup>1,2,3</sup>	Base and each floor not to exceed 15 feet (4572 mm)
	Compression Gasket	Every other joint, unless over 4 feet (1219 mm), then support each joint <sup>1,2,3</sup>	Base and each floor not to exceed 15 feet (4572 mm)
Cast-Iron Hubless	Shielded Coupling	Every other joint, unless over 4 feet (1219 mm), then support each joint <sup>1,2,3,4</sup>	Base and each floor not to exceed 15 feet (4572 mm)
Copper Tube and Pipe	Soldered or Brazed	1-1/2 inches (40 mm) and smaller, 6 feet (1829 mm), 2 inches (50 mm) and larger, 10 feet (3048 mm)	Each floor, not to exceed 10 feet (3048 mm) <sup>5</sup>
Steel and Brass Pipe for Water or DWV	Threaded or Welded	3/4 inch (20 mm) and smaller, 10 feet (3048 mm), 1 inch (25 mm) and larger, 12 feet (3658 mm)	Every other floor, not to exceed 25 feet (7620 mm) <sup>5</sup>
Steel, Brass, and Tinned Copper Pipe for Gas	Threaded or Welded	1/2 inch (15 mm), 6 feet (1829 mm), 3/4 inch (20 mm) and 1 inch (25.4 mm), 8 feet (2438 mm), 1-1/4 inch (32 mm) and larger, 10 feet (3048 mm)	1/2 inch (12.7 mm), 6 feet (1829 mm), 3/4 inch (19 mm) and 1 inch (25.4 mm), 8 feet (2438 mm), 1-1/4 every floor level
Schedule 40 PVC and ABS DWV	Solvent Cemented	All sizes, 4 feet (1219 mm). Allow for expansion every 30 feet (9144 mm) <sup>3,6</sup>	Base and each floor. Provide midstory guides. Provide for expansion every 30 feet (9144 mm) <sup>6</sup>
CPVC	Solvent Cemented	1 inch (25 mm) and smaller, 3 feet (914 mm), 1-1/4 inch (932 mm) and larger, 4 feet (1219 mm)	Base and each floor. Provide midstory guides <sup>6</sup>
Lead	Wiped or Burned	Continuous Support	Not to exceed 4 feet (1219 mm)
Copper	Mechanical	In accordance with standards acceptable to the Authority Having Jurisdiction	
Steel and Brass	Mechanical	In accordance with standards acceptable to the Authority Having Jurisdiction	
PEX	Metal Insert and Metal Compression	32 inches (800 mm)	Base and each floor. Provide midstory guides
PEX-AL-PEX	Metal Insert and Metal Compression	1/2 inch (12 mm) 3/4 inch (20 mm) 1 inch (25 mm)	All sizes 98 inches (2489 mm) Base and each floor. Provide midstory guides
PE-AL-PE	Metal Insert and Metal Compression	1/2 inch (12 mm) 3/4 inch (20 mm) 1 inch (25 mm)	

<sup>1</sup> Support adjacent to joint, not to exceed eighteen (18) inches (457 mm).

<sup>2</sup> Brace at not more than forty (40) foot (12,192 mm) intervals to prevent horizontal movement.

<sup>3</sup> Support at each horizontal branch connection.

<sup>4</sup> Hangers shall not be placed on the coupling.

<sup>5</sup> Vertical water lines may be supported in accordance with recognized engineering principles with regard to expansion and contraction, when first approved by the Authority Having Jurisdiction.

<sup>6</sup> See the appropriate IAPMO Installation Standard for expansion and other special requirements.





## CHAPTER 4

### PLUMBING FIXTURES AND FIXTURE FITTINGS

#### 401.0 Materials – General Requirements.

**401.1 Quality of Fixtures.** Plumbing fixtures shall be constructed of dense, durable, non-absorbent materials and shall have smooth, impervious surfaces, free from unnecessary concealed fouling surfaces. Except as permitted elsewhere in this code, all fixtures shall conform in quality and design to nationally recognized applicable standards or to other approved standards acceptable to the Authority Having Jurisdiction. A list of accepted plumbing fixture standards is included in Table 14-1.

**401.2 Lead.** See Table 14-1. Sheet lead shall be not less than the following:

For safe pans – not less than four (4) pounds per square foot (19.5 kg/m<sup>2</sup>) or 1/16 inch (1.6 mm) thick.

#### 402.0 Water-Conserving Fixtures and Fittings.

**402.1** Flush volumes for low consumption and water saver water closets and urinals shall be in accordance with applicable standards referenced in Table 14-1.

**402.2 Water Closets.** Water closets, either flush tank, flushometer tank, or flushometer valve operated, shall have an average consumption of not more than 1.6 gallons (6.1 liters) of water per flush.

**402.3 Urinals.** Urinals shall have an average water consumption of not more than 1.0 gallon (3.8 liters) of water per flush.

**Exception:** If approved by the Authority Having Jurisdiction, blowout urinals may be installed for public use in stadiums, race courses, fairgrounds, and other structures used for outdoor assembly and for similar uses.

**402.4 Metered Faucets.** Self-closing or self-closing metering faucets shall be installed on lavatories intended to serve the transient public, such as those in, but not limited to, service stations, train stations, airports, restaurants, and convention halls. Metered faucets shall deliver not more than 0.25 gallons (1.0 liter) of water per use.

**402.5 Emergency Safety Showers.** Emergency safety showers shall not be limited in their water supply flow rates.

**402.6 Installation.** Water-conserving fixtures shall be installed in strict accordance with the manufacturers' instructions to maintain their rated performance.

#### 403.0 Materials – Alternates.

Special use fixtures shall be made of one of the following:

- (A) Soapstone
- (B) Chemical stoneware
- (C) Copper-based alloy
- (D) Nickel-based alloy
- (E) Corrosion-resistant steel
- (F) Other materials lined with lead
- (G) Other materials suited for the intended use of the fixture.

**403.1 Zinc Alloy Components.** Zinc alloy components shall meet the applicable nationally recognized standards and shall be used in accordance with their listing.

#### 404.0 Overflows.

When any fixture is provided with an overflow, the waste shall be so arranged that the standing water in the fixture cannot rise in the overflow when the stopper is closed or remain in the overflow when the fixture is empty. The overflow pipe from a fixture shall be connected on the house or inlet side of the fixture trap, except that overflow on flush tanks may discharge into the water closets or urinals served by them, but it shall be unlawful to connect such overflows with any other part of the drainage system.

#### 405.0 Strainers and Connections.

**405.1 Strainers.** All plumbing fixtures, other than water closets and urinals, shall be equipped with approved strainers having an approved waterway area. Strainers serving shower drains shall have a waterway equivalent to the area of the tailpiece.

**405.2 Connections.** Fixtures having concealed slip joint connections shall be provided with an access panel or utility space at least twelve (12) inches (305 mm) in its least dimension and so arranged without obstructions as to make such connections accessible for inspection and repair.

**405.3** Continuous wastes and fixture tailpieces shall be constructed from the materials specified in Section 701.0 for drainage piping, provided, however, that such connections where exposed or accessible may be of seamless drawn brass not less than No. 20 B&S Gauge (0.032 inches) (0.8 mm). Each such tailpiece, continuous waste,

or waste and overflow shall not be less than one and one-half (1-1/2) inches (40 mm) O.D. for sinks, dishwashers, laundry tubs, bathtubs, urinals, and similar fixtures, and not less than one and one-quarter (1-1/4) inches (32 mm) for lavatories, drinking fountains, and similar small fixtures.

**405.4** Approved wye or other directional type branch fittings shall be installed in all continuous wastes connecting or receiving the discharge from food waste disposal units, dishwashers, clothes washers, or other force discharge fixtures or appliances. No dishwasher drain shall be connected to a sink tailpiece, continuous waste or trap on the discharge side of a food waste disposal unit.

#### **406.0 Prohibited Fixtures.**

**406.1** Water closets having an invisible seal or an unventilated space or having walls which are not thoroughly washed at each discharge shall be prohibited. Any water closet which might permit siphonage of the contents of the bowl back into the tank shall be prohibited. Drinking fountains shall not be installed in public toilet rooms.

**406.2 Prohibited Urinals.** Floor-type and wall-hung-type trough urinals shall be prohibited. Urinals which have an invisible seal or which have an unventilated space or wall which is not thoroughly washed at each discharge shall be prohibited.

**406.3** Fixed wooden, concrete, cement, or tile wash trays or sinks for domestic use shall not be installed in any building designed or used for human habitation. No sheet-metal-lined wooden bathtub shall be installed or reconnected. No dry or chemical closet (toilet) shall be installed in any building used for human habitation, unless first approved by the Health Officer.

**406.4 Concealed Fouling Surfaces.** Fixtures shall be so designed that they are free from concealed fouling surfaces.

#### **407.0 Special Fixtures and Specialties.**

**407.1 Water Connections.** Baptisteries, ornamental and lily ponds, aquaria, ornamental fountain basins, and similar constructions when provided with water supplies shall be protected from back-siphonage.

**407.2** Restaurant kitchen and other special use sinks may be made of approved type bonderized and galvanized sheet steel of not less than No. 16 U.S. Gauge (0.0625 inches) (1.6 mm). All sheet-metal plumbing fixtures shall be adequately designed, constructed, and braced in an approved manner to satisfactorily accomplish their intended purpose.

**407.3 Approved.** Specialties requiring water and waste connections shall be submitted for approval of the Authority Having Jurisdiction.

#### **408.0 Installation.**

**408.1 Cleaning.** Plumbing fixtures shall be installed in a manner to afford easy access for repairs and cleaning. Where practical, all pipes from fixtures shall be run to the nearest wall.

**408.2 Joints.** Where a fixture comes in contact with the wall or floor, the joint between the fixture and the wall or floor shall be made watertight.

**408.3 Securing Fixtures.** Floor-outlet or floor-mounted fixtures shall be rigidly secured to the drainage connection and to the floor when so designed, by screws or bolts of copper, brass, or other equally corrosion-resistant material.

**408.4 Wall-Hung Fixtures.** Wall-hung fixtures shall be rigidly supported by metal supporting members so that no strain is transmitted to the connections. Flush tanks and similar appurtenances shall be secured by approved non-corrosive screws or bolts.

**408.5 Securing Floor-Mounted, Back-Outlet Water Closet Bowls.** Floor-mounted, back-outlet water closet bowls shall be set level with an angle of ninety (90) degrees (1.58 rad) between the floor and wall at the centerline of the fixture outlet. The floor and wall shall have a flat mounting surface for at least five (5) inches (127 mm) to the right and left of the fixture outlet centerline. The fixture shall be secured to the wall outlet flange or drainage connection and to the floor by corrosion-resistant screws or bolts. The closet flange shall be secured to a firm base.

Where floor-mounted, back-outlet water closets are used, the soil pipe shall not be less than three (3) inches (80 mm) in diameter. Offset, eccentric, or reducing floor flanges shall not be used.

**408.6 Setting.** Fixtures shall be set level and in proper alignment with reference to adjacent walls. No water closet or bidet shall be set closer than fifteen (15) inches (381 mm) from its center to any side wall or obstruction nor closer than thirty (30) inches (762 mm) center to center to any similar fixture. The clear space in front of any water closet or bidet shall not be less than twenty-four (24) inches (610 mm). No urinal shall be set closer than twelve (12) inches (305 mm) from its center to any side wall or partition nor closer than twenty-four (24) inches (610 mm) center to center.

**408.7 Installations for the Handicapped.** Where facilities for the handicapped are required in applicable building regulations, the facilities shall be installed in accordance with those regulations.

**408.8 Supply Fittings.** The supply lines or fittings for every plumbing fixture shall be so installed as to prevent backflow as required in Chapter 6.

#### **409.0 Water Closets.**

**409.1** Water closet bowls for public use shall be of the elongated type. In nurseries, schools, and other similar places where plumbing fixtures are provided for the use of children under six (6) years of age, water closets shall be of a size and height suitable for children's use. All water closets shall be equipped with seats as required below.

#### **409.2 Water Closet Seats.**

**409.2.1** Water closet seats shall be of smooth non-absorbent material.

**409.2.2** All water closet seats, except those within dwelling units, shall be of the open front type.

**409.2.3** Water closet seats shall be properly sized for the water closet bowl type.

**409.2.4** Seats for use in public buildings shall conform to the standard listed in Table 14-1.

#### **410.0 Urinals.**

Every water supply to a urinal shall be protected by an approved type vacuum breaker or other approved backflow prevention device as described in Section 603.3.

#### **411.0 Flushing Devices for Water Closets and Urinals.**

**411.1 Flushing Devices Required.** Each water closet, urinal, clinic sink, or other plumbing fixture which depends on trap siphonage to discharge its waste contents shall be provided with a flushometer valve, flushometer tank, or flush tank designed and installed so as to supply water in sufficient quantity and rate of flow to flush the contents of the fixture to which it is connected, to cleanse the fixture, and to refill the fixture trap, without excessive water use. Flushing devices shall meet anti-siphon requirements required in Chapter 6.

**411.2 Automatic Flushing Tanks.** Tanks flushing more than one (1) urinal shall be automatic in operation and of sufficient capacity to provide the necessary volume to flush and properly cleanse all urinals simultaneously. Automatically controlled flushometer valves may be substituted for flush tanks.

**411.3 Flushometer Valves.** No manually controlled flushometer valve shall be used to flush more than one (1) urinal, and each such urinal flushometer valve shall be an approved, self-closing

type discharging a predetermined quantity of water. Flushometers shall be installed so that they will be accessible for repair. Flushometer valves shall not be used where the water pressure is insufficient to properly operate them. When the valve is operated, it shall complete the cycle of operation automatically, opening fully and closing positively under the line water pressure. Each flushometer shall be provided with a means for regulating the flow through it.

**411.4 Water Supply for Flush Tanks.** An adequate quantity of water shall be provided to flush and clean the fixture served. The water supply for flushing tanks and flushometer tanks equipped for manual flushing shall be controlled by a float valve or other automatic device designed to refill the tank after each discharge and to completely shut off the water flow to the tank when the tank is filled to operational capacity. Provision shall be made to automatically supply water to the fixture so as to refill the trap seal after each flushing. The water supply to flush tanks equipped for automatic flushing shall be controlled by a suitable timing device.

**411.5 Flush Valves in Flush Tanks.** Flush valve seats in tanks for flushing water closets shall be at least one (1) inch (25.4 mm) above the flood level rim of the bowl connected thereto, except in approved water closet and flush tank combinations designed so that when the tank is flushed and the fixture is clogged or partially clogged, the flush valve closes tightly so that water does not spill continuously over the rim of the bowl or backflow from the bowl to the tank.

**411.6 Overflows in Flush Tanks.** Flush tanks shall be provided with overflows discharging into the water closet or urinal connected thereto. Overflows supplied as original parts with the fixture shall be of sufficient size to prevent tank flooding at the maximum rate at which the tank is supplied with water under normal operating conditions and when installed per manufacturer's instructions.

#### **412.0 Floor Drains and Shower Stalls.**

**412.1** Floor drains shall be considered plumbing fixtures, and each such drain shall be provided with an approved, type strainer having a waterway equivalent to the area of the tailpiece. Floor drains, floor receptors, and shower drains shall be of an approved type, suitably flanged to provide a watertight joint in the floor.

**412.2 Location of Floor Drains.** Floor drains shall be installed in the following areas:

**412.2.1** Toilet rooms containing two (2) or more water closets or a combination of one (1) water closet and one (1) urinal, except in a dwelling

unit. The floor shall slope toward the floor drains.

#### 412.2.2 Commercial Kitchens.

**412.2.3** Laundry rooms in commercial buildings and common laundry facilities in multi-family dwelling buildings.

**412.3 Food Storage Areas.** If drains are provided in storerooms, walk-in freezers, walk-in coolers, refrigerated equipment, or other locations where food is stored, such drains shall have indirect waste piping. Separate waste pipes shall be run from each food storage area, each with an indirect connection to the building sanitary drainage system. Traps shall be provided if required under Section 801.2.2 of this code and shall be vented.

Indirect drains may be located in freezers or other spaces where freezing temperatures are maintained, provided that traps, when supplied, are located where the seal will not freeze. Otherwise, the floor of the freezer shall be sloped to a floor drain located outside of the storage compartment.

**412.4 Floor Slope.** Floors shall be sloped to floor drains where drainage occurs on a regular or frequent basis, or as otherwise required by the Authority Having Jurisdiction.

**412.5** Shower receptors are plumbing fixtures and shall conform to the general requirements therefor contained in Section 401.0. Each such shower receptor shall be constructed of vitrified china or earthenware, ceramic tile, porcelain-enameled metal, or of such other material as may be acceptable to the Authority Having Jurisdiction. No shower receptor shall be installed unless it conforms to acceptable standards as referenced in Table 14-1 or until a specification or a prototype or both of such receptor has first been submitted to and approval obtained from the Authority Having Jurisdiction.

**412.6** Each shower receptor shall be an approved type and be so constructed as to have a finished dam, curb, or threshold which is at least one (1) inch (25.4 mm) lower than the sides and back of such receptor. In no case shall any dam or threshold be less than two (2) inches (51 mm) or more than nine (9) inches (229 mm) in depth when measured from the top of the dam or threshold to the top of the drain. Each such receptor shall be provided with an integral nailing flange to be located where the receptor meets the vertical surface of the finished interior of the shower compartment. The flange shall be watertight and extend vertically a minimum of one (1) inch (25.4 mm) above the top of the sides of the receptor. The finished floor of the receptor shall slope uniformly from the sides toward the drain not less than one-quarter (1/4) inch per foot (20.9 mm/m), nor more than one-half (1/2) inch per

foot (41.8 mm/m). Thresholds shall be of sufficient width to accommodate a minimum twenty-two (22) inch (559 mm) door. Shower doors shall open so as to maintain a minimum twenty-two (22) inch (559 mm) unobstructed opening for egress.

**Exception:** Showers which are designed to comply with the accessibility standards listed in Table 14-1.

**412.7** All shower compartments, regardless of shape, shall have a minimum finished interior of one thousand twenty-four (1024) square inches (0.66 m<sup>2</sup>) and shall also be capable of encompassing a thirty (30) inch (750 mm) circle. The minimum required area and dimensions shall be measured at a height equal to the top of the threshold and at a point tangent to its centerline. The minimum area and dimensions shall be maintained to a point seventy (70) inches (1778 mm) above the shower drain outlet with no protrusions other than the fixture valve or valves, shower head, soap dishes, shelves, and safety grab bars or rails. Fold-down seats in accessible shower stalls shall be permitted to protrude into the thirty (30) inch (750 mm) circle.

**Exception:** Showers which are designed to comply with the accessibility standards listed in Table 14-1. (See TIA on page vi)

**412.8** When the construction of on-site built-up shower receptors is permitted by the Authority Having Jurisdiction, one of the following means shall be employed:

- (1) Shower receptors built directly on the ground:

Shower receptors built directly on the ground shall be watertight and shall be constructed from approved type dense, nonabsorbent and non-corrosive materials. Each such receptor shall be adequately reinforced, shall be provided with an approved flanged floor drain designed to make a watertight joint in the floor, and shall have smooth, impervious, and durable surfaces.

- (2) Shower receptors built above ground:

When shower receptors are built above ground, the sub-floor and rough side of walls to a height of not less than three (3) inches (76 mm) above the top of the finished dam or threshold shall be first lined with sheet plastic,\* lead,\* or copper\* or shall be lined with other durable and watertight materials.

All lining materials shall be pitched one-quarter (1/4) inch per foot (20.9 mm/m) to weep holes in the sub-drain of a smooth and solidly

formed sub-base. All such lining materials shall extend upward on the rough jambs of the shower opening to a point no less than three (3) inches (76 mm) above the top of the finished dam or threshold and shall extend outward over the top of the rough threshold and be turned over and fastened on the outside face of both the rough threshold and the jambs.

Non-metallic shower sub-pans or linings may be built up on the job site of not less than three (3) layers of standard, grade fifteen (15) pound (6.8 kg) asphalt impregnated roofing felt. The bottom layer shall be fitted to the formed sub-base and each succeeding layer thoroughly hot-mopped to that below. All corners shall be carefully fitted and shall be made strong and watertight by folding or lapping, and each corner shall be reinforced with suitable webbing hot-mopped in place. All folds, laps, and reinforcing webbing shall extend at least four (4) inches (102 mm) in all directions from the corner and all webbing shall be of approved type and mesh, producing a tensile strength of not less than fifty (50) psi (344.5 kPa) in either direction. Non-metallic shower sub-pans or linings may also consist of multi-layers of other approved equivalent materials suitably reinforced and carefully fitted in place on the job site as elsewhere required in this section.

Linings shall be properly recessed and fastened to approved backing so as not to occupy the space required for the wall covering and shall not be nailed or perforated at any point which may be less than one (1) inch (25.4 mm) above the finished dam or threshold. An approved type sub-drain shall be installed with every shower sub-pan or lining. Each such sub-drain shall be of the type that sets flush with the sub-base and shall be equipped with a clamping ring or other device to make a tight connection between the lining and the drain. The sub-drain shall have weep holes into the waste line. The weep holes located in the sub-drain clamping ring shall be protected from clogging.

All shower lining materials shall conform to approved standards acceptable to the Authority Having Jurisdiction.

\*Lead and copper sub-pans or linings shall be insulated from all conducting substances other than their connecting drain by fifteen (15) pound (6.8 kg) asphalt felt or its equivalent and no lead pan or liner

shall be constructed of material weighing less than four (4) pounds per square foot (19.5 kg/m<sup>2</sup>). Copper pans or liners shall be at least No. 24 B & S Gauge (0.02 inches) (0.5 mm). Joints in lead pans or liners shall be burned. Joints in copper pans or liners shall be soldered or brazed. Plastic pans shall not be coated with asphalt-based materials.

**412.8.1 Tests for Shower Receptors.** Shower receptors shall be tested for watertightness by filling with water to the level of the rough threshold. The test plug shall be so placed that both upper and under sides of the sub-pan shall be subjected to the test at the point where it is clamped to the drain.

**412.9** Floors of public shower rooms shall have a non-skid surface and shall be drained in such a manner that waste water from one bather will not pass over areas occupied by other bathers. Gutters in public or gang shower rooms shall have rounded corners for easy cleaning and shall be sloped not less than two (2) percent toward drains. Drains in gutters shall be spaced not more than eight (8) feet (2438 mm) from side walls nor more than sixteen (16) feet (4879 mm) apart.

**412.10 DELETED.**

**412.11 Location of Valves and Heads.** Control valves and shower heads shall be located on the sidewall of shower compartments or be otherwise arranged so that the shower head does not discharge directly at the entrance to the compartment and the bather can adjust the valves prior to stepping into the shower spray.

**412.12 Water Supply Riser.** Every water supply riser from the shower valve to the shower head outlet, whether exposed or not, shall be securely attached to the structure.

**413.0 Minimum Number of Required Fixtures.**

**413.1 Fixture Count.** Plumbing fixtures shall be provided for the type of building occupancy and in the minimum number shown in Table 4-1.

**413.2 Access to Fixtures.**

**413.2.1** In multi-story buildings, accessibility to the required fixtures shall not exceed one (1) vertical story.

**413.2.2** Fixtures accessible only to private offices shall not be counted to determine compliance with this section.

**413.3 Separate Facilities.**

Separate toilet facilities shall be provided for each sex.

**Exceptions:**

(1) Residential installations.

- (2) In occupancies serving ten (10) or fewer people, one (1) toilet facility, designed for use by no more than one (1) person at a time, shall be permitted for use by both sexes.
- (3) In business and mercantile occupancies with a total floor area of fifteen hundred (1500) square feet (139.5 m<sup>2</sup>) or less, one (1) toilet facility, designed for use by no more than one (1) person at a time, shall satisfy the requirements for serving customers and employees of both sexes.

#### **413.4 Fixture Requirements for Special Occupancies.**

**413.4.1** Additional fixtures may be required when unusual environmental conditions or special activities are encountered.

**413.4.2** In food preparation areas, fixture requirements may be dictated by health codes.

**413.4.3** Types of occupancy not shown in Table 4-1 shall be considered individually by the Authority Having Jurisdiction.

#### **413.5 Facilities in Mercantile and Business Occupancies Serving Customers.**

**413.5.1** Requirements for customers and employees shall be permitted to be met with a single set of restrooms accessible to both groups. The required number of fixtures shall be the greater of the required number for employees or the required number for customers.

**413.5.2** Fixtures for customer use shall be permitted to be met by providing a centrally located facility accessible to several stores. The maximum distance from entry to any store to this facility shall not exceed five hundred (500) feet (152.4 m).

**413.5.3** In stores with a floor area of one hundred fifty (150) square feet (13.9 m<sup>2</sup>) or less, the requirement to provide facilities for employees shall be permitted to be met by providing a centrally located facility accessible to several stores. The maximum distance from entry to any store to this facility shall not exceed three hundred (300) feet (91.4 m).

**413.6 Food Service Establishments.** Food service establishments with an occupant load of one hundred (100) or more shall be provided with separate facilities for employees and customers. Customer and employee facilities may be combined for occupant loads less than one hundred (100).

#### **413.7 Toilet Facilities for Workers.**

Suitable toilet facilities shall be provided and maintained in a sanitary condition for the use of workers during construction.

#### **414.0 Fixtures and Fixture Fittings for Persons with Disabilities.**

Plumbing fixtures and fixture fittings for persons with disabilities shall conform to the appropriate standards referenced in Table 14-1 of this code.

#### **414.1 Limitation of Hot Water Temperature for Public Lavatories.**

Hot water delivered from public-use lavatories shall be limited to a maximum temperature of 120°F. The water heater thermostat shall not be considered a control for meeting this provision.

#### **415.0 Whirlpool Bathtubs.**

Unless otherwise listed, all whirlpool bathtubs shall comply with the following requirements:

**415.1** A removable panel of sufficient dimension shall be provided to access the pump.

**415.2** The circulation pump shall be located above the crown weir of the trap.

**415.3** The pump and the circulation piping shall be self-draining to minimize water retention in accordance with standards referenced in Table 14-1.

**415.4** Suction fittings on whirlpool bathtubs shall comply with the listed standards.

#### **416.0 Installation of Fixture Fittings.**

Where two separate handles control the hot and cold water, the left-hand control of the faucet when facing the fixture fitting outlet shall provide the means to alter the hot water temperature from the fixture fitting.

Single-handle mixing valves shall have the flow of hot water correspond to the markings on the fitting.

#### **417.0 Bidets.**

**417.1 Materials.** Bidets shall conform to the standards listed in Table 14-1.

**417.2 Backflow Protection.** The water supply to the bidet shall be protected according to Chapter 6, which allows for an airgap or vacuum breaker.

#### **418.0 DELETED.**

#### **419.0 Future Fixtures.**

When provision is made for the future installation of fixtures, those provided for shall be considered in determining the required sizes of drain pipes. Construction for future installations shall be terminated with a plugged fitting or fittings. Where the plugged fitting is at the point where the trap of a fixture may be installed, the plumbing system for such fixture shall be complete and conform with all plumbing requirements of this code.

**420.0 Shower and Tub-Shower Combination Control Valves.**

Showers and tub-shower combinations in all buildings shall be provided with individual control valves of the pressure balance, thermostatic, or combination pressure balance/thermostatic mixing valve type that provide scald and thermal shock protection. These valves shall conform to ASSE 1016. Gang showers, when supplied with a single temperature-controlled water supply pipe, may be controlled by a master thermostatic mixing valve in lieu of individually controlled pressure balance, thermostatic, or

combination pressure balance/thermostatic mixing valves. Handle position stops shall be provided on such valves and shall be adjusted per the manufacturer’s instructions to deliver a maximum mixed water setting of 120°F (49°C). The water heater thermostat shall not be considered a suitable control for meeting this provision.

**421.0 Limitation of Hot Water in Bathtubs.** The maximum hot water temperature discharging from the bathtub filler shall be 120°F.

**TABLE 4-1  
Minimum Plumbing Facilities<sup>1</sup>**

Each building shall be provided with sanitary facilities, including provisions for the physically handicapped as prescribed by the Department Having Jurisdiction. For requirements for the handicapped, ICC/ANSI A117.1, Accessible and Usable Buildings and Facilities, may be used. The total occupant load shall be determined by minimum exiting requirements. The minimum number of fixtures shall be calculated at fifty (50) percent male and fifty (50) percent female based on the total occupant load.

Type of Building or Occupancy <sup>2</sup>	Water Closets <sup>14</sup> (Fixtures per Person)	Urinals <sup>5, 10</sup> (Fixtures per Person)	Lavatories (Fixtures per Person)	Bathtubs or Showers (Fixtures per Person)	Drinking Fountains <sup>3, 13</sup> (Fixtures per Person)
Assembly places – theatres, auditoriums, convention halls, etc.– for permanent employee use	Male 1: 1-15 2: 16-35 3: 36-55 Over 55, add 1 fixture for each additional 40 persons. Female 1: 1-15 3: 16-35 4: 36-55	Male 0: 1-9 1: 10-50 Add one fixture for each additional 50 males.	Male 1 per 40 Female 1 per 40		
Assembly places – theatres, Auditoriums, Convention Halls, etc. – for public use	Male 1: 1-100 2: 101-200 3: 201-400 Over 400, add one fixture for each additional 500 males and 1 for each additional 125 females. Female 3: 1-50 4: 51-100 8: 101-200 11: 201-400	Male 1: 1-100 2: 101-200 3: 201-400 4: 401-600 Over 600 add 1 fixture for each additional 300 males.	Male 1: 1-200 2: 201-400 3: 401-750 Over 750, add one fixture for each additional 500 persons. Female 1: 1-200 2: 201-400 3: 401-750		1: 1-150 2: 151-400 3: 401-750 Over 750, add one fixture for each additional 500 persons.
Dormitories <sup>9</sup> – School or Labor	Male 1 per 10 Add 1 fixture for each additional 25 males (over 10) and 1 for each additional 20 females (over 8). Female 1 per 8	Male 1 per 25 Over 150, add 1 fixture for each additional 50 males.	Male 1 per 12 Over 12 add one fixture for each additional 20 males and 1 for each 15 additional females. Female 1 per 12	1 per 8 For females, add 1 bathtub per 30. Over 150, add 1 per 20.	1 per 150 <sup>12</sup>
Dormitories – for staff use	Male 1: 1-15 2: 16-35 3: 36-55 Over 55, add 1 fixture for each additional 40 persons. Female 1: 1-15 3: 16-35 4: 36-55	Male 1 per 50	Male 1 per 40 Female 1 per 40	1 per 8	
Dwellings <sup>4</sup> Single dwelling Multiple dwelling or apartment house	1 per dwelling 1 per dwelling or apartment unit		1 per dwelling 1 per dwelling or apartment unit	1 per dwelling 1 per dwelling or apartment unit	
Hospital waiting rooms	1 per room		1 per room		1 per 150 <sup>12</sup>
Hospitals – for employee use	Male 1: 1-15 2: 16-35 3: 36-55 Over 55, add 1 fixture for each additional 40 persons. Female 1: 1-15 3: 16-35 4: 36-55	Male 0: 1-9 1: 10-50 Add one fixture for each additional 50 males.	Male 1 per 40 Female 1 per 40		



Table 4-1 continued

UNIFORM PLUMBING CODE

Type of Building or Occupancy <sup>2</sup>	Water Closets <sup>14</sup> (Fixtures per Person)	Urinals <sup>5,10</sup> (Fixtures per Person)	Lavatories (Fixtures per Person)	Bathtubs or Showers (Fixtures per Person)	Drinking Fountains <sup>3,13</sup> (Fixtures per Person)
Hospitals Individual room ward room	1 per room 1 per 8 patients		1 per room 1 per 10 patients	1 per room 1 per 20 patients	1 per 150 <sup>12</sup>
Industrial <sup>6</sup> warehouses workshops, foundries, and similar establishments – for employee use	Male      Female 1: 1-10      1: 1-10 2: 11-25      2: 11-25 3: 26-50      3: 26-50 4: 51-75      4: 51-75 5: 76-100      5: 76-100 Over 100, add 1 fixture for each additional 30 persons		Up to 100, 1 per 10 persons  Over 100, 1 per 15 persons <sup>7,8</sup>	1 shower for each 15 persons exposed to excessive heat or to skin contam- ination with poison- ous, infectious, or irritating material	1 per 150 <sup>12</sup>
Institutional – other than hospitals or penal institutions (on each occupied floor)	Male      Female 1 per 25      1 per 20	Male 0: 1-9 1: 10-50 Add one fixture for each additional 50 males.	Male      Female 1 per 10      1 per 10	1 per 8	1 per 150 <sup>12</sup>
Institutional – other than hospitals or penal institutions (on each occupied floor) – for employee use	Male      Female 1: 1-15      1: 1-15 2: 16-35      3: 16-35 3: 36-55      4: 36-55 Over 55, add 1 fixture for each additional 40 persons.	Male 0: 1-9 1: 10-50 Add one fixture for each additional 50 males.	Male      Female 1 per 40      1 per 40	1 per 8	1 per 150 <sup>12</sup>
Office or public buildings	Male      Female 1: 1-100      3: 1-50 2: 101-200      4: 51-100 3: 201-400      8: 101-200 11: 201-400 Over 400, add one fixture for each additional 500 males and 1 for each additional 150 females.	Male 1: 1-100 2: 101-200 3: 201-400 4: 401-600 Over 600, add 1 fixture for each additional 300 males.	Male      Female 1: 1-200      1: 1-200 2: 201-400      2: 201-400 3: 401-750      3: 401-750 Over 750, add one fixture for each additional 500 persons.		1 per 150 <sup>12</sup>
Office or public buildings – for employee use	Male      Female 1: 1-15      1: 1-15 2: 16-35      3: 16-35 3: 36-55      4: 36-55 Over 55, add 1 fixture for each additional 40 persons.	Male 0: 1-9 1: 10-50 Add one fixture for each additional 50 males.	Male      Female 1 per 40      1 per 40		
Penal institutions – for employee use	Male      Female 1: 1-15      1: 1-15 2: 16-35      3: 16-35 3: 36-55      4: 36-55 Over 55, add 1 fixture for each additional 40 persons.	Male 0: 1-9 1: 10-50 Add one fixture for each additional 50 males.	Male      Female 1 per 40      1 per 40		1 per 150 <sup>12</sup>
Penal institutions – for prison use Cell Exercise room	1 per cell 1 per exercise room	Male 1 per exercise room	1 per cell 1 per exercise room		1 per cell block floor 1 per exercise room
Restaurants, pubs, and Lounges <sup>11</sup>	Male      Female 1: 1-50      1: 1-50 2: 51-150      2: 51-150 3: 151-300      4: 151-300 Over 300, add 1 fixture for each additional 200 persons	Male 1: 1-150 Over 150, add 1 fixture for each additional 150 males.	Male      Female 1: 1-150      1: 1-150 2: 151-200      2: 151-200 3: 201-400      3: 201-400 Over 400, add 1 fixture for each additional 400 persons.		
Schools – for staff use All schools	Male      Female 1: 1-15      1: 1-15 2: 16-35      2: 16-35 3: 36-55      3: 36-55 Over 55, add 1 fixture for each additional 40 persons.	Male 1 per 50	Male      Female 1 per 40      1 per 40		
Schools – for student use Nursery	Male      Female 1: 1-20      1: 1-20 2: 21-50      2: 21-50 Over 50, add 1 fixture for each additional 50 persons		Male      Female 1: 1-25      1: 1-25 2: 26-50      2: 26-50 Over 50, add 1 fixture for each additional 50 persons		1 per 150 <sup>12</sup>
Elementary	Male      Female 1 per 30      1 per 25	Male 1 per 75	Male      Female 1 per 35      1 per 35		1 per 150 <sup>12</sup>
Secondary	Male      Female 1 per 40      1 per 30	Male 1 per 35	Male      Female 1 per 40      1 per 40		1 per 150 <sup>12</sup>

PLUMBING FIXTURES AND FIXTURE FITTINGS

Table 4-1 continued

Type of Building or Occupancy <sup>2</sup>	Water Closets <sup>14</sup> (Fixtures per Person)		Urinals <sup>5,10</sup> (Fixtures per Person)	Lavatories (Fixtures per Person)		Bathtubs or Showers (Fixtures per Person)	Drinking Fountains <sup>5,13</sup> (Fixtures per Person)
	Male	Female	Male	Male	Female		
Others (colleges, universities, adult centers, etc.)	1 per 40	1 per 30	1 per 35	1 per 40	1 per 40		1 per 150 <sup>12</sup>
Worship places Educational and Activities Unit	1 per 150	1 per 75	1 per 150	1 per 2 water closets			1 per 150 <sup>12</sup>
Worship places principal assembly place	1 per 150	1 per 75	1 per 150	1 per 2 water closets			1 per 150 <sup>12</sup>

<sup>1</sup> The figures shown are based upon one (1) fixture being the minimum required for the number of persons indicated or any fraction thereof.

<sup>2</sup> Building categories not shown on this table shall be considered separately by the Authority Having Jurisdiction.

<sup>3</sup> Drinking fountains shall not be installed in toilet rooms.

<sup>4</sup> Laundry trays. One (1) laundry tray or one (1) automatic washer standpipe for each dwelling unit or one (1) laundry tray or one (1) automatic washer standpipe, or combination thereof, for each twelve (12) apartments. Kitchen sinks, one (1) for each dwelling or apartment unit.

<sup>5</sup> For each urinal added in excess of the minimum required, one water closet may be deducted. The number of water closets shall not be reduced to less than two-thirds (2/3) of the minimum requirement.

<sup>6</sup> As required by ANSI Z4.1-1968, Sanitation in Places of Employment.

<sup>7</sup> Where there is exposure to skin contamination with poisonous, infectious, or irritating materials, provide one (1) lavatory for each five (5) persons.

<sup>8</sup> Twenty-four (24) lineal inches (610 mm) of wash sink or eighteen (18) inches (457 mm) of a circular basin, when provided with water outlets for such space, shall be considered equivalent to one (1) lavatory.

<sup>9</sup> Laundry trays, one (1) for each fifty (50) persons. Service sinks, one (1) for each hundred (100) persons.

<sup>10</sup> General. In applying this schedule of facilities, consideration shall be given to the accessibility of the fixtures. Conformity purely on a numerical basis may not result in an installation suited to the needs of the individual establishment. For example, schools should be provided with toilet facilities on each floor having classrooms.

a. Surrounding materials, wall, and floor space to a point two (2) feet (610 mm) in front of urinal lip and four (4) feet (1219 mm) above the floor, and at least two (2) feet (610 mm) to each side of the urinal shall be lined with non-absorbent materials.

b. Trough urinals shall be prohibited.

<sup>11</sup> A restaurant is defined as a business which sells food to be consumed on the premises.

a. The number of occupants for a drive-in restaurant shall be considered as equal to the number of parking stalls.

b. Employee toilet facilities shall not be included in the above restaurant requirements. Hand-washing facilities shall be available in the kitchen for employees.

<sup>12</sup> Where food is consumed indoors, water stations may be substituted for drinking fountains. Offices, or public buildings for use by more than six (6) persons shall have one (1) drinking fountain for the first one hundred fifty (150) persons and one (1) additional fountain for each three hundred (300) persons thereafter.

<sup>13</sup> There shall be a minimum of one (1) drinking fountain per occupied floor in schools, theatres, auditoriums, dormitories, offices, or public buildings.

<sup>14</sup> The total number of water closets for females shall be at least equal to the total number of water closets and urinals required for males.



# CHAPTER 5

## WATER HEATERS

### Part I

#### 501.0 General.

The regulations of this chapter shall govern the construction, location, and installation of fuel-burning and other water heaters heating potable water, together with all chimneys, vents, and their connectors. The minimum capacity for water heaters shall be in accordance with the first hour rating listed in Table 5-1. All design, construction, and workmanship shall be in conformity with accepted engineering practices, manufacturer's installation instructions, and applicable standards and shall be of such character as to secure the results sought to be obtained by this code. No water heater shall be hereinafter installed which does not comply in all respects with the type and model of each size thereof approved by the Authority Having Jurisdiction. A list of accepted gas equipment standards is included in Table 14-1.

#### 502.0 Definitions.

**502.1 Appliance Categorized Vent Diameter/Area.** The minimum vent area/diameter permissible for Category I appliances to maintain a nonpositive vent static pressure when tested in accordance with nationally recognized standards. [extracted from NFPA 54]

**502.2 Chimney.** (See also Gas Vent, and Venting System.) One or more passageways, vertical or nearly so, for conveying flue or vent gases to the outside atmosphere. [extracted from NFPA 54]

**502.3 Chimney, Factory-Built.** A chimney composed of listed factory-built components assembled in accordance with the terms of listing to form the completed chimney. [extracted from NFPA 54]

**502.4 Chimney, Masonry.** A field-constructed chimney of solid masonry units, bricks, stones, listed masonry chimney units, or reinforced portland cement concrete, lined with suitable chimney flue liners. [extracted from NFPA 54]

**502.5 Chimney, Metal.** A field-constructed chimney of metal. [extracted from NFPA 54]

**502.6 Combustible Material.** As pertaining to materials adjacent to or in contact with heat-producing appliances, vent connectors, gas vents, chimneys, steam and hot water pipes, and warm air ducts, shall mean materials made of or surfaced with wood, compressed paper, plant fibers, or other materials that are capable of being ignited and burned. Such material shall be considered combustible even though flame-proofed, fire-retardant treated, or plastered. [extracted from NFPA 54]

**502.7 Direct-Vent Appliance.** Appliances that are constructed and installed so that all air for combustion is derived directly from the outside atmosphere and all flue gases are discharged to the outside atmosphere.

**502.8 Flue Collar.** That portion of an appliance designed for the attachment of a draft hood, vent connector, or venting system. [extracted from NFPA 54]

**502.9 Gas Vent, Type B.** A vent for venting listed gas appliances with draft hoods and other Category I gas appliances listed for use with Type B gas vents.

**502.10 Gas Vent, Type L.** A vent for venting appliances listed for use with Type L vents and appliances listed for use with Type B gas vents.

**502.11 Vent.** A passageway used to convey flue gases from gas utilization equipment or their vent connectors to the outside atmosphere. [extracted from NFPA 54]

**502.12 Vent Connector.** The pipe or duct that connects a fuel-gas-burning appliance to a vent or chimney. [extracted from NFPA 54]

**502.13 Venting System.** A continuous open passageway from the flue collar or draft hood of a gas-burning appliance to the outside atmosphere for the purpose of removing flue or vent gases. [extracted from NFPA 54]

TABLE 5-1<sup>1</sup> FIRST HOUR RATING

Number of Bathrooms	1 to 1.5			2 to 2.5				3 to 3.5			
	1	2	3	2	3	4	5	3	4	5	6
Number of Bedrooms											
First Hour Rating, <sup>2</sup> Gallons	42	54	54	54	67	67	80	67	80	80	80

Note:

1 The first hour rating is found on the "Energy Guide" label.

2 Non-storage and solar water heaters shall be sized to meet the appropriate first hour rating as shown in the table.

**502.14 Water Heater.** An appliance for supplying hot water for domestic or commercial purposes. [extracted from NFPA 54]

### 503.0 Permits.

It shall be unlawful for any person to install, remove, or replace or cause to be installed, removed, or replaced any water heater without first obtaining a permit from the Authority Having Jurisdiction to do so.

### 504.0 Inspection.

**504.1 Inspection of Chimneys or Vents.** This inspection shall be made after all chimneys, vents, or parts thereof, authorized by the permit, have been installed and before any such vent or part thereof has been covered or concealed.

**504.2 Final Water Heater Inspection.** This inspection shall be made after all work authorized by the permit has been installed. The Authority Having Jurisdiction will make such inspection as deemed necessary to be assured that the work has been installed in accordance with the intent of this code. No equipment or part thereof shall be covered or concealed until the same has been inspected and approved by the Authority Having Jurisdiction.

### 505.0 Water Heater Requirements.

#### 505.1 Location.

Water heater installations in bedrooms and bathrooms shall be of the direct-vent type. [NFPA 54:9.28.1.1]

**505.2** Water heaters of other than the direct-vent type shall be located as close as practical to the chimney or gas vent. [NFPA 54:9.28.1.2]

#### 505.3 Clearance.

**505.3.1** The clearances shall not be such as to interfere with combustion air, draft hood clearance and relief, and accessibility for servicing. Listed water heaters shall be installed in accordance with their listing and the manufacturers' instructions.

**505.3.2** Unlisted water heaters shall be installed with a clearance of 12 in. (300 mm) on all sides and rear. Combustible floors under unlisted water heaters shall be protected in an approved manner. [NFPA 54:9.28.2.2]

**505.4 Pressure-Limiting Devices.** A water heater installation shall be provided with overpressure protection by means of an approved listed device, and installed in accordance with the terms of its listing and the manufacturer's instructions. [NFPA 54: 9.28.3]

**505.5 Temperature-Limiting Devices.** Water heater installation or a hot water storage vessel installation

shall be provided with overtemperature protection by means of an approved listed device installed in accordance with the terms of its listing and the manufacturers' instructions. [NFPA 54: 9.28.4]

**505.6 Temperature, Pressure, and Vacuum Relief Devices.** The installation of temperature, pressure, and vacuum relief devices or combinations thereof, and automatic gas shutoff devices, shall be in accordance with the terms of their listing and the manufacturers' instructions. A shutoff valve shall not be placed between the relief valve and the water heater or on discharge pipes between such valves and the atmosphere. The hourly Btu discharge capacity or the rated steam relief capacity of the device shall not be less than the input rating of the water heater. [NFPA 54: 9.28.5]

### 506.0 Oil-Burning and Other Water Heaters.

**506.1** Water heaters deriving heat from fuels or types of energy other than gas shall be constructed and installed in accordance with approved standards in a manner satisfactory to the Authority Having Jurisdiction. Vents or chimneys for such appliances shall be approved types and shall be made for an adequate supply of air for combustion and for adequate ventilation of heater rooms or compartments. Each such appliance shall be installed in an approved location satisfactory to the Authority Having Jurisdiction and to local and state fire-prevention agencies.

**506.2** All storage-type water heaters and hot water boilers deriving heat from fuels or types of energy other than gas, shall be provided with, in addition to the primary temperature controls, an overtemperature safety protection device constructed, listed, and installed in accordance with nationally recognized applicable standards for such devices and a combination temperature and pressure relief valve.

**506.3** Oil-fired water heaters shall be installed in accordance with NFPA 31, *Standard for the Installation of Oil-Burning Equipment*.

### 507.0 Air for Combustion and Ventilation.

#### 507.1 General.

**507.1.1** Air for combustion, ventilation, and dilution of flue gases for gas utilization equipment installed in buildings shall be obtained by application of one of the methods covered in 507.2.1–507.7. Gas utilization equipment of other than natural draft and Category I vented appliances shall be provided with combustion, ventilation, and dilution air in accordance with the equipment manufacturer's

instructions. Where infiltration does not provide the necessary air, outdoor air shall be introduced in accordance with methods covered in 507.4 – 507.7.

**Exception No. 1:** This provision shall not apply to direct-vent appliances.

**Exception No. 2:** Type 1 clothes dryers that are provided with makeup air in accordance with section NFPA 54:9.4.3.

*(The following references were extracted from NFPA 54.)*

3.3.43 *Clothes Dryer.* A device used to dry wet laundry by means of heat derived from the combustion of fuel gases.

3.3.44 *Clothes Dryer, Type 1. Factory-built package, multiply produced.* Primarily used in the family living environment. May or may not be coin-operated for public use.

9.4.2 *Exhausting to Outdoors.* Type 1 and Type 2 clothes dryers shall be exhausted to the outside air.

9.4.3 *Provisions for Make-Up Air.*

9.4.3.1 *Make-up air shall be provided for Type 1 clothes dryers in accordance with the manufacturers' installation instructions.*

**507.1.2** Gas appliances of other than natural draft design and other than Category I vented appliances shall be provided with combustion, ventilation, and dilution air in accordance with the appliance manufacturer's instructions.

**507.1.3** Where used, a draft hood or a barometric draft regulator shall be installed in the same room or enclosure as the equipment served so as to prevent any difference in pressure between the hood or regulator and the combustion air supply.

**507.1.4** Makeup air requirements for the operation of exhaust fans, kitchen ventilation systems, clothes dryers, and fireplaces shall be considered in determining the adequacy of a space to provide combustion air requirements. [NFPA 54:8.3.1.5]

**Table 5-2 DELETED.**

**507.2 Indoor Combustion Air.** The required volume of indoor air shall be determined in accordance with method 507.2.1 or 507.2.2 except that where the air infiltration rate is known to be less than 0.40 ACH, method 507.2.2 shall be used. The total required volume shall be the sum of the required volume calculated for all appliances located within the space. Rooms communicating directly with the space in which the appliances are installed through openings not furnished with doors and through combustion air openings sized and located in accordance with 507.3 are considered a part of the required volume.

**507.2.1 Standard Method:** The minimum required volume shall be 50 cubic feet per 1000 Btu/hour (4.8 m<sup>3</sup>/kW).

**507.2.2 Known Air Infiltration Rate Method:** Where the air infiltration rate of a structure is known, the minimum required volume shall be determined as follows:

For appliances having other than fan-assisted combustion systems: Calculate using Equation 5-1 but no smaller than 35 cubic feet per 1000 Btu/hour (3.4 m<sup>3</sup>/kW).

For fan-assisted combustion system appliances: Calculate using Equation 5-2 but no smaller than 25 cubic feet per 1000 Btu/hour (2.4 m<sup>3</sup>/kW).

[NFPA 54:8.3.2.2]

**Equation 5-1:**

Required Volume<sub>other</sub> > (21 ft<sup>3</sup> / ACH) × (I<sub>other</sub> / 1,000 Btu/h)

**Equation 5-2:**

Required Volume<sub>fan</sub> > (15 ft<sup>3</sup> / ACH) × (I<sub>fan</sub> / 1,000 Btu/h)

Where:

I<sub>other</sub> = All Appliances other than Fan-Assisted Input in Btu per hour

I<sub>fan</sub> = Fan-Assisted Appliance Input in Btu/hour  
ACH = Air Change per Hour (Percent of volume of space exchanged per hour, expressed as a decimal)

**507.3 Indoor Opening Size and Location.**

Openings used to connect indoor spaces shall be sized and located in accordance with the following.

- (1) Combining spaces on the same story. Each opening shall have a minimum free area of 1 in.<sup>2</sup>/1000 Btu/h (220 mm<sup>3</sup>/kW) of the total input rating of all gas utilization equipment in the space, but not less than 100 in.<sup>2</sup> (0.06 m<sup>2</sup>). One opening shall commence within 12 in. (300 mm) of the top, and one opening shall commence within 12 in. (300 mm) of the bottom, of the enclosure [see Figure 5-12]. The minimum dimension of air openings shall be not less than 3 in. (80 mm).
- (2) Combining spaces in different stories. The volumes of spaces in different stories shall be considered as communicating spaces where such spaces are connected by one or more openings in doors or floors having a total minimum free area of 2 in.<sup>2</sup>/1000 Btu/h of total input rating of all gas utilization equipment. [NFPA 54:8.3.2.3(2)]

**507.4 Outdoor Combustion Air.** Outdoor combustion air shall be provided through openings to

the outdoors in accordance with methods 507.4.1 or 507.4.2. The minimum dimension of air openings shall not be less than 3 in. (80 mm).

**507.4.1 Two Permanent Openings Method:**

Two permanent openings, one commencing within 12 in. (300 mm) of the top and one commencing within 12 in. (300 mm) of the bottom of the enclosure shall be provided. The openings shall communicate directly, or by ducts, with the outdoors or spaces that freely communicate with the outdoors. [See Figure 5-8.]

- (1) Where directly communicating with the outdoors or where communicating to the outdoors through vertical ducts, each opening shall have a minimum free area of 1 in.<sup>2</sup>/4000 Btu/h (550 mm<sup>2</sup>/kW) of total input rating of all equipment in the enclosure. [See Figures 5-9 and 5-10.]
- (2) Where communicating with the outdoors through horizontal ducts, each opening shall have a minimum free area of 1 in.<sup>2</sup>/2000 Btu/h (1100 mm<sup>2</sup>/kW) of total input rating of all equipment in the enclosure. [See Figure 5-11]

**507.4.2 One Permanent Opening Method: (2)**

One permanent opening, commencing within 12 in. (300 mm) of the top of the enclosure, shall be provided. The equipment shall have clearances of at least 1 in. (25 mm) from the sides and back and 6 in. (160 mm) from the front of the appliance. The opening shall directly communicate with the outdoors or shall communicate through a vertical or horizontal duct to the outdoors or spaces that freely communicate with the outdoors [see Figure 5-12] and shall have a minimum free area of:

- (1) 1 in.<sup>2</sup>/3000 Btu/h (700 mm<sup>2</sup>/kW) of the total input rating of all equipment located in the enclosure, and
- (2) Not less than the sum of the areas of all vent connectors in the space. [NFPA 54: 8.3.3.2]

**507.5 Combination Indoor and Outdoor Combustion Air.** The use of a combination of indoor and outdoor combustion air shall be in accordance with 1 through 3 [see example calculation in NFPA 54 Annex J and this chapter – Part II].

**507.5.1 Indoor Openings.** Where used, openings connecting the interior spaces shall comply with Section 507.3.

**507.5.2** Outdoor openings shall be located in accordance with Section 507.4.1 and 507.4.2.

**507.5.3 Outdoor Openings Size.** The outdoor openings size shall be calculated in accordance with the following:

- (1) The ratio of interior spaces shall be the available volume of all communicating spaces divided by the required volume.
- (2) The outdoor size reduction factor shall be 1 minus the ratio of interior spaces.
- (3) The minimum size of outdoor openings shall be the full size of outdoor openings calculated in accordance with Section 507.4.1 or 507.4.2, multiplied by the reduction factor. The minimum dimension of air openings shall not be less than 3 in. (80 mm). [NFPA 54:8.3.4(3)(c)]

**507.6 Engineered Installations.** Engineered combustion air installations shall provide adequate supply of combustion, ventilation, and dilution air and shall be approved by the Authority Having Jurisdiction. [NFPA 54: 8.3.5]

**507.7 Mechanical Combustion Air Supply.** Where all combustion air is provided by a mechanical air supply system, the combustion air shall be supplied from outdoors at the minimum rate of 0.35 feet<sup>3</sup>/min per 1,000 Btu/h (0.034 m<sup>3</sup>/min per kW for all appliances located within the space.

**507.7.1** Where exhaust fans are installed, additional air shall be provided to replace the exhausted air.

**507.7.2** Each of the appliances served shall be interlocked to the mechanical air supply system to prevent main burner operation where the mechanical air supply system is not in operation.

**507.7.3** Where combustion air is provided by the building's mechanical ventilation system, the system shall provide the specified combustion air rate in addition to the required ventilation air. [NFPA 54: 8.3.6.3]

**507.8 RESERVED**

**507.9 Louvers and Grilles. (See TIA on page vii)**

- (A) The required size of openings for combustion, ventilation, and dilution air shall be based on the net free area of each opening. Where the free area through a design of louver or grille is known, it shall be used in calculating the size opening required to provide the free area specified. Where the design and free area are not known, it shall be assumed that wood louvers will have 25 percent free area and metal louvers and grilles will have 75 percent free area. Non-motorized louvers and grilles shall be fixed in the open position.
- (B) Motorized louvers shall be interlocked with the equipment so they are proven in the full open position prior to main burner ignition

and during main burner operation. Means shall be provided to prevent the main burner from igniting should the louver fail to open during burner startup and to shut down the main burner if the louvers close during burner operation. [NFPA 54: 8.3.7.2]

**507.10 Combustion Air Ducts.** Combustion air ducts shall comply with the following:

- (1) Ducts shall be of galvanized steel or an equivalent corrosion-resistant material.

**Exception:** Within dwelling units, unobstructed stud and joist spaces shall not be prohibited from conveying combustion air, provided that not more than one fireblock is removed.

- (2) Ducts shall terminate in an unobstructed space, allowing free movement of combustion air to the appliances.
- (3) Ducts shall serve a single space.
- (4) Ducts shall not service both upper and lower combustion air openings where both such openings are used. The separation between ducts serving upper and lower combustion air openings shall be maintained to the source of combustion air.
- (5) Ducts shall not be screened where terminating in an attic space.
- (6) Intakes for combustion air ducts located exterior to the building shall have the lowest side of the combustion air intake openings located at least 12 inches vertically from the adjoining grade level.
- (7) Horizontal upper combustion air ducts shall not slope downward toward the source of combustion air.
- (8) The remaining space surrounding a chimney liner, gas vent, special gas vent, or plastic piping installed within a masonry chimney flue, metal or factory-built chimney, shall not be used to supply combustion air, unless it is listed and shown in the manufacturer's installation instructions. [NFPA 54: 8.3.8]

**508.0 Other Water Heater Installation Requirements.**

**508.1** The Authority Having Jurisdiction may require the use of an approved dielectric insulator on the water piping connections of water heaters and related water heating equipment.

**508.2** In seismic design categories C, D, E, and F, water heaters shall be anchored or strapped to resist horizontal displacement due to earthquake motion. Strapping shall be at points within the upper one-

third (1/3) and lower one-third (1/3) of its vertical dimensions. At the lower point, a minimum distance of four (4) inches (102 mm) shall be maintained above the controls with the strapping.

**508.3** A water heater supported from the ground shall rest on level concrete or other approved base extending not less than three (3) inches (76 mm) above the adjoining ground level.

**508.4** When a water heater is located in an attic, attic-ceiling assembly, floor-ceiling assembly, or floor-subfloor assembly where damage may result from a leaking water heater, a watertight pan of corrosion-resistant materials shall be installed beneath the water heater with a minimum three-quarter (3/4) inch (20 mm) diameter drain to an approved location.

**508.5 Relief Valve Discharge.**

Discharge from a relief valve into a water heater pan shall be prohibited.

**508.6 Added or Converted Equipment.** When additional or replacement equipment is installed or an appliance is converted to gas from another fuel, the location in which the equipment is to be operated shall be checked to verify the following:

**508.6.1** Air for combustion and ventilation is provided where required, in accordance with the provisions of Section 507.0. Where existing facilities are not adequate, they shall be upgraded to Section 507.0 specifications.

**508.6.2** The installation components and equipment meet the clearances to combustible material provisions of NFPA 54 8.2.2. It shall be determined that the installation and operation of the additional or replacement equipment does not render the remaining equipment unsafe for continued operation.

*(The following reference was extracted from NFPA 54.)*

*8.2.2 Clearance to Combustible Materials. Gas utilization equipment and their vent connectors shall be installed with clearances from combustible material so their operation will not create a hazard to persons or property. Minimum clearances between combustible walls and the back and sides of various conventional types of equipment and their vent connectors are specified in Chapters 9 and 10. (Reference can also be made to NFPA 211, Standard for Chimneys, Fireplaces, Vents, and Solid Fuel-Burning Appliances.)*

**508.6.3** The venting system is constructed and sized in accordance with the provisions of this chapter. Where the existing venting system is not adequate, it shall be upgraded to comply with this chapter. [NFPA 54: 8.1.2]



**508.7 Types of Gases.** It shall be determined whether the gas-utilization equipment has been designed for use with the gas to which it will be connected. No attempt shall be made to convert the equipment from the gas specified on the rating plate for use with a different gas without consulting the installation instruction, the serving gas supplier, or the equipment manufacturer for complete instructions. [NFPA 54: 8.1.3]

**508.8 Safety Shutoff Devices for Unlisted LP-Gas Equipment Used Indoors.** Unlisted gas utilization equipment for use with undiluted liquefied petroleum gases and installed indoors shall be equipped with safety shutoff devices of the complete shutoff type. [NFPA 54: 8.1.4]

**508.9 Use of Air or Oxygen Under Pressure.** Where air or oxygen under pressure is used in connection with the gas supply, effective means such as a back-pressure regulator and relief valve shall be provided to prevent air or oxygen from passing back into the gas piping. Where oxygen is used, installation shall be in accordance with NFPA 51, *Standard for the Design and Installation of Oxygen-Fuel Gas Systems for Welding, Cutting, and Allied Processes*. [NFPA 54: 8.1.5]

**508.10 Protection of Gas Equipment from Fumes or Gases Other than Products of Combustion.** Non-direct-vent type gas appliances installed in beauty shops, barber shops, or other facilities where chemicals that generate corrosive or flammable products such as aerosol sprays are routinely used, shall be located in an equipment room separate or partitioned off from other areas with provisions for combustion and dilution air from outdoors. Direct vent equipment shall be installed in accordance with the appliance manufacturer's installation instructions. [NFPA 54: 8.1.6]

**508.11 Process Air.** In addition to air needed for combustion in commercial or industrial processes, process air shall be provided as required for cooling of equipment or material, controlling dew point, heating, drying, oxidation, dilution, safety exhaust, odor control, air for compressors and for comfort and proper working conditions for personnel. [NFPA 54: 8.1.7]

**508.12 Building Structural Members.**

**508.12.1** Structural members of a building shall not pass through gas utilization equipment having an operating temperature in excess of 500°F (260°C).

**508.12.2** Structural members passing through gas utilization equipment having an operating temperature of 500°F (260°C) or less shall be of noncombustible material. Building columns, girders, beams, or trusses shall not be installed

within equipment, unless insulation and ventilation are provided to avoid all deterioration in strength and linear expansion of the building structure in either a vertical or a horizontal direction.

**508.12.3** Gas utilization equipment shall be furnished either with load-distributing bases or with a sufficient number of supports to prevent damage to either the building structure or equipment.

**508.12.4** At the locations selected for installation of gas utilization equipment, the dynamic and static load-carrying capacities of the building structure shall be checked to determine whether they are adequate to carry the additional loads. The equipment shall be supported and shall be connected to the piping so as not to exert undue stress on the connections. [NFPA 54: 8.1.8]

**508.13 Flammable Vapors.** Gas appliances shall not be installed in areas where the open use, handling, or dispensing of flammable liquids occurs, unless the design, operation, or installation reduces the potential of ignition of the flammable vapors. Gas utilization equipment installed in compliance with 508.14, 508.15, or 508.16 shall be considered to comply with the intent of this provision. [NFPA 54: 8.1.9]

**508.14 Installation in Residential Garages.**

- (1) Gas utilization equipment in residential garages and in adjacent spaces that open to the garage and are not part of the living space of a dwelling unit shall be installed so that all burners and burner-ignition devices are located not less than 18 in. (450 mm) above the floor unless listed as flammable vapor ignition resistant.
- (2) Such equipment shall be located or protected so it is not subject to physical damage by a moving vehicle.
- (3) When appliances are installed in a separate, enclosed space having access only from outside of the garage, such equipment may be installed at floor level, providing the required combustion air is taken from the exterior of the garage. [NFPA 54: 8.1.10.3]

**508.15 Installation in Commercial Garages.**

**508.15.1 Parking Structures.** Gas utilization equipment installed in enclosed, basement, and underground parking structures shall be installed in accordance with NFPA 88A, *Standard for Parking Structures*.

**508.15.2 Repair Garages.** Gas utilization equipment installed in repair garages shall be

installed in a detached building or room, separated from repair areas by walls or partitions, floors, or floor ceiling assemblies that are constructed so as to prohibit the transmission of vapors and having a fire resistance rating of not less than 1 hour, and that have no openings in the wall separating the repair area within 8 ft (2.5 m) of the floor. Wall penetrations shall be firestopped. Air for combustion purposes shall be obtained from outside the building. The heating room shall not be used for the storage of combustible materials.

**Exception No. 1:** Overhead heaters where installed not less than 8 ft (2.5 m) above the floor shall be permitted.

**Exception No. 2:** Heating equipment for vehicle repair areas where there is no dispensing or transferring of Class I or Class II flammable or combustible liquids or liquefied petroleum gas shall be installed in accordance with NFPA 30A, Automotive and Marine Service Station Code. [NFPA 54: 8.1.11.2]

**508.16 Installation in Aircraft Hangars.** Heaters in aircraft hangars shall be installed in accordance with NFPA 409, *Standard on Aircraft Hangars*. [NFPA 54: 8.1.12]

**508.17 Gas Equipment Physical Protection.** Where it is necessary to locate gas utilization equipment close to a passageway traveled by vehicles or equipment, guardrails or bumper plates shall be installed to protect the equipment from damage. [NFPA 54: 8.1.13]

**508.18 Venting of Flue Gases.** Gas utilization equipment shall be vented in accordance with the provisions of this chapter and NFPA 54 Chapter 10. [NFPA 54: 8.1.14]

**508.19 Extra Device or Attachment.** No device or attachment shall be installed on any gas utilization equipment that could in any way impair the combustion of gas. [NFPA 54: 8.1.15]

**508.20 Adequate Capacity of Piping.** When additional gas utilization equipment is being connected to a gas piping system, the existing piping shall be checked to determine if it has adequate capacity. (See Section 1209.4.3.) Where inadequate, the existing system shall be enlarged as necessary, or separate gas piping of adequate capacity shall be run from the point of delivery to the equipment. [NFPA 54: 8.1.16]

**508.21 Avoiding Strain on Gas Piping.** Gas utilization equipment shall be supported and so connected to the piping as not to exert undue strain on the connections. [NFPA 54: 8.1.17]

**508.22 Gas Appliance Pressure Regulators.** Where the gas supply pressure is higher than that at which the gas utilization equipment is designed to operate or varies beyond the design pressure limits of the equipment, a gas appliance pressure regulator shall be installed. [NFPA 54: 8.1.18]

**508.23 Venting of Gas Appliance Pressure Regulators.** Venting of gas appliance pressure regulators shall comply with the following requirements:

**508.23.1** Gas appliance pressure regulators requiring access to the atmosphere for successful operation shall be equipped with vent piping leading outdoors or, if the regulator vent is an integral part of the equipment, into the combustion chamber adjacent to a continuous pilot, unless constructed or equipped with a vent limiting means to limit the escape of gas from the vent opening in the event of diaphragm failure.

**508.23.2** Vent limiting means shall be employed on listed gas appliance pressure regulators only.

**508.23.3** In the case of vents leading outdoors, means shall be employed to prevent water from entering this piping and also to prevent blockage of vents by insects and foreign matter.

**508.23.4** Under no circumstances shall a regulator be vented to the gas utilization equipment flue or exhaust system.

**508.23.5** In the case of vents entering the combustion chamber, the vent shall be located so the escaping gas will be readily ignited by the pilot and the heat liberated thereby will not adversely affect the normal operation of the safety shutoff system. The terminus of the vent shall be securely held in a fixed position relative to the pilot. For manufactured gas, the need for a flame arrester in the vent piping shall be determined.

**508.23.6** Vent lines from a gas appliance pressure regulator and a bleed lines from a diaphragm-type valve shall not be connected to a common manifold terminating in a combustion chamber. Vent lines shall not terminate in positive-pressure-type combustion chambers. [NFPA 54: 8.1.19]

**508.24 Bleed Lines for Diaphragm-Type Valves.** Bleed lines shall comply with the following requirements:

**508.24.1** Diaphragm-type valves shall be equipped to convey bleed gas to the outside atmosphere or into the combustion chamber adjacent to a continuous pilot.

**508.24.2** In the case of bleed lines leading outdoors, means shall be employed to prevent

water from entering this piping and also to prevent blockage of vents by insects and foreign matter.

**508.24.3** Bleed lines shall not terminate in the gas utilization equipment flue or exhaust system.

**508.24.4** In the case of bleed lines entering the combustion chamber, the bleed line shall be located so the bleed gas will be readily ignited by the pilot and the heat liberated thereby will not adversely affect the normal operation of the safety shutoff system. The terminus of the bleed line shall be securely held in a fixed position relative to the pilot. For manufactured gas, the need for a flame arrester in the bleed line piping shall be determined.

**508.24.5** Bleed lines from a diaphragm-type valve and vent lines from a gas appliance pressure regulator shall not be connected to a common manifold terminating in a combustion chamber. Bleed lines shall not terminate in positive-pressure-type combustion chambers. [NFPA 54: 8.1.20]

**508.25 Combination of Equipment.** Any combination of gas utilization equipment, attachments, or devices used together in any manner shall comply with the standards that apply to the individual equipment. [NFPA 54: 8.1.21]

**508.26 Installation Instructions.** The installing agency shall conform with the equipment manufacturers' recommendations in completing an installation. The installing agency shall leave the manufacturers' installation, operating, and maintenance instructions in a location on the premises where they will be readily available for reference and guidance of the Authority Having Jurisdiction, service personnel, and the owner or operator. [NFPA 54: 8.1.22]

**508.27 Protection of Outdoor Equipment.** Gas utilization equipment not listed for outdoor installation but installed outdoors shall be provided with protection to the degree that the environment requires. Equipment listed for outdoor installation shall be permitted to be installed without protection in accordance with the provisions of their listing. (See 8.2.1.) [NFPA 54: 8.1.23]

*(The following references were extracted from NFPA 54.)*

*8.2 Accessibility and Clearance.*

*8.2.1 Accessibility for Service.* All gas utilization equipment shall be located with respect to building construction and other equipment so as to permit access to the gas utilization equipment. Sufficient clearance shall be maintained to permit cleaning of heating surfaces; the replacement of filters, blowers, motors, burners, controls, and vent

*connections; the lubrication of moving parts where necessary; the adjustment and cleaning of burners and pilots; and the proper functioning of explosion vents, if provided. For attic installation, the passageway and servicing area adjacent to the equipment shall be floored.*

## **509.0 Equipment on Roofs.**

### **509.1 General.**

- (1) Gas-utilization equipment on roofs shall be designed or enclosed so as to withstand climactic conditions in the area in which they are installed. Where enclosures are provided, each enclosure shall permit easy entry and movement, shall be of reasonable height, and shall have at least a 30 in. (760 mm) clearance between the entire service access panel(s) of the equipment and the wall of the enclosure.
- (2) Roofs on which equipment is to be installed shall be capable of supporting the additional load or shall be reinforced to support the additional load.
- (3) All access locks, screws, and bolts shall be of corrosion-resistant material. [NFPA 54: 8.4.1]

### **509.2 Installation of Equipment on Roofs.**

- (1) Gas utilization equipment shall be installed in accordance with its listing and the manufacturer's installation instructions.
- (2) Equipment shall be installed on a well-drained surface of the roof. At least 6 ft (1.8m) of clearance shall be available between any part of the equipment and the edge of a roof or similar hazard or rigidly fixed rails, guards, parapets, or other building structures at least 42 in. (1.1 m) in height shall be provided on the exposed side.
- (3) All equipment requiring an external source of electrical power for its operation shall be provided with (1) a readily accessible electrical disconnecting means within sight of the equipment that will completely deenergize the equipment, and (2) a 120-V ac grounding-type receptacle outlet on the roof adjacent to the equipment. The receptacle outlet shall be on the supply side of the disconnect switch.
- (4) Where water stands on the roof at the equipment or in the passageways to the equipment, or where the roof is of a design having a water seal, a suitable platform, walkway, or both shall be provided above the water line. Such platforms or walkways shall be located adjacent to the equipment and

control panels so that the equipment can be safely serviced where water stands on the roof. [NFPA 54: 8.4.2]

### 509.3 Access to Equipment on Roofs.

**509.3.1** Gas utilization equipment located on roofs or other elevated locations shall be accessible.

**509.3.2** Buildings more than 15 ft (4.6 m) in height shall have an inside means of access to the roof, unless other means acceptable to the Authority Having Jurisdiction are used.

**509.3.3** The inside means of access shall be a permanent, or fold-away inside stairway or ladder, terminating in an enclosure, scuttle, or trap door. Such scuttles or trap doors shall be at least 22 in. x 24 in. (560 mm x 610 mm) in size, shall open easily and safely under all conditions, especially snow, and shall be constructed so as to permit access from the roof side unless deliberately locked on the inside.

At least 6 ft (1.8 m) of clearance shall be available between the access opening and the edge of the roof or similar hazard, or rigidly fixed rails or guards a minimum of 42 in. (1.1 m) in height shall be provided on the exposed side. Where parapets or other building structures are utilized in lieu of guards or rails, they shall be a minimum of 42 in. (1.1 m) in height.

**509.3.4** Permanent lighting shall be provided at the roof access. The switch for such lighting shall be located inside the building near the access means leading to the roof. [NFPA 54: 8.4.3]

### 510.0 Venting of Equipment.

**510.1 General.** This section recognizes that the choice of venting materials and the methods of installation of venting systems are dependent on the operating characteristics of the gas utilization equipment. The operating characteristics of vented gas utilization equipment can be categorized with respect to (1) positive or negative pressure within the venting system and (2) whether or not the equipment generates flue or vent gases that can condense in the venting system. See Section 3.3 for the definition of these vented appliance categories. [NFPA 54:10.1]

### 510.2 Specification for Venting.

#### 510.2.1 Connection to Venting Systems.

Except as permitted in 510.2.2 through 510.2.6, all gas utilization equipment shall be connected to venting systems.

**510.2.2 Equipment Not Required to Be Vented.** The following equipment shall not be required to be vented:

**510.2.2.1** Listed Ranges.

**510.2.2.2** Built-in Domestic Cooking Units Listed and Marked for Optional Venting.

**510.2.2.3** Listed Hot Plates and Listed Laundry Stoves.

**510.2.2.4** Listed Type 1 clothes dryers shall be exhausted to the outside air. [NFPA 54:9.4]

**510.2.2.5** A single listed booster-type (automatic instantaneous) water heater, when designed and used solely for the sanitizing rinse requirements of a dishwashing machine, provided that the equipment is installed with the draft hood in place and unaltered if a draft hood is required, in a commercial kitchen having a mechanical exhaust system; where installed in this manner, the draft hood outlet shall not be less than 36 in. (910 mm) vertically and 6 in. (150 mm) horizontally from any surface other than the equipment.

**510.2.2.6** Listed Refrigerators.

**510.2.2.7** Counter appliances.

**510.2.2.8 RESERVED**

**510.2.2.9** Direct Gas-Fired Makeup Air Heaters.

**510.2.2.10** Other Equipment Listed for Unvented Use and Not Provided with Flue Collars.

**510.2.2.11** Specialized Equipment of Limited Input such as Laboratory Burners or Gas Lights. Where any or all of this equipment in 510.2.2.5 through 510.2.2.11 is installed so the aggregate input rating exceeds 20 Btu/h/ft<sup>3</sup> (207 W/m<sup>3</sup>) of room or space in which it is installed, one or more shall be provided with venting systems or other approved means for removing the vent gases to the outside atmosphere so the aggregate input rating of the remaining unvented equipment does not exceed 20 Btu/h/ft<sup>3</sup> (207 W/m<sup>3</sup>). Where the calculation includes the volume of an adjacent room or space, the room or space in which the equipment is installed shall be directly connected to the adjacent room or space by a doorway, archway, or other opening of comparable size that cannot be closed.

**510.2.3 Ventilating Hoods.** Ventilating hoods and exhaust systems shall be permitted to be used to vent gas utilization equipment installed in commercial applications (see 510.3.5) and to vent industrial equipment, particularly where the process itself requires fume disposal. [NFPA 54:10.2.3]

**510.2.4 Well-Ventilated Spaces.** The operation of industrial gas utilization equipment such that its flue gases are discharged directly into a large and well-ventilated space shall be permitted.

**510.2.5 Direct-Vent Equipment.** Listed direct-vent gas utilization equipment shall be considered properly vented where installed in accordance with the terms of its listing, the manufacturers' instructions, and section 510.8(3) of this code.

**510.2.6 Equipment with Integral Vents.** Gas utilization equipment incorporating integral venting means shall be considered properly vented where installed in accordance with its listing, the manufacturers' instructions, and Sections 510.8(1) and (2) of this code. [NFPA 54:10.2.6]

### 510.3 Design and Construction.

**510.3.1 Minimum Safe Performance.** A venting system shall be designed and constructed so as to develop a positive flow adequate to remove flue or vent gases to the outside atmosphere.

**510.3.2 Equipment Draft Requirements.** A venting system shall satisfy the draft requirements of the equipment in accordance with the manufacturer's instructions.

**510.3.3 Design and Construction.** Gas utilization equipment required to be vented shall be connected to a venting system designed and installed in accordance with the provisions of Sections 510.4 through 510.15 of this code.

#### 510.3.4 Mechanical Draft Systems.

**510.3.4.1** Mechanical draft systems shall be listed and shall be installed in accordance with the terms of their listing and both the appliance and the mechanical draft system manufacturers' instructions.

**510.3.4.2** Gas utilization equipment requiring venting shall be permitted to be vented by means of mechanical draft systems of either forced or induced draft design.

**Exception:** Incinerators.

**510.3.4.3** Forced draft systems and all portions of induced draft systems under positive pressure during operation shall be designed and installed so as to prevent leakage of flue or vent gases into a building.

**510.3.4.4** Vent connectors serving equipment vented by natural draft shall not be connected into any portion of mechanical draft systems operating under positive pressure.

**510.3.4.5** Where a mechanical draft system

is employed, provision shall be made to prevent the flow of gas to the main burners when the draft system is not performing so as to satisfy the operating requirements of the equipment for safe performance.

**510.3.4.6** The exit terminals of mechanical draft systems shall be not less than 7 ft (2.1 m) above grade where located adjacent to public walkways and shall be located as specified in Sections 510.8(1) and (2) of this code.

#### 510.3.5 Ventilating Hoods and Exhaust Systems.

**510.3.5.1** Ventilating hoods and exhaust systems shall be permitted to be used to vent gas utilization equipment installed in commercial applications.

**510.3.5.2** Where automatically operated gas utilization equipment is vented through a ventilating hood or exhaust system equipped with a damper or with a power means of exhaust, provisions shall be made to allow the flow of gas to the main burners only when the damper is open to a position to properly vent the equipment and when the power means of exhaust is in operation.

**510.3.6 Circulating Air Ducts and Furnace Plenums.** No portion of a venting system shall extend into or pass through any circulating air duct or furnace plenum. [NFPA 54:10.3.6]

#### 510.4 Type of Venting System to Be Used.

**510.4.1** The type of venting system to be used shall be in accordance with Table 5-3.

**510.4.2 Plastic Piping.** Plastic piping used for venting equipment listed for use with such venting materials shall be approved.

**510.4.3 Special Gas Vent.** Special gas vent shall be listed and installed in accordance with the terms of the special gas vent listing and the manufacturers' instructions. [NFPA 54:10.4.3]

#### 510.5 Masonry, Metal, and Factory-Built Chimneys.

##### 510.5.1 Listing or Construction.

**510.5.1.1** Factory-built chimneys shall be installed in accordance with their listing and the manufacturers' instructions. Factory-built chimneys used to vent appliances that operate at positive vent pressure shall be listed for such application.

**510.5.1.2** Metal chimneys shall be built and installed in accordance with NFPA 211, *Standard for Chimneys, Fireplaces, Vents, and Solid Fuel-Burning Appliances*.

**510.5.1.3** Masonry chimneys shall be built and installed in accordance with NFPA 211, *Standard for Chimneys, Fireplaces, Vents, and Solid Fuel-Burning Appliances*, and lined with approved clay flue lining, a listed chimney lining system, or other approved material that will resist corrosion, erosion, softening, or cracking from vent gases at temperatures up to 1800°F (982°C).

**Exception:** Masonry chimney flues lined with a chimney lining system specifically listed for use with listed gas appliances with draft hoods, Category I appliances, and other gas appliances listed for use with Type B vents shall be permitted. The liner shall be installed in accordance with the liner manufacturer's instructions and the terms of the listing. A permanent identifying label shall be attached at the point where the connection is to be made to the liner. The label shall read: "This chimney liner is for appliances that burn gas only. Do not connect to solid or liquid-fuel-burning appliances or incinerators."

#### 510.5.2 Termination.

**510.5.2.1** A chimney for residential-type or low-heat gas utilization equipment shall extend at least 3 ft (0.9 m) above the highest point where it passes through a roof of a building and at least 2 ft (0.6 m) higher than any portion of a building within a horizontal distance of 10 ft (3.0 m). [See Figure 5-1.]

**510.5.2.2** A chimney for medium-heat equipment shall extend at least 10 ft (3.0 m) higher than any portion of any building within 25 ft (7.6 m).

**510.5.2.3** A chimney shall extend at least 5 ft (1.5 m) above the highest connected equipment draft hood outlet or flue collar.

**510.5.2.4** Decorative shrouds shall not be installed at the termination of factory-built chimneys except where such shrouds are listed and labeled for use with the specific factory-built chimney system and are installed in accordance with manufacturers' installation instructions.

**510.5.3 Size of Chimneys.** The effective area of a chimney venting system serving listed gas appliances with draft hoods, Category I appliances, and other appliances listed for use with Type B vents shall be in accordance with one of the following methods:

- (1) This chapter and NFPA 54: Chapter 13.
- (2) For sizing an individual chimney venting system for a single appliance with a draft

hood, the effective areas of the vent connector and chimney flue shall be not less than the area of the appliance flue collar or draft hood outlet or greater than seven times the draft hood outlet area.

- (3) For sizing a chimney venting system connected to two appliances with draft hoods, the effective area of the chimney flue shall be not less than the area of the larger draft hood outlet plus 50 percent of the area of the smaller draft hood outlet, or greater than seven times the smallest draft hood outlet area.
- (4) Other approved engineering methods.
- (5) Chimney venting systems using mechanical draft shall be sized in accordance with approved engineering methods. Where an incinerator is vented by a chimney serving other gas utilization equipment, the gas input to the incinerator shall not be included in calculating chimney size, provided the chimney flue diameter is not less than 1 in. (25 mm) larger in equivalent diameter than the diameter of the incinerator flue outlet.

#### 510.5.4 Inspection of Chimneys.

- (A) Before replacing an existing appliance or connecting a vent connector to a chimney, the chimney passageway shall be examined to ascertain that it is clear and free of obstructions and shall be cleaned if previously used for venting solid- or liquid-fuel-burning appliances or fireplaces.
- (B) Chimneys shall be lined in accordance with NFPA 211, *Standard for Chimneys, Fireplaces, Vents, and Solid-Fuel Burning Appliances*.
- (C) Cleanouts shall be examined to determine that they will remain tightly closed when not in use.
- (D) When inspection reveals that an existing chimney is not safe for the intended application, it shall be repaired, rebuilt, lined, relined, or replaced with a vent or chimney to conform to NFPA 211, *Standard for Chimneys, Fireplaces, Vents, and Solid-Fuel-Burning Appliances*, and shall be suitable for the equipment to be attached.

#### 510.5.5 Chimney Serving Equipment Burning Other Fuels.

**510.5.5.1** Gas utilization equipment shall not be connected to a chimney flue serving a separate appliance designed to burn solid fuel.

**510.5.5.2** Where one chimney serves gas utilization equipment and equipment burning liquid fuel, the equipment shall be connected through separate openings or shall be connected through a single opening

where joined by a suitable fitting located as close as practical to the chimney. Where two or more openings are provided into one chimney flue, they shall be at different levels. Where the gas utilization equipment is automatically controlled, it shall be equipped with a safety shutoff device.

**TABLE 5-3**  
**Type of Venting System to Be Used**

Gas Utilization Equipment	Type of Venting System
Listed Category I equipment	Type B gas vent (510.6)
Listed equipment equipped with draft hood	Chimney (510.5)
Equipment listed for use with Type B gas vent system for gas venting	Single-wall metal pipe (510.7)
	Listed chimney lining (510.5.1.3)
	Special gas vent listed for this equipment (510.4.3)
Listed vented wall furnaces	Type B-W gas vent (510.6, NFPA 54:9.27)
Category II equipment	As specified or furnished
Category III equipment	by manufacturers of listed
Category IV equipment	equipment (510.4.2, 510.4.3)
Incinerators, outdoors	Single-wall metal pipe (510.7, 510.7.3.3)
Incinerators, indoors	Chimney (510.5)
Equipment that can be converted to use of solid fuel	
Unlisted combination gas- and oil-burning equipment	
Combination gas- and solid-fuel-burning equipment	
Equipment listed for use with chimneys only	
Unlisted equipment	
Listed combination gas- and oil-burning equipment	Type L vent (510.6) or chimney (510.5)
Decorative appliance in vented fireplace	Chimney (907.2.3)
Gas-fired toilets	Single-wall metal pipe (510.7, NFPA 54: 9.25.3)
Direct-vent equipment	See 510.2.5
Equipment with integral vent	See 510.2.6

[NFPA 54: Table 10.4.1]

**510.5.5.3** A listed combination gas- and solid-fuel-burning appliance connected to a

single chimney flue shall be equipped with a manual reset device to shut off gas to the main burner in the event of sustained backdraft or flue gas spillage. The chimney flue shall be sized to properly vent the appliance.

**510.5.5.4** A single chimney flue serving a listed combination gas- and oil-burning appliance shall be sized to properly vent the appliance.

**510.5.6 Support of Chimneys.** All portions of chimneys shall be supported for the design and weight of the materials employed. Listed factory-built chimneys shall be supported and spaced in accordance with their listings and the manufacturers' instructions.

**510.5.7 Cleanouts.** Where a chimney that formerly carried flue products from liquid- or solid-fuel-burning appliances is used with an appliance using fuel gas, an accessible cleanout shall be provided. The cleanout shall have a tight-fitting cover and be installed so its upper edge is at least 6 in. (150 mm) below the lower edge of the lowest chimney inlet opening.

**510.5.8 Space Surrounding Lining or Vent.**

**510.5.8.1** The remaining space surrounding a chimney liner, gas vent, special gas vent, or plastic piping installed within a masonry chimney flue shall not be used to vent another appliance.

**Exception:** The insertion of another liner or vent within the chimney as provided in this code and the liner or vent manufacturer's instructions.

**510.5.8.2** The remaining space surrounding a chimney liner, gas vent, special gas vent, or plastic piping installed within a masonry chimney flue shall not be used to supply combustion air. [NFPA 54: 10.5.8.2]

**Exception:** Direct-vent gas-fired appliances designed for installation in a solid-fuel-burning fireplace where installed in accordance with the listing and the manufacturer's instruction.

**510.6 Gas Vents.**

**510.6.1 Application.** The installation of gas vents shall comply with the following requirements:

**510.6.1.1** Gas vents shall be installed in accordance with the terms of their listings and the manufacturers' instructions.

**510.6.1.2** A Type B-W gas vent shall have a listed capacity not less than that of the listed vented wall furnace to which it is connected.

**510.6.1.3** A gas vent passing through a roof

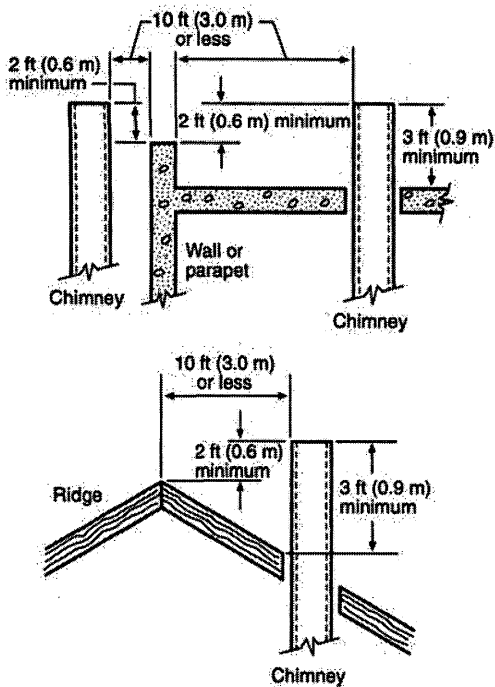

(a) Termination 10 ft (3.0 m) or Less from Ridge, Wall, or Parapet

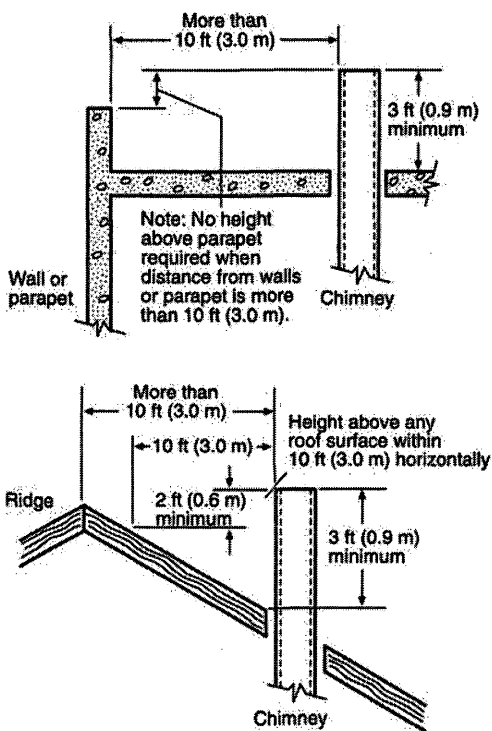

(b) Termination More Than 10 ft (3.0 m) from Ridge, Wall, or Parapet

**FIGURE 5-1 Typical Termination Locations for Chimneys and Single-Wall Metal Pipes Serving Residential-Type and Low-Heat Equipment [NFPA 54:Figure 10.5.2.1]**

shall extend through the entire roof flashing, roof jack, or roof thimble and be terminated with a listed termination cap.

**510.6.1.4** Type B or Type L vents shall extend in a generally vertical direction with offsets not exceeding 45 degrees, except that a vent system having not more than one 60 degree offset shall be permitted. Any angle greater than 45 degrees from the vertical is considered horizontal. The total horizontal distance of a vent plus the horizontal vent connector serving draft-hood-equipped appliances shall not be greater than 75 percent of the vertical height of the vent.

**Exception:** Systems designed and sized as provided in this chapter or in accordance with other approved engineering methods.

**510.6.1.5** Vents serving Category I fan-assisted appliances shall be installed in accordance with the appliance manufacturer's instructions and NFPA 54 Chapter 10 or other approved engineering methods.

**510.6.1.6** Gas vents installed within masonry chimneys shall be installed in accordance with the terms of their listing and the manufacturers' installation instructions. Gas vents installed within masonry chimneys shall be identified with a permanent label installed at the point where the vent enters the chimney. The label shall contain the following language: "This gas vent is for appliances that burn gas. Do not connect to solid- or liquid-fuel-burning appliances or incinerators."

**510.6.2 Gas Vent Termination.** The termination of gas vents shall comply with the following requirements:

**510.6.2.1** A gas vent shall terminate in accordance with one of the following:

- (1) Above the roof surface with a listed cap or listed roof assembly. Gas vents 12 in. (300 mm) in size or smaller with listed caps shall be permitted to be terminated in accordance with Figure 5-2, provided they are at least 8 ft (2.4 m) from a vertical wall or similar obstruction. All other gas vents shall terminate not less than 2 ft (0.6 m) above the highest point where they pass through the roof and at least 2 ft (0.6 m) higher than any portion of a building within 10 ft (3.1 m).
- (2) Industrial gas utilization equipment as provided in Section 510.2.4.



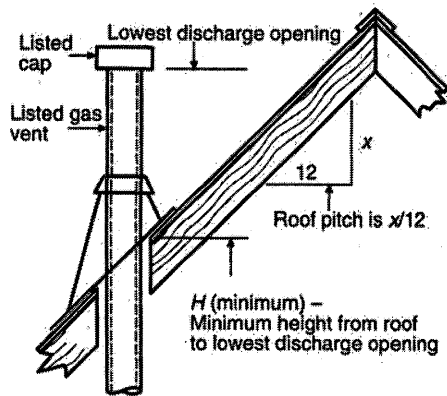

**Roof pitch heights**

Roof pitch	H(minimum) ft	m
Flat to 6/12	1.0	0.30
6/12 to 7/12	1.25	0.38
Over 7/12 to 8/12	1.5	0.46
Over 8/12 to 9/12	2.0	0.61
Over 9/12 to 10/12	2.5	0.76
Over 10/12 to 11/12	3.25	0.99
Over 11/12 to 12/12	4.0	1.22
Over 12/12 to 14/12	5.0	1.52
Over 14/12 to 16/12	6.0	1.83
Over 16/12 to 18/12	7.0	2.13
Over 18/12 to 20/12	7.5	2.27
Over 20/12 to 21/12	8.0	2.44

**FIGURE 5-2 Gas Vent Termination Locations for Listed Caps 12 in. (300 mm) or Less in Size at Least 8 ft (2.4 m) from a Vertical Wall [NFPA 54: Figure 10.6.2]**

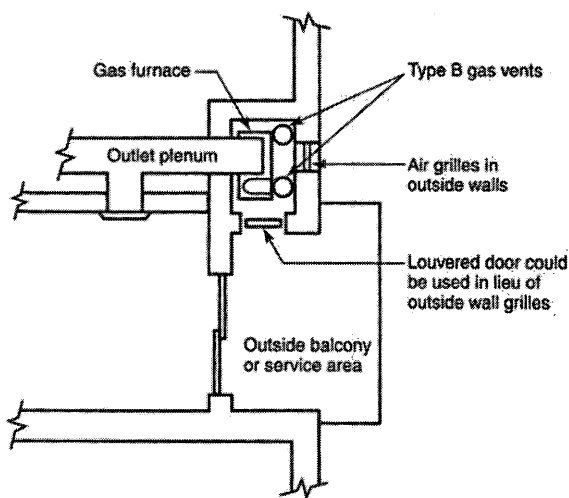

**FIGURE 5-3 Plan View of Practical Separation Method for Multistory Gas Venting. [NFPA 54: Figure 10.6.4.2]**

- (3) Direct-vent systems as provided in Section 510.2.5.
- (4) Equipment with integral vents as provided in Section 510.2.6.
- (5) Mechanical draft systems as provided in Section 510.3.4.
- (6) Ventilating hoods and exhaust systems as provided in Section 510.3.5.

**510.6.2.2** A Type B or a Type L gas vent shall terminate at least 5 ft (1.5 m) in vertical height above the highest connected equipment draft hood or flue collar.

**510.6.2.3** A Type B-W gas vent shall terminate at least 12 ft (3.7 m) in vertical height above the bottom of the wall furnace.

**510.6.2.4** A gas vent extending through an exterior wall shall not terminate adjacent to the wall or below eaves or parapets, except as provided in Sections 510.2.5 and 510.3.4.

**510.6.2.5** Decorative shrouds shall not be installed at the termination of gas vents except where such shrouds are listed for use with the specific gas venting system and are installed in accordance with manufacturers' installation instructions.

**510.6.3 Size of Gas Vents.** Venting systems shall be sized and constructed in accordance with NFPA 54 Chapter 10 or other approved engineering methods and the gas vent and gas equipment manufacturers' instructions.

**510.6.3.1 Category I Appliances.** The sizing of natural draft venting systems serving one or more listed venting systems equipped with a draft hood or appliances listed for use with Type B gas vent, installed in a single story of a building, shall be in accordance with one of the following methods.

- (1) The provisions of this chapter.
- (2) Vents serving fan-assisted combustion system appliances, or combinations of fan-assisted combustion system and draft-hood-equipped appliances shall be sized in accordance with this chapter or other approved engineering methods.
- (3) For sizing an individual gas vent for a single, draft-hood-equipped appliance, the effective area of the vent connector and the gas vent shall be not less than the area of the appliance draft hood outlet or greater than seven times the draft hood outlet area.

- (4) For sizing a gas vent connected to two appliances with draft hoods, the effective area of the vent shall be not less than the area of the larger draft hood outlet plus 50 percent of the area of the smaller draft hood outlet or greater than seven times the smaller draft hood outlet area.
- (5) Approved engineering practices.

**510.6.3.2 Category II, Category III, and Category IV Appliances.** The sizing of gas vents for Category II, Category III, and Category IV gas utilization equipment shall be in accordance with the equipment manufacturers' instructions.

**510.6.3.3 Sizing.** Chimney venting systems using mechanical draft shall be sized in accordance with approved engineering methods.

**510.6.4 Gas Vents Serving Equipment on More Than One Floor.** A single or common gas vent shall be permitted in multistory installations to vent Category I gas utilization equipment located on more than one floor level, provided the venting system is designed and installed in accordance with approved engineering methods.

All gas utilization equipment connected to the common vent shall be located in rooms separated from habitable space. Each of these rooms shall have provisions for an adequate supply of combustion, ventilation, and dilution air that is not supplied from habitable space. (See Figure 5-3.)

The size of the connectors and common segments of multistory venting systems for gas utilization equipment listed for use with Type B double-wall gas vent shall be in accordance with Table 5-14, provided:

- (1) The available total height (H) for each segment of a multistory venting system is the vertical distance between the level of the highest draft hood outlet or flue collar on that floor and the centerline of the next highest interconnection tee. (See Figure G.1(K).)
- (2) The size of the connector for a segment is determined from its gas utilization equipment heat input and available connector rise, and shall not be smaller than the draft hood outlet or flue collar size.
- (3) The size of the common vertical vent segment, and of the interconnection tee at the base of that segment, shall be based on the total gas utilization equipment heat input entering that segment and its available total height.

**510.6.5 Support of Gas Vents.** Gas vents shall be supported and spaced in accordance with their listings and the manufacturers' instructions.

**510.6.6 Marking.** In those localities where solid and liquid fuels are used extensively, gas vents shall be permanently identified by a label attached to the wall or ceiling at a point where the vent connector enters the gas vent. The label shall read: "This gas vent is for appliances that burn gas. Do not connect to solid- or liquid-fuel-burning appliances or incinerators." The Authority Having Jurisdiction shall determine whether its area constitutes such a locality. [NFPA 54:10.6.6]

**Figure 5-4 RESERVED**

### 510.7 Single-Wall Metal Pipe.

**510.7.1 Construction.** Single-wall metal pipe shall be constructed of galvanized sheet steel not less than 0.0304 in. (0.7 mm) thick or of other approved, noncombustible, corrosion-resistant material.

**510.7.2 Cold Climate.** Uninsulated single-wall metal pipe shall not be used outdoors in cold climates for venting gas utilization equipment.

**510.7.3 Termination.** The termination of single-wall metal pipe shall comply with the following requirements:

- 510.7.3.1** Single-wall metal pipe shall terminate at least 5 ft (1.5 m) in vertical height above the highest connected equipment draft hood outlet or flue collar.
- 510.7.3.2** Single-wall metal pipe shall extend at least 2 ft (0.6 m) above the highest point where it passes through the roof of a building and at least 2 ft (0.6 m) higher than any portion of a building within a horizontal distance of 10 ft (3.1 m). [See Figure 5-1.]

**510.7.3.3** An approved cap or roof assembly shall be attached to the terminus of a single-wall metal pipe. [Also see 510.7.4.3.]

### 510.7.4 Installation with Equipment Permitted by 510.4.1.

**510.7.4.1** Single-wall metal pipe shall be used only for runs directly from the space in which the gas utilization equipment is located through the roof or exterior wall to the outer air. A pipe passing through a roof shall extend without interruption through the roof flashing, roof jacket, or roof thimble.

**510.7.4.2** Single-wall metal pipe shall not originate in any unoccupied attic or

concealed space and shall not pass through any attic, inside wall, concealed space, or floor. [For the installation of a single-wall metal pipe through an exterior combustible wall, see 510.10.14.2.]

**510.7.4.3** Single-wall metal pipe used for venting an incinerator shall be exposed and readily examinable for its full length and shall have suitable clearances maintained.

**510.7.4.4** Minimum clearances from single-wall metal pipe to combustible material shall be in accordance with Table 5-4. Reduced clearances from single-wall metal pipe to combustible material shall be as specified for vent connectors in Table 5-5.

**510.7.4.5** Where a single-wall metal pipe passes through a roof constructed of combustible material, a noncombustible, nonventilating thimble shall be used at the point of passage. The thimble shall extend at least 18 in. (460 mm) above and 6 in. (150 mm) below the roof with the annular space

open at the bottom and closed only at the top. The thimble shall be sized in accordance with 510.10.14(2).

**510.7.5 Size of Single-Wall Metal Pipe.** Single-wall metal piping shall comply with the following requirements:

**510.7.5.1** A venting system of a single-wall metal pipe shall be sized in accordance with one of the following methods and the gas equipment manufacturer's instructions:

- (1) For a draft-hood-equipped appliance, in accordance with this chapter.
- (2) For a venting system for a single appliance with a draft hood, the areas of the connector and the pipe each shall not be less than the area of the appliance flue collar or draft hood outlet, whichever is smaller. The vent area shall not be greater than seven times the draft hood outlet area.
- (3) Other approved engineering methods.

**510.7.5.2** Where a single-wall metal pipe is

**TABLE 5-4**  
**Clearance for Connectors [NFPA 54: Table 10.7.4.4]**

Equipment	Minimum Distance from Combustible Material			
	Listed Type B Gas Vent Material	Listed Type L Vent Material	Single-Wall Metal Pipe	Factory-Built Chimney Sections
Listed equipment with draft hoods and equipment listed for use with Type B gas vents	As listed	As listed	6 in.	As listed
Residential boilers and furnaces with listed gas conversion burner and with draft hood	6 in.	6 in.	9 in.	As listed
Residential appliances listed for use with Type L vents	Not permitted	As listed	9 in.	As listed
Residential incinerators	Not permitted	9 in.	18 in.	As listed
Listed gas-fired toilets	Not permitted	As listed	As listed	As listed
Unlisted residential appliances with draft hood	Not permitted	6 in.	9 in.	As listed
Residential and low-heat equipment other than those above	Not permitted	9 in.	18 in.	As listed
Medium-heat equipment	Not permitted	Not permitted	36 in.	As listed

For SI units, 1 in. = 25.4 mm.

Note: These clearances shall apply unless the listing of an appliance or connector specifies clearances, in which case the listed clearances shall apply.

used and has a shape other than round, it shall have an equivalent effective area equal to the effective area of the round pipe for which it is substituted, and the minimum internal dimension of the pipe shall be 2 in. (50 mm).

**510.7.5.3** The vent cap or a roof assembly shall have a venting capacity not less than that of the pipe to which it is attached.

**510.7.6 Support of Single-Wall Metal Pipe.**

All portions of single-wall metal pipe shall be supported for the design and weight of the material employed.

**510.7.7 Marking.** Single-wall metal pipe shall comply with the marking provisions of 510.6.6. [NFPA 54:10.7.7]

**510.8 Through-the-Wall Vent Termination.** (See Figure 5-13)

**510.8.1** A mechanical draft venting system shall terminate at least 3 ft (0.9 m) above any forced air inlet located within 10 ft (3.1 m).

**Exception No. 1:** This provision shall not apply to the combustion air intake of a direct-vent appliance.

**Exception No. 2:** This provision shall not apply to the separation of the integral outdoor air inlet and flue gas discharge of listed outdoor appliances.

**510.8.2** A mechanical draft venting system of other than direct-vent type shall terminate at least 4 ft (1.2 m) below, 4 ft (1.2 m) horizontally from, or 1 ft (300 mm) above any door, operable window, or gravity air inlet into any building. The bottom of the vent terminal shall be located at least 12 in. (300 mm) above grade.

**510.8.3** The vent terminal of a direct-vent appliance with an input of 10,000 Btu/h (3 kW) or less shall be located at least 6 in. (150 mm) from any air opening into a building, and such an appliance with an input over 10,000 Btu/h (3 kW) but not over 50,000 Btu/h (14.7 kW) shall be installed with a 9-in. (230-mm) vent termination clearance, and an appliance with an input over 50,000 Btu/h (14.7 kW) shall have at least a 12 in. (300-mm) vent termination clearance. The bottom of the vent terminal and the air intake shall be located at least 12 in. (300 mm) above grade.

**510.8.4** Through-the-wall vents for Category II and Category IV appliances and noncategorized condensing appliances shall not terminate over public walkways or over an area where condensate or vapor could create a nuisance of hazard or could be detrimental to the operation

of regulators, relief valves, or other equipment. Where local experience indicates that condensate is a problem with Category I and Category III appliances, this provision shall also apply. [NFPA 54:10.8.4]

**510.9 Condensation Drain.**

**510.9.1** Provision shall be made to collect and dispose of condensate from venting systems serving Category II and Category IV gas utilization equipment and noncategorized condensing appliances in accordance with 510.8.4.

**510.9.2** Where local experience indicates that condensation is a problem, provision shall be made to drain off and dispose of condensate from venting systems serving Category I and Category III gas utilization equipment in accordance with 510.8.4. [NFPA 54:10.9.2]

**510.10 Vent Connectors for Category I Gas Utilization Equipment.**

**510.10.1 Where Required.** A vent connector shall be used to connect gas utilization equipment to a gas vent, chimney, or single-wall metal pipe, except where the gas vent, chimney, or single-wall metal pipe is directly connected to the equipment.

**510.10.2 Materials.**

**510.10.2.1** A vent connector shall be made of noncombustible, corrosion-resistant material capable of withstanding the vent gas temperature produced by the gas utilization equipment and of sufficient thickness to withstand physical damage.

**510.10.2.2** Where the vent connector used for gas utilization equipment having a draft hood or a Category I appliance is located in or passes through an unconditioned area, that portion of the vent connector shall be listed Type B, Type L or listed vent material having equivalent insulation qualities.

**Exception:** Single-wall metal pipe located within the exterior walls of the building and located in areas having a local 99 percent winter design temperature of 5°F or higher.

**510.10.2.3** Where the vent connector used for gas utilization equipment having a draft hood or a Category I appliance is located in or passes through attics and crawl spaces, that portion of the vent connector shall be listed Type B, Type L or listed vent material having equivalent insulation qualities.

**510.10.2.4** Vent connectors for residential-

**Table 5-5  
Reduction of Clearances with Specified Forms of Protection**

Where the required clearance with no protection from appliance, vent connector, or single-wall metal pipe is:										
	36 in.		18 in.		12 in.		9 in.		6 in.	
Allowable Clearances with Specified Protection (in.)										
Type of protection applied to and covering all surfaces of combustible material within the distance specified as the required clearance with no protection [See Figure 5-5 through Figure 5-7.]	Use Col. 1 for clearances above appliance or horizontal connector. Use Col. 2 for clearances from appliances, vertical connector, and single-wall metal pipe.									
	Above Col. 1	Sides and Rear Col. 2	Above Col. 1	Sides and Rear Col. 2	Above Col. 1	Sides and Rear Col. 2	Above Col. 1	Sides and Rear Col. 2	Above Col. 1	Sides and Rear Col. 2
(1) 3-1/2 in. thick masonry wall without ventilated air space	--	24	--	12	--	9	--	6	--	5
(2) 1/2 in. insulation board over 1 in. glass fiber or mineral wool batts	24	18	12	9	9	6	6	5	4	3
(3) 0.024 sheet metal over 1 in. glass fiber or mineral wool batts reinforced with wire on rear face with ventilated air space	18	12	9	6	6	4	5	3	3	3
(4) 3-1/2 in. thick masonry wall with ventilated air space	--	12	--	6	--	6	--	6	--	6
(5) 0.024 sheet metal with ventilated air space	18	12	9	6	6	4	5	3	3	2
(6) 1/2 in. thick insulation board with ventilated air space	18	12	9	6	6	4	5	3	3	3
(7) 0.024 sheet metal with ventilated air space over 0.024 sheet metal with ventilated air space	18	12	9	6	6	4	5	3	3	3
(8) 1 in. glass fiber or mineral wool batts sandwiched between two sheets 0.024 sheet metal with ventilated air space	18	12	9	6	6	4	5	3	3	3

For SI units, 1 in. = 25.4 mm.

Notes:

- Reduction of clearances from combustible materials shall not interfere with combustion air, draft hood clearance and relief, and accessibility of servicing.
- All clearances shall be measured from the outer surface of the combustible material to the nearest point on the surface of the appliance, disregarding any intervening protection applied to the combustible material.
- Spacers and ties shall be of noncombustible material. No spacer or tie shall be used directly opposite the appliance or connector.
- Where all clearance reduction systems use a ventilated air space, adequate provision for air circulation shall be provided as described. [See Figure 5-6 and Figure 5-7]
- There shall be at least 1 in. (25 mm) between clearance reduction systems and combustible walls and ceilings for reduction systems using a ventilated air space.
- Where a wall protector is mounted on a single flat wall away from corners, it shall have a minimum 1 in. (25 mm) air gap. To provide adequate air circulation, the bottom and top edges, or only the side and top edges, or all edges shall be left open.
- Mineral wool batts (blanket or board) shall have a minimum density of 8 lb/ft<sup>3</sup> (128 kg/m<sup>3</sup>) and a minimum melting point of 1500°F (816°C).
- Insulation material used as part of a clearance reduction system shall have a thermal conductivity of 1.0 Btu in./ft<sup>2</sup>/h-°F (0.144 W/m-K) or less.
- There shall be at least 1 in. (25 mm) between the appliance and the protector. In no case shall the clearance between the appliance and the combustible surface be reduced below that allowed in this table.
- All clearances and thicknesses are minimum; larger clearances and thicknesses are acceptable.
- Listed single-wall connectors shall be installed in accordance with the terms of their listing and the manufacturer's instructions.

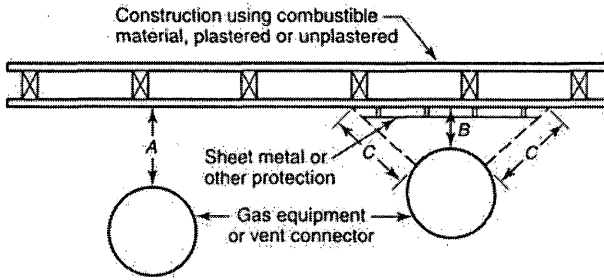

Notes:

A – equals the clearance with no protection specified in Tables 5-4 and 5-5 and in the sections applying to various types of equipment.

B – equals the reduced clearance permitted in accordance with Table 5-4. The protection applied to the construction using combustible material shall extend far enough in each direction to make C equal to A.

**FIGURE 5-5 Extent of Protection Necessary to Reduce Clearances from Gas Equipment or Vent Connectors.**

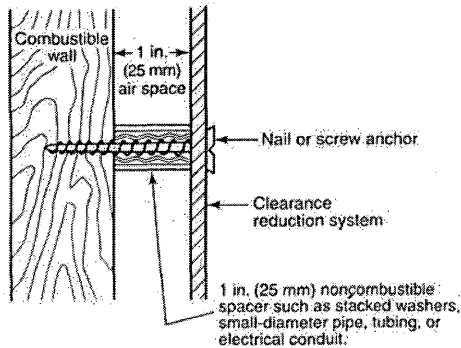
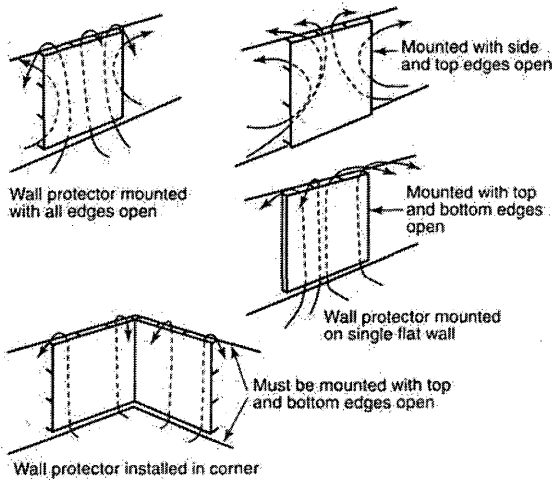

Masonry walls can be attached to combustible walls using wall ties. Spacers should not be used directly behind appliance or connector.

**FIGURE 5-6 Wall Protection Reduction System.**

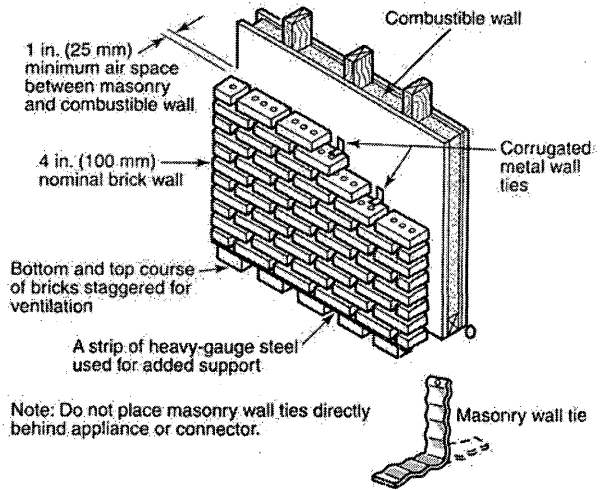

**FIGURE 5-7 Masonry Clearance Reduction System.**

**TABLE 5-6 Minimum Thickness for Galvanized Steel Vent Connector for Low-Heat Appliances**

Diameter of Connector (in.)	Minimum Thickness (in.)*
Less than 6	0.019
6 to less than 10	0.023
10 to 12 inclusive	0.029
14 to 16 inclusive	0.034
Over 16	0.056

\* For SI units, 1 in. = 25.4 mm; 1 in.<sup>2</sup> = 645 mm<sup>2</sup>.

type appliances shall comply with the following:

(1) Vent Connectors Not Installed in Attics, Crawl Spaces, or Other Unconditioned Areas. Vent connectors for listed gas appliances having draft hoods and for appliances having draft hoods and equipped with listed conversion burners that are not installed in attics, crawl spaces, or other unconditioned areas shall be one of the following:

- (a) Type B or Type L vent material
- (b) Galvanized sheet steel not less than 0.018 in. (0.46 mm) thick
- (c) Aluminum (1100 or 3003 alloy or equivalent) sheet not less than 0.027 in. (0.69 mm) thick

- (d) Stainless steel sheet not less than 0.012 in. (0.31 mm) thick
  - (e) Smooth interior wall metal pipe having resistance to heat and corrosion equal to or greater than that of b, c, or d above
  - (f) A listed vent connector
- (2) Vent connectors shall not be covered with insulation.

**Exception:** Listed insulated vent connectors shall be installed according to the terms of their listing.

**510.10.2.5** A vent connector for low-heat equipment shall be a factory-built chimney section or steel pipe having resistance to heat and corrosion equivalent to that for the appropriate galvanized pipe as specified in Table 5-6. Factory-built chimney sections shall be joined together in accordance with the chimney manufacturer's instructions.

**510.10.2.6** Vent connectors for medium-heat equipment and commercial and industrial incinerators shall be constructed of factory-built, medium-heat chimney sections or steel of a thickness not less than that specified in Table 5-7, and shall comply with the following:

- (1) A steel vent connector for equipment with a vent gas temperature in excess of 1000°F (538°C) measured at the entrance to the connector shall be lined with medium-duty fire brick (ASTM C 64, Specification for Refractories for Incinerators and Boilers, Type F) or the equivalent.
- (2) The lining shall be at least 2-1/2 in. (64 mm) thick for a vent connector having a diameter or greatest cross-sectional dimension of 18 in. (460 mm) or less.
- (3) The lining shall be at least 4-1/2 in. (110 mm) thick laid on the 4-1/2 in. (110-mm) bed for a vent connector having a diameter or greatest cross-sectional dimension greater than 18 in. (460 mm).
- (4) Factory-built chimney sections, if employed, shall be joined together in accordance with the chimney manufacturer's instructions.

### 510.10.3 Size of Vent Connector.

**510.10.3.1** A vent connector for gas utilization equipment with a single draft hood or for a Category I fan-assisted combustion system appliance shall be sized

and installed in accordance with this chapter or other approved engineering methods.

**TABLE 5-7**

### Minimum Thickness for Steel Vent Connectors for Medium-Heat Equipment and Commercial and Industrial Incinerators

Vent Connector Size		Minimum
Diameter (in.)	Area (in. <sup>2</sup> )	Thickness (in.)
Up to 14	Up to 154	0.053
Over 14 to 16	154 to 201	0.067
Over 16 to 18	201 to 254	0.093
Over 18	Larger than 254	0.123

For SI units, 1 in. = 25.4 mm; 1 in.<sup>2</sup> = 645 mm<sup>2</sup>.

[NFPA 54: Table 9.10.2 (f)]

**510.10.3.2** For a single appliance having more than one draft hood outlet or flue collar, the manifold shall be constructed according to the instructions of the appliance manufacturer. Where there are no instructions, the manifold shall be designed and constructed in accordance with approved engineering practices. As an alternate method, the effective area of the manifold shall equal the combined area of the flue collars or draft hood outlets, and the vent connectors shall have a minimum 1 ft (0.3 m) rise.

**510.10.3.3** Where two or more gas appliances are connected to a common vent or chimney, each vent connector shall be sized in accordance with this chapter or other approved engineering methods. As an alternative method applicable only when all of the appliances are draft-hood-equipped, each vent connector shall have an effective area not less than the area of the draft hood outlet of the appliance to which it is connected.

**510.10.3.4** Where two or more gas appliances are vented through a common vent connector or vent manifold, the common vent connector or vent manifold shall be located at the highest level consistent with available headroom and clearance to combustible material and shall be sized in accordance with this chapter or other approved engineering methods.

As an alternate method applicable only where there are two draft-hood-equipped appliances, the effective area of the common vent connector or vent manifold and all junction fittings shall be not less than the area of the larger vent connector plus 50 percent of the areas of smaller flue collar outlets.

**510.10.3.5** Where the size of a vent connector is increased to overcome installation limitations and obtain connector capacity equal to the equipment input, the size increase shall be made at the equipment draft hood outlet.

**510.10.4 Two or More Appliances Connected to a Single Vent.**

**510.10.4.1** Where two or more vent connectors enter a common gas vent, chimney flue, or single-wall metal pipe, the smaller connector shall enter at the highest level consistent with the available headroom or clearance to combustible material.

**510.10.4.2** Vent connectors serving Category I appliances shall not be connected to any portion of a mechanical draft system operating under positive static pressure, such as those serving Category III or Category IV appliances.

**510.10.5 Clearance.** Minimum clearances from vent connectors to combustible material shall be in accordance with Table 5-4.

**Exception:** The clearance between a vent connector and combustible material shall be permitted to be reduced where the combustible material is protected as specified for vent connectors in Table 5-5.

**510.10.6 Avoid Unnecessary Bends.** A vent connector shall be installed so as to avoid turns or other construction features that create excessive resistance to flow of vent gases.

**510.10.7 Joints.** Joints between sections of connector piping and connections to flue collars or draft hood outlets shall be fastened in accordance with one of the following methods

- (1) By sheet metal screws.
- (2) Vent connectors of listed vent material shall be assembled and connected to flue collars or draft hood outlets in accordance with the manufacturers' instructions.
- (3) Other approved means.

**510.10.8 Slope.** A vent connector shall be installed without any dips or sags and shall

slope upward toward the vent or chimney at least 1/4 in./ft (20 mm/m).

**Exception:** Vent connectors attached to a mechanical draft system installed in accordance with the manufacturers' instructions.

**510.10.9 Length of Vent Connector.**

**510.10.9.1** A vent connector shall be as short as practical and the gas utilization equipment located as close as practical to the chimney or vent.

**510.10.9.2** Except as provided for in 510.10.3, the maximum horizontal length of a single-wall connector shall be 75 percent of the height of the chimney or vent. Except as provided for in 510.10.3, the maximum horizontal length of a Type B double-wall connector shall be 100 percent of the height of the chimney or vent. For a chimney or vent system serving multiple appliances, the maximum length of an individual connector, from the appliance outlet to the junction with the common vent or another connector, shall be 100 percent of the height of the chimney or vent.

**510.10.10 Support.** A vent connector shall be supported for the design and weight of the material employed to maintain clearances and prevent physical damage and separation of joints.

**510.10.11 Chimney Connection.** Where entering a flue in a masonry or metal chimney, the vent connector shall be installed above the extreme bottom to avoid stoppage. Where a thimble or slip joint is used to facilitate removal of the connector, the connector shall be firmly attached to or inserted into the thimble or slip joint to prevent the connector from falling out. Means shall be employed to prevent the connector from entering so far as to restrict the space between its end and the opposite wall of the chimney flue.

**510.10.12 Inspection.** The entire length of a vent connector shall be readily accessible for inspection, cleaning, and replacement.

**510.10.13 Fireplaces.** A vent connector shall not be connected to a chimney flue serving a fireplace unless the fireplace flue opening is permanently sealed.

**510.10.14 Passage through Ceilings, Floors, or Walls.**

**510.10.14.1** A vent connector shall not pass through any ceiling, floor, or fire-resistance rated wall. A single-wall metal pipe



connector shall not pass through any interior wall.

**Exception:** Vent connectors made of listed Type B or Type L vent material and serving listed equipment with draft hoods and other equipment listed for use with Type B gas vents that pass through walls or partitions constructed of combustible material shall be installed with not less than the listed clearance to combustible material.

**510.10.14.2** A vent connector made of a single-wall metal pipe shall not pass through a combustible exterior wall unless guarded at the point of passage by a ventilated metal thimble not smaller than the following:

- (1) For listed appliances equipped with draft hoods and appliances listed for use with Type B gas vents, the thimble shall be a minimum of 4 in. (100 mm) larger in diameter than the vent connector. Where there is a run of not less than 6 ft (1.8 m) of vent connector in the opening between the draft hood outlet and the thimble, the thimble shall be a minimum of 2 in. (50 mm) larger in diameter than the vent connector.
- (2) For unlisted appliances having draft hoods, the thimble shall be a minimum of 6 in. (150 mm) larger in diameter than the vent connector.
- (3) For residential and low-heat appliances, the thimble shall be a minimum of 12 in. (300 mm) larger in diameter than the vent connector.

**Exception:** In lieu of thimble protection, all combustible material in the wall shall be removed from the vent connector a sufficient distance to provide the specified clearance from such vent connector to combustible material. Any material used to close up such opening shall be noncombustible.

**510.10.14.3** Vent connectors for medium-heat equipment shall not pass through walls or partitions constructed of combustible material. [NFPA 54:10.10.14.3]

**510.11 Vent Connectors for Category II, Category III, and Category IV Gas Utilization Equipment.** (See Section 510.4.) [NFPA 54:10.11]

## **510.12 Draft Hoods and Draft Controls.**

**510.12.1 Equipment Requiring Draft Hoods.** Vented gas utilization equipment shall be installed with draft hoods.

**Exception:** Dual oven-type combination ranges, incinerators, direct-vent equipment, fan-assisted combustion system appliances, equipment requiring chimney draft for operation, single firebox boilers equipped with conversion burners with inputs greater than 400,000 Btu/h (117 kW), equipment equipped with blast, power, or pressure burners that are not listed for use with draft hoods, and equipment designed for forced venting.

**510.12.2 Installation.** A draft hood supplied with or forming a part of listed vented gas utilization equipment shall be installed without alteration, exactly as furnished and specified by the equipment manufacturer. If a draft hood is not supplied by the equipment manufacturer where one is required, a draft hood shall be installed, be of a listed or approved types, and, in the absence of other instructions, be of the same size as the equipment flue collar. Where a draft hood is required with a conversion burner, it shall be of a listed or approved type. Where it is determined that a draft hood of special design is needed or preferable for a particular installation, the installation shall be in accordance with the recommendations of the equipment manufacturer and shall be with the approval of the Authority Having Jurisdiction.

**510.12.3 Draft-Control Devices.** Where a draft control device is part of the gas utilization equipment or is supplied by the equipment manufacturer, it shall be installed in accordance with the manufacturer's instructions. In the absence of manufacturer's instructions, the device shall be attached to the flue collar of the equipment or as near to the equipment as practical.

**510.12.4 Additional Devices.** Gas utilization equipment (except incinerators) requiring controlled chimney draft shall be permitted to be equipped with a listed double-acting barometric draft regulator installed and adjusted in accordance with the manufacturers' instructions.

**510.12.5 Location.** Draft hoods and barometric draft regulators shall be installed

in the same room or enclosure as the equipment in such a manner as to prevent any difference in pressure between the hood or regulator and the combustion air supply.

**510.12.6 Positioning.** Draft hoods and draft regulators shall be installed in the position for which they were designed with reference to the horizontal and vertical planes and shall be located so that the relief opening is not obstructed by any part of the equipment or adjacent construction. The equipment and its draft hood shall be located so that the relief opening is accessible for checking vent operation.

**510.12.7 Clearance.** A draft hood shall be located so that its relief opening is not less than 6 in. (150 mm) from any surface except that of the equipment it serves and the venting system to which the draft hood is connected. Where a greater or lesser clearance is indicated on the equipment label, the clearance shall not be less than that specified on the label. Such clearances shall not be reduced. [NFPA 54:10.12.7]

**510.13 Manually Operated Dampers.** A manually operated damper shall not be placed in any equipment vent connector. Fixed baffles shall not be classified as manually operated dampers. [NFPA 54:10.13]

**510.14 Automatically Operated Vent Dampers.** An automatically operated vent damper shall be of a listed type. [NFPA 54:10.14]

**510.15 Obstructions.** Devices that retard the flow of vent gases shall not be installed in a vent connector, chimney, or vent. The following shall not be considered as obstructions:

- (1) Draft regulators and safety controls specifically listed for installation in venting systems and installed in accordance with the terms of their listing.
- (2) Approved draft regulators and safety controls designed and installed in accordance with approved engineering methods.
- (3) Listed heat reclaimers and automatically operated vent dampers installed in accordance with the terms of their listing.
- (4) Vent dampers serving listed appliances installed in accordance with this chapter or other approved engineering methods.
- (5) Approved economizers, heat reclaimers, and recuperators installed in venting systems of equipment not required to be equipped with draft hoods, provided the gas utilization equipment manufacturer's instructions cover the installation of such a device in the venting system and performance in accordance with 510.3.1 and 510.3.2 is obtained. [NFPA 54:10.15(b)]

### 511.0 Sizing of Category I Venting Systems.

**511.1 Obstructions and Vent Dampers.** These venting tables shall not be used where obstructions (see Section 510.15) are installed in the venting system. The installation of vents serving listed appliances with vent dampers shall be in accordance with the appliance manufacturer's instructions or in accordance with the following:

- (1) The maximum capacity of the vent system shall be determined using the NAT MAX column.
- (2) The maximum capacity shall be determined as if the appliance were a fan-assisted appliance, using the FAN MIN column to determine the minimum capacity of the vent system. Where the corresponding FAN MIN is NA, the vent configuration shall not be permitted and an alternative venting configuration shall be utilized.

**511.1.1** Where the vent size determined from the tables is smaller than the appliance draft hood outlet or flue collar, the use of the smaller size shall be permitted provided that the installation complies with all of the following requirements:

- (1) The total vent height (H) is at least 10 ft (3 m).
- (2) Vents for appliance draft hood outlets or flue collars 12 in. (300 mm) in diameter or smaller are not reduced more than one table size.
- (3) Vents for appliance draft hood outlets or flue collars larger than 12 in. (300 mm) in diameter are not reduced more than two table sizes.
- (4) The maximum capacity listed in the tables for a fan-assisted appliance is reduced by 10 percent (0.90 maximum table capacity).
- (5) The draft hood outlet is greater than 4 in. (100 mm) in diameter. Do not connect a 3 in. (80mm) diameter vent to a 4 in. (100mm) diameter draft hood outlet. This provision shall not apply to fan-assisted appliances.

**511.1.2** Single-appliance venting configurations with zero (0) lateral lengths in Tables 5-9, 5-10, and 5-13 shall have no elbows in the venting system. For vent configurations with lateral

lengths, the venting tables include allowance for two 90 degree turns. For each additional elbow up to and including 45 degrees, the maximum capacity listed in the venting tables shall be reduced by 5 percent. For each elbow greater than 45 degrees up to and including 90 degrees, the maximum capacity listed in the venting tables shall be reduced by 10 percent.

**511.1.3** Zero (0) lateral (L) shall apply only to a straight vertical vent attached to a top outlet draft hood or flue collar.

**511.1.4** Sea level input ratings shall be used when determining maximum capacity for high-altitude installation. Actual input (derated for altitude) shall be used for determining minimum capacity for high-altitude installation.

**511.1.5** For appliances with more than one input rate, the minimum vent capacity (FAN Min) determined from the tables shall be less than the lowest appliance input rating, and the maximum vent capacity (FAN Max/NAT Max) determined from the tables shall be greater than the highest appliance rating input.

**511.1.6** Listed corrugated metallic chimney liner systems in masonry chimneys shall be sized by using Table 5-9 or 5-10 for Type B vents with the maximum capacity reduced by 20 percent (0.80 maximum capacity) and the minimum capacity as shown in Table 5-9 or 5-10. Corrugated metallic liner systems installed with bends or offsets shall have their maximum capacity further reduced in accordance with 511.1.2. The 20 percent reduction for corrugated metallic chimney liner systems includes an allowance for one long radius 90 degree turn at the bottom of the liner.

**511.1.7** Where the vertical vent has a larger diameter than the vent connector, the vertical vent diameter shall be used to determine the minimum vent capacity, and the connector diameter shall be used to determine the maximum vent capacity. The flow area of the vertical vent shall not exceed seven times the flow area of the listed appliance categorized vent area, flue collar area, or draft hood outlet area unless designed in accordance with approved engineering methods.

**511.1.8** Tables 5-9 through 5-13 shall be used for chimneys and vents not exposed to the outdoors below the roof line. A Type B vent or listed chimney lining system passing through an unused masonry chimney flue shall not be considered to be exposed to the outdoors. Table 5-11 in combination with Table 5-19 shall be

used for clay-tile-lined exterior masonry chimneys, provided all of the following are met:

- (1) The vent connector is Type B double wall.
- (2) The vent connector length is limited to 1-1/2 ft for each inch (180 mm/mm) of vent connector diameter.
- (3) The appliance is draft hood equipped.
- (4) The input rating is less than the maximum capacity given in Table 5-11.
- (5) For a water heater, the outdoor design temperature shall not be less than 5°F (15°C).
- (6) For a space-heating appliance, the input rating is greater than the minimum capacity given by Table 5-19.

**Exception:** Vents serving listed appliances installed in accordance with the appliance instructions and the terms of the listing.

**511.1.9** Corrugated vent connectors shall not be smaller than the listed appliance categorized vent diameter, flue collar diameter, or draft hood outlet diameter.

**511.1.10** Vent connectors shall not be upsized more than two sizes greater than the listed appliance categorized vent diameter, flue collar diameter, or draft hood outlet diameter.

**511.1.11** In a single run of vent or vent connector, more than one diameter and type shall be permitted to be used, provided that all the sizes and types are permitted by the tables.

**511.1.12** Interpolation shall be permitted in calculating capacities for vent dimensions that fall between table entries. (See Part II-Example G.1.3.)

**511.1.13** Extrapolation beyond the table entries shall not be permitted.

**511.1.14** For vent heights lower than 6 ft and higher than shown in the tables, engineering methods shall be used to calculate vent capacities.

## **511.2 Additional Requirements to Multiple Appliance Vent Table 5-14 through Table 5-21(a) and Table 5-21(b).**

**511.2.1 Obstructions and Vent Damper.** These venting tables shall not be used where obstructions (see Section 510.15) are installed in the venting system. The installation of vents serving listed appliances with vent dampers shall be in accordance with the appliance manufacturer's instructions or in accordance with the following:

- (1) The maximum capacity of the vent connector shall be determined using the NAT Max column.
- (2) The maximum capacity of the vertical vent

or chimney shall be determined using the FAN + NAT column when the second appliance is a fan-assisted appliance, or the NAT + NAT column when the second appliance is equipped with a draft hood.

- (3) The minimum capacity shall be determined as if the appliance were a fan-assisted appliance.
  - (a) The minimum capacity of the vent connector shall be determined using the FAN Min column.
  - (b) The FAN + FAN column shall be used when the second appliance is a fan-assisted appliance, and the FAN + NAT column shall be used when the second appliance is equipped with a draft hood, to determine whether the vertical vent or chimney configuration is not permitted (NA). Where the vent configuration is NA, the vent configuration shall not be permitted and an alternative venting configuration shall be utilized.

**511.2.2** The maximum vent connector horizontal length shall be 18 in./in. (180 mm/mm) of connector diameter as shown in Table 5-8:

**TABLE 5-8**  
**Vent Connector Maximum Length**

Connector Diameter Maximum (in.)	Connector Horizontal Length (ft.)
3	4-1/2
4	6
5	7-1/2
6	9
7	10-1/2
8	12
9	13-1/2
10	15
12	18
14	21
16	24
18	27
20	30
22	33
24	36

For SI units, 1 in. = 25.4 mm; 1 ft = 0.305 m.  
[NFPA 54 Table 13.2.2]

**511.2.3** The vent connector shall be routed to the vent utilizing the shortest possible route. Connectors with longer horizontal lengths than those listed in Table 5-8 are permitted under the following conditions:

- (A) The maximum capacity (FAN Max or NAT Max) of the vent connector shall be reduced 10 percent for each additional multiple of the length listed in Table 5-8. For example, the maximum length listed for a 4 in. (100 mm) connector is 6 ft (1.8 m). With a connector length greater than 6 ft (1.8 m) but not exceeding 12 ft (3.7 m), the maximum capacity must be reduced by 10 percent (0.90 maximum vent connector capacity). With a connector length greater than 12 ft (3.7 m) but not exceeding 18 ft (5.5 m), the maximum capacity must be reduced by 20 percent (0.80 maximum vent capacity).
- (B) For a connector serving a fan-assisted appliance, the minimum capacity (FAN Min) of the connector shall be determined by referring to the corresponding single appliance table. For Type B double-wall connectors, Table 5-9 shall be used. For single-wall connectors, Table 5-10 shall be used. The height (H) and lateral (L) shall be measured according to the procedures for a single appliance vent, as if the other appliances were not present.

**511.2.4** Where the vent connectors are combined prior to entering the vertical portion of the common vent to form a common vent manifold, the size of the common vent manifold and the common vent shall be determined by applying a 10 percent reduction (.90 x maximum common vent capacity) to the Common Vent Capacity part of the common vent tables. The length of the common vent connector manifold (LM) shall not exceed 18 in./in. (180 mm/mm) of common vent connector manifold diameter (D). (See Part II-Figure G.1(k).)

**511.2.5** Where the common vertical vent is offset, the maximum capacity of the common vent shall be reduced in accordance with 511.2.6 and the horizontal length of the common vent offset shall not exceed 18 in./in. (180 mm/mm) of common vent diameter.

**511.2.6** For each elbow up to and including 45 degrees in the common vent, the maximum common vent capacity listed in the venting tables shall be reduced by 5 percent. For each elbow greater than 45 degrees up to and including 90 degrees, the maximum common

vent capacity listed in the venting tables shall be reduced by 10 percent.

**511.2.7** The vent connector capacities listed in the common vent sizing tables include allowance for two 90 degree elbows. For each additional elbow up to and including 45 degrees, the maximum vent connector capacity listed in the venting tables shall be reduced by 5 percent. For each elbow greater than 45 degrees up to and including 90 degrees, the maximum vent connector capacity listed in the venting tables shall be reduced by 10 percent.

**511.2.8** At the point where tee or wye fittings connect to a common vent, the opening size of the fitting shall be equal to the size of the common vent. Such fittings shall not be prohibited from having reduced size openings at the point of connection of appliance vent connectors.

**511.2.9** Sea level input ratings shall be used when determining maximum capacity for high-altitude installation. Actual input (derated for altitude) shall be used for determining minimum capacity for high-altitude installation.

**511.2.10** The connector rise (R) for each appliance connector shall be measured from the draft hood outlet or flue collar to the centerline where the vent gas streams come together.

**511.2.11** For multiple units of gas utilization equipment all located on one floor, available total height (H) shall be measured from the highest draft hood outlet or flue collar up to the level of the outlet of the common vent.

**511.2.12** For multistory installations, available total height (H) for each segment of the system shall be the vertical distance between the highest draft hood outlet or flue collar entering that segment and the centerline of the next higher interconnection tee. (See Part II-Figure G.1(j).)

**511.2.13** The size of the lowest connector and of the vertical vent leading to the lowest interconnection of a multistory system shall be in accordance with Table 5-9 or 5-10 for available total height (H) up to the lowest interconnection. (See Part II-Figure G.1(n).)

**511.2.14** Where used in multistory systems, vertical common vents shall be Type B double-wall and shall be installed with a listed vent cap.

**511.2.15** Offsets in multistory common vent systems shall be limited to a single offset in each system, and systems with an offset shall comply with all of the following:

- (1) The offset angle shall not exceed 45 degrees from vertical.
- (2) The horizontal length of the offset shall not exceed 18 inches for each inch (180 mm/mm) of common vent diameter of the segment in which the offset is located.
- (3) For the segment of the common vertical vent containing the offset, the common vent capacity listed in the common venting tables shall be reduced by 20 percent (0.80 x maximum common vent capacity).
- (4) A multistory common vent shall not be reduced in size above the offset.

**511.2.16** Where two or more appliances are connected to a vertical vent or chimney, the flow area of the largest section of vertical vent or chimney shall not exceed seven times the smallest listed appliance categorized vent areas, flue collar area, or draft hood outlet area unless designed in accordance with approved engineering methods.

**511.2.17** For appliances with more than one input rate, the minimum vent connector capacity (FAN Min) determined from the tables shall be less than the lowest appliance input rating, and the maximum vent connector capacity (FAN Max or NAT Max) determined from the table shall be greater than the highest appliance input rating.

**511.2.18** Listed corrugated metallic chimney liner systems in masonry chimneys shall be sized by using Table 5-14 or 5-15 for Type B vents, with the maximum capacity reduced by 20 percent (0.80 maximum capacity) and the minimum capacity as shown in Table 5-14 or 5-15. Corrugated metallic liner systems installed with bends or offsets shall have their maximum capacity further reduced in accordance with 511.2.5 and 511.2.6. The 20% reduction for corrugated metallic chimney liner systems includes an allowance for one long radius 90 degree turn at the bottom of the liner.

**511.2.19** Tables 5-14 through 5-18 shall be used for chimneys and vents not exposed to the outdoors below the roof line. A Type B vent or listed chimney lining system passing through an unused masonry chimney flue shall not be considered to be exposed to the outdoors. Tables 5-20 and 5-21 shall be used for clay-tile-lined exterior masonry chimneys, provided all of the following conditions are met:

- (1) Vent connector is Type B double-wall.
- (2) At least one appliance is draft-hood-equipped.

- (3) The combined appliance input rating is less than the maximum capacity given by Table 5-20(a) (for NAT + NAT) or Table 5-21(a) (for FAN + NAT).
- (4) The input rating of each space-heating appliance is greater than the minimum input rating given by Table 5-20(b) (for NAT + NAT) or Table 5-21(a) (for FAN + NAT).
- (5) The vent connector sizing is in accordance with Table 5-16. Where these conditions cannot be met, an alternative venting design shall be used, such as a listed chimney lining system.

**Exception:** Vents serving listed appliances installed in accordance with the appliance manufacturer's instructions and the terms of the listing.

**511.2.20** Vent connectors shall not be increased more than two sizes greater than the listed appliance categorized vent diameter, flue collar diameter, or draft hood outlet diameter. Vent connectors for draft-hood-equipped appliances shall not be smaller than the draft hood outlet diameter. Where vent connector sizes determined from the tables for fan-assisted appliances are smaller than the flue collar diameter, the use of the smaller sizes shall be permitted provided that the installation complies with all of the following conditions:

- (1) Vent connectors for fan-assisted appliance flue collars 12 in. (300 mm) in diameter or smaller are not reduced by more than one table size [e.g., 12 in. to 10 in. (300 mm to 250 mm) is a one-size reduction] and those larger than 12 in. (300 mm) in diameter are not reduced more than two table sizes [e.g., 24 in. to 20 in. (610 mm to 510 mm) is a two-size reduction].
- (2) Fan-assisted appliances are common vented with a draft-hood-equipped appliance.
- (3) The vent connector has a smooth interior wall.

**511.2.21** All combinations of pipe sizes, single-wall, and double-wall metal pipe shall be allowed within any connector runs or within the common vent, provided ALL of the appropriate tables permit ALL of the desired sizes and types of pipe, as if they were used for the entire length of the subject connector or vent. Where single-wall and Type B double-wall metal pipes are used for vent connectors within the same venting system, the common vent must be sized

using Table 5-15 or 5-17 as appropriate.

**511.2.22** Where a table permits more than one diameter of pipe to be used for a connector or vent, all the permitted sizes shall be permitted to be used.

**511.2.23** Interpolation shall be permitted in calculating capacities for vent dimensions that fall between table entries. (See Part II Annex G.1.3.)

**511.2.24** Extrapolation beyond the table entries shall not be permitted.

**511.2.25** For vent heights lower than 6 ft and higher than shown in the tables, engineering methods shall be used to calculate vent capacities.

**512.0 Direct-Vent Equipment.** Listed direct-vent gas utilization equipment shall be considered properly vented where installed in accordance with the terms of its listing, the manufacturers' instructions, and Section 510.8.3.

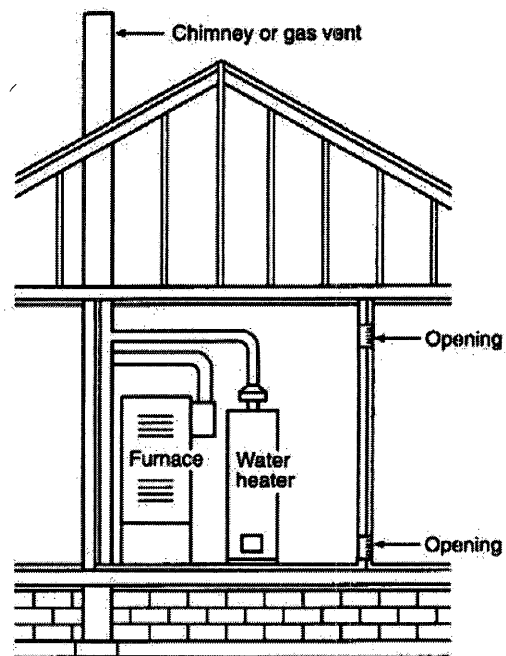

**FIGURE 5-8 All Combustion Air from Indoor Spaces through Indoor Combustion Air Openings.**

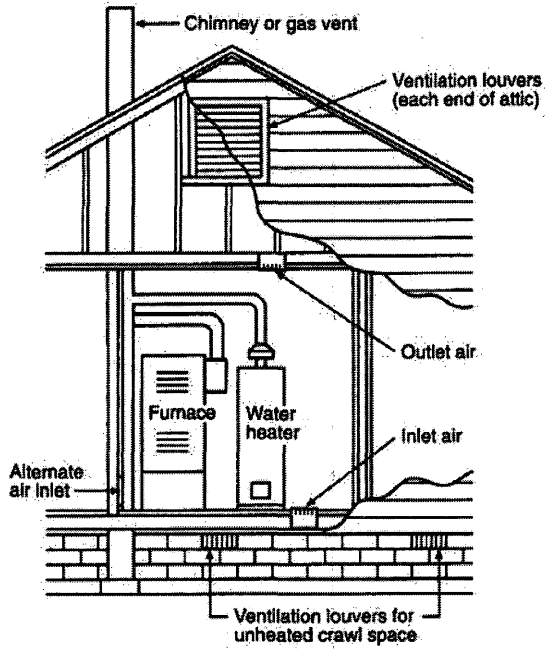

FIGURE 5-9 All Combustion Air from Outdoors - Inlet Air from Ventilated Crawl Space and Outlet Air to Ventilated Attic.

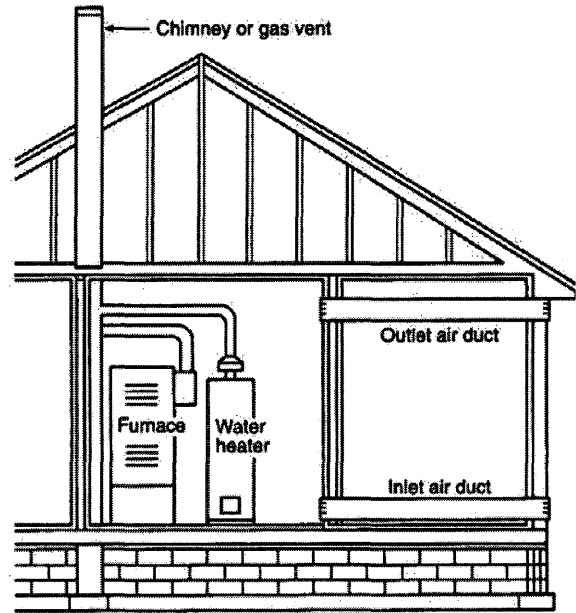

FIGURE 5-11 All Combustion Air from Outdoors through Horizontal Ducts.

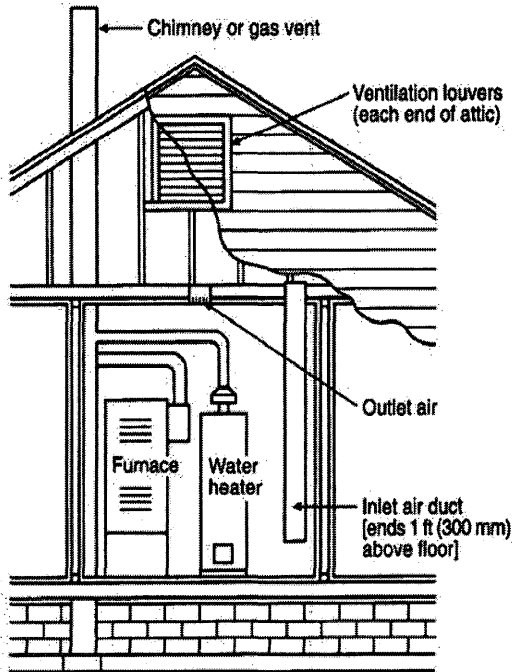

FIGURE 5-10 All Combustion Air from Outdoors through Ventilated Attic.

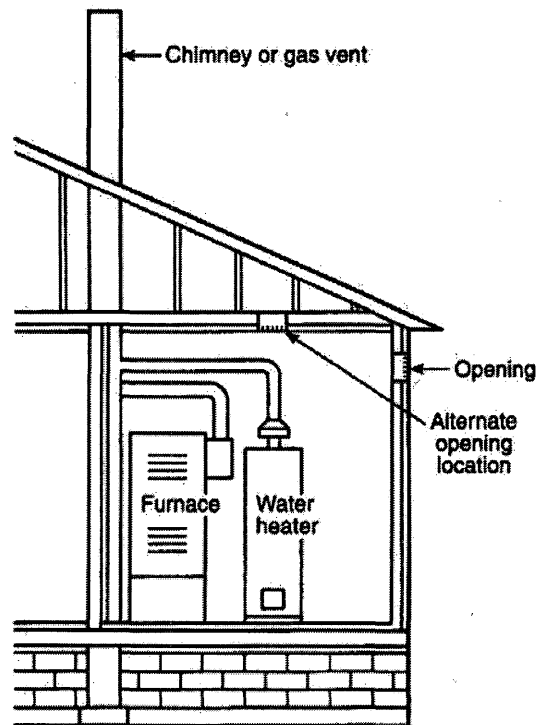

FIGURE 5-12 All Combustion Air from Outdoors through Single Combustion Air Opening.

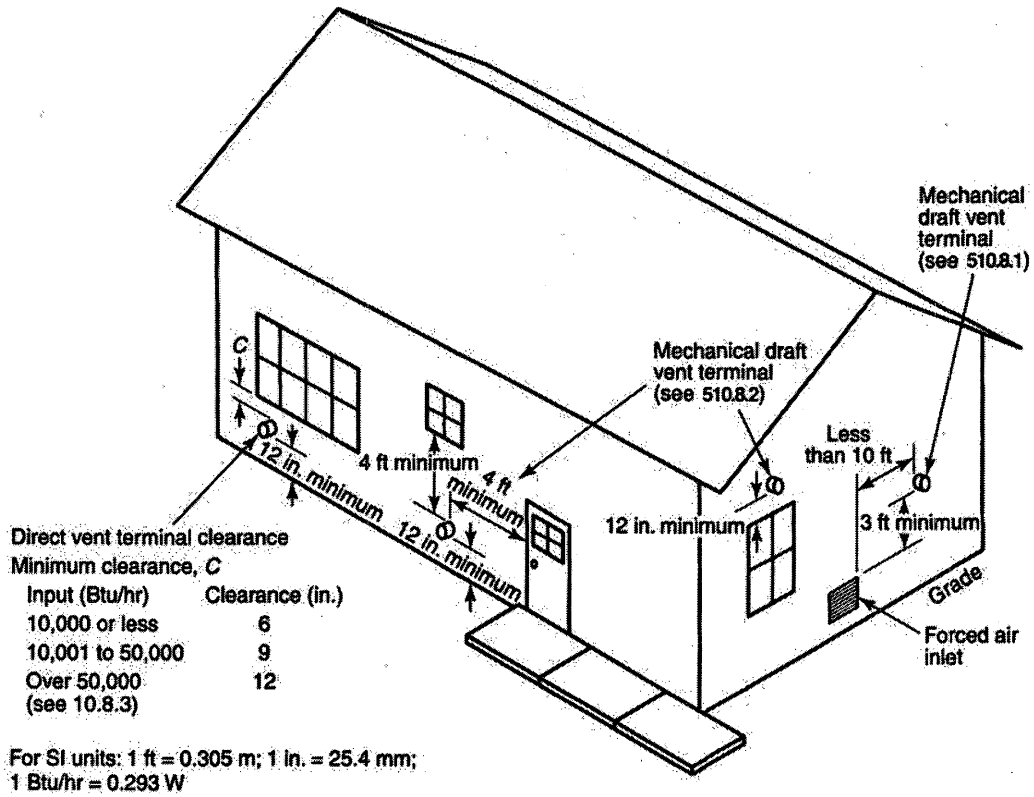

FIGURE 5-13 Exit Terminals of Mechanical Draft and Direct-Vent Venting Systems.



99% Winter Design Temperatures for the Contiguous United States

This map is a necessarily generalized guide to temperatures in the contiguous United States. Temperatures shown for areas such as mountainous regions and large urban centers may not be accurate. The data used to develop this map are from the 1993 ASHRAE Handbook—Fundamentals (Chapter 24, Table 1: Climate Conditions for the United States).

For 99% winter design temperatures in Alaska, consult the ASHRAE Handbook—Fundamentals.

99% winter design temperatures for Hawaii are greater than 37°F.

FIGURE 5-14 Range of Winter Design Temperatures Used in Analyzing Exterior Masonry Chimneys in the United States.



Table 5-9 Type B Double-Wall Gas Vent

		Number of Appliances:															Single					
		Appliance Type:															Category I					
		Appliance Vent Connection:															Connected Directly to Vent					
Vent Diameter — D (in.)																						
		3			4			5			6			7			8			9		
Height H (ft.)	Lateral L (ft.)	Appliance Input Rating in Thousands of Btu per Hour																				
		FAN		NAT	FAN		NAT	FAN		NAT	FAN		NAT	FAN		NAT	FAN		NAT	FAN		NAT
		Min	Max	Max	Min	Max	Max	Min	Max	Max	Min	Max	Max	Min	Max	Max	Min	Max	Max	Min	Max	Max
6	0	0	78	46	0	152	86	0	251	141	0	375	205	0	524	285	0	698	370	0	897	470
	2	13	51	36	18	97	67	27	157	105	32	232	157	44	321	217	53	425	285	63	543	370
	4	21	49	34	30	94	64	39	153	103	50	227	153	66	316	211	79	419	279	93	536	362
	6	25	46	32	36	91	61	47	149	100	59	223	149	78	310	205	93	413	273	110	530	354
8	0	0	84	50	0	165	94	0	276	155	0	415	235	0	583	320	0	780	415	0	1006	537
	2	12	57	40	16	109	75	25	178	120	28	263	180	42	365	247	50	483	322	60	619	418
	5	23	53	38	32	103	71	42	171	115	53	255	173	70	356	237	83	473	313	99	607	407
	8	28	49	35	39	98	66	51	164	109	64	247	165	84	347	227	99	463	303	117	596	396
10	0	0	88	53	0	175	100	0	295	166	0	447	255	0	631	345	0	847	450	0	1096	585
	2	12	61	42	17	118	81	23	194	129	26	289	195	40	402	273	48	533	355	57	684	457
	5	23	57	40	32	113	77	41	187	124	52	280	188	68	392	263	81	522	346	95	671	446
	10	30	51	36	41	104	70	54	176	115	67	267	175	88	376	245	104	504	330	122	651	427
15	0	0	94	58	0	191	112	0	327	187	0	502	285	0	716	390	0	970	525	0	1263	682
	2	11	69	48	15	136	93	20	226	150	22	339	225	38	475	316	45	633	414	53	815	544
	5	22	65	45	30	130	87	39	219	142	49	330	217	64	463	300	76	620	403	90	800	529
	10	29	59	41	40	121	82	51	206	135	64	315	208	84	445	288	99	600	386	116	777	507
	15	35	53	37	48	112	76	61	195	128	76	301	198	98	429	275	115	580	373	134	755	491
20	0	0	97	61	0	202	119	0	349	202	0	540	307	0	776	430	0	1057	575	0	1384	752
	2	10	75	51	14	149	100	18	250	166	20	377	249	33	531	346	41	711	470	50	917	612
	5	21	71	48	29	143	96	38	242	160	47	367	241	62	519	337	73	697	460	86	902	599
	10	28	64	44	38	133	89	50	229	150	62	351	228	81	499	321	95	675	443	112	877	576
	15	34	58	40	46	124	84	59	217	142	73	337	217	94	481	308	111	654	427	129	853	557
	20	48	52	35	55	116	78	69	206	134	84	322	206	107	464	295	125	634	410	145	830	537
30	0	0	100	64	0	213	128	0	374	220	0	587	336	0	853	475	0	1173	650	0	1548	855
	2	9	81	56	13	166	112	14	283	185	18	432	280	27	613	394	33	826	535	42	1072	700
	5	21	77	54	28	160	108	36	275	176	45	421	273	58	600	385	69	811	524	82	1055	688
	10	27	70	50	37	150	102	48	262	171	59	405	261	77	580	371	91	788	507	107	1028	668
	15	33	64	NA	44	141	96	57	249	163	70	389	249	90	560	357	105	765	490	124	1002	648
	20	56	58	NA	53	132	90	66	237	154	80	374	237	102	542	343	119	743	473	139	977	628
	30	NA	NA	NA	73	113	NA	88	214	NA	104	346	219	131	507	321	149	702	444	171	929	594
50	0	0	101	67	0	216	134	0	397	232	0	633	363	0	932	518	0	1297	708	0	1730	952
	2	8	86	61	11	183	122	14	320	206	15	497	314	22	715	445	26	975	615	33	1276	813
	5	20	82	NA	27	177	119	35	312	200	43	487	308	55	702	438	65	960	605	77	1259	798
	10	26	76	NA	35	168	114	45	299	190	56	471	298	73	681	426	86	935	589	101	1230	773
	15	59	70	NA	42	158	NA	54	287	180	66	455	288	85	662	413	100	911	572	117	1203	747
	20	NA	NA	NA	50	149	NA	63	275	169	76	440	278	97	642	401	113	888	556	131	1176	722
	30	NA	NA	NA	69	131	NA	84	250	NA	99	410	259	123	605	376	141	844	522	161	1125	670
100	0	NA	NA	NA	0	218	NA	0	407	NA	0	665	400	0	997	560	0	1411	770	0	1908	1040
	2	NA	NA	NA	10	194	NA	12	354	NA	13	566	375	18	831	510	21	1155	700	25	1536	935
	5	NA	NA	NA	26	189	NA	33	347	NA	40	557	369	52	820	504	60	1141	692	71	1519	926
	10	NA	NA	NA	33	182	NA	43	335	NA	53	542	361	68	801	493	80	1118	679	94	1492	910
	15	NA	NA	NA	40	174	NA	50	321	NA	62	528	353	80	782	482	93	1095	666	109	1465	895
	20	NA	NA	NA	47	166	NA	59	311	NA	71	513	344	90	763	471	105	1073	653	122	1438	880
	30	NA	NA	NA	NA	NA	NA	78	290	NA	92	483	NA	115	726	449	131	1029	627	149	1387	849
	50	NA	NA	NA	NA	NA	NA	NA	NA	NA	147	428	NA	180	651	405	197	944	575	217	1288	787

Table 5-9 Continued

		Number of Appliances:												Single											
		Appliance Type:												Category I											
		Appliance Vent Connection:												Connected Directly to Vent											
		Vent Diameter — D (in.)																							
		Appliance Input Rating in Thousands of Btu per Hour																							
Height Lateral H L (ft) (ft)		10			12			14			16			18			20			22			24		
		FAN	NAT	Max	FAN	NAT	Max	FAN	NAT	Max	FAN	NAT	Max	FAN	NAT	Max	FAN	NAT	Max	FAN	NAT	Max	FAN	NAT	Max
		Min	Max	Max	Min	Max	Max	Min	Max	Max	Min	Max	Max	Min	Max	Max	Min	Max	Max	Min	Max	Max	Min	Max	Max
6	0	0	1121	570	0	1645	850	0	2267	1170	0	2983	1530	0	3802	1960	0	4721	2430	0	5737	2950	0	6853	3520
	2	75	675	455	103	982	650	138	1346	890	178	1769	1170	225	2250	1480	296	2782	1850	360	3377	2220	426	4030	2670
	4	110	668	445	147	975	640	191	1338	880	242	1761	1160	300	2242	1475	390	2774	1835	469	3370	2215	555	4023	2660
	6	128	661	435	171	967	630	219	1330	870	276	1753	1150	341	2235	1470	437	2767	1820	523	3363	2210	618	4017	2650
8	0	0	1261	660	0	1858	970	0	2571	1320	0	3399	1740	0	4333	2220	0	5387	2750	0	6555	3360	0	7838	4010
	2	71	770	515	98	1124	745	130	1543	1020	168	2030	1340	212	2584	1700	278	3196	2110	336	3882	2560	401	4634	3050
	5	115	758	503	154	1110	733	199	1528	1010	251	2013	1330	311	2563	1685	398	3180	2090	476	3863	2545	562	4612	3040
	8	137	746	490	180	1097	720	231	1514	1000	289	2000	1320	354	2552	1670	450	3163	2070	537	3850	2530	630	4602	3030
10	0	0	1377	720	0	2036	1060	0	2825	1450	0	3742	1925	0	4782	2450	0	5955	3050	0	7254	3710	0	8682	4450
	2	68	852	560	93	1244	850	124	1713	1130	162	2256	1480	202	2868	1890	264	3556	2340	319	4322	2840	378	5153	3390
	5	112	839	547	149	1229	829	192	1696	1105	243	2238	1461	300	2849	1871	382	3536	2318	458	4301	2818	540	5132	3371
	10	142	817	525	187	1204	795	238	1669	1080	298	2209	1430	364	2818	1840	459	3504	2280	546	4268	2780	641	5099	3340
15	0	0	1596	840	0	2380	1240	0	3323	1720	0	4423	2270	0	5678	2900	0	7099	3620	0	8665	4410	0	10393	5300
	2	63	1019	675	86	1495	985	114	2062	1350	147	2719	1770	186	3467	2260	239	4304	2800	290	5232	3410	346	6251	4080
	5	105	1003	660	140	1476	967	182	2041	1327	229	2696	1748	283	3442	2235	355	4278	2777	426	5204	3385	501	6222	4057
	10	135	977	635	177	1446	936	227	2009	1289	283	2659	1712	346	3402	2193	432	4234	2739	510	5159	3343	599	6175	4019
	15	155	953	610	202	1418	905	257	1976	1250	318	2623	1675	385	3363	2150	479	4192	2700	564	5115	3300	665	6129	3980
20	0	0	1756	930	0	2637	1350	0	3701	1900	0	4948	2520	0	6376	3250	0	7988	4060	0	9785	4980	0	11753	6000
	2	59	1150	755	81	1694	1100	107	2343	1520	139	3097	2000	175	3955	2570	220	4916	3200	269	5983	3910	321	7154	4700
	5	101	1133	738	135	1674	1079	174	2320	1498	219	3071	1978	270	3926	2544	337	4885	3174	403	5950	3880	475	7119	4662
	10	130	1105	710	172	1641	1045	220	2282	1460	273	3029	1940	334	3880	2500	413	4835	3130	489	5896	3830	573	7063	4600
	15	150	1078	688	195	1609	1018	248	2245	1425	306	2988	1910	372	3835	2465	459	4786	3090	541	5844	3795	631	7007	4575
	20	167	1052	665	217	1578	990	273	2210	1390	335	2948	1880	404	3791	2430	495	4737	3050	585	5792	3760	689	6953	4550
30	0	0	1977	1060	0	3004	1550	0	4252	2170	0	5725	2920	0	7420	3770	0	9341	4750	0	11483	5850	0	13848	7060
	2	54	1351	865	74	2004	1310	98	2786	1800	127	3696	2380	159	4734	3050	199	5900	3810	241	7194	4650	285	8617	5600
	5	96	1332	851	127	1981	1289	164	2759	1775	206	3666	2350	252	4701	3020	312	5863	3783	373	7155	4622	439	8574	5552
	10	125	1301	829	164	1944	1254	209	2716	1733	259	3617	2300	316	4647	2970	386	5803	3739	456	7090	4574	535	8505	5471
	15	143	1272	807	187	1908	1220	237	2674	1692	292	3570	2250	354	4594	2920	431	5744	3695	507	7026	4527	590	8437	5391
	20	160	1243	784	207	1873	1185	260	2633	1650	319	3523	2200	384	4542	2870	467	5686	3650	548	6964	4480	639	8370	5310
	30	195	1189	745	246	1807	1130	305	2555	1585	369	3433	2130	440	4442	2785	540	5574	3565	635	6842	4375	739	8239	5225
50	0	0	2231	1195	0	3441	1825	0	4934	2550	0	6711	3440	0	8774	4460	0	11129	5635	0	13767	6940	0	16694	8430
	2	41	1620	1010	66	2431	1513	86	3409	2125	113	4554	2840	141	5864	3670	171	7339	4630	209	8980	5695	251	10788	6860
	5	90	1600	996	118	2406	1495	151	3380	2102	191	4520	2813	234	5826	3639	283	7295	4597	336	8933	5654	394	10737	6818
	10	118	1567	972	154	2366	1466	196	3332	2064	243	4464	2767	295	5763	3585	355	7224	4542	419	8855	5585	491	10652	6749
	15	136	1536	948	177	2327	1437	222	3285	2026	274	4409	2721	330	5701	3534	396	7155	4511	465	8779	5546	542	10570	6710
	20	151	1505	924	195	2288	1408	244	3239	1987	300	4356	2675	361	5641	3481	433	7086	4479	506	8704	5506	586	10488	6670
	30	183	1446	876	232	2214	1349	287	3150	1910	347	4253	2631	412	5523	3431	494	6953	4421	577	8557	5444	672	10328	6603
100	0	0	2491	1310	0	3925	2050	0	5729	2950	0	7914	4050	0	10485	5300	0	13454	6700	0	16817	8600	0	20578	10300
	2	30	1975	1170	44	3027	1820	72	4313	2550	95	5834	3500	120	7591	4600	138	9577	5800	169	11803	7200	204	14264	8800
	5	82	1955	1159	107	3002	1803	136	4282	2531	172	5797	3475	208	7548	4566	245	9528	5769	293	11748	7162	341	14204	8756
	10	108	1923	1142	142	2961	1775	180	4231	2500	223	5737	3434	268	7478	4509	318	9447	5717	374	11658	7100	436	14105	8683
	15	126	1892	1124	163	2920	1747	206	4182	2469	252	5678	3392	304	7409	4451	358	9367	5665	418	11569	7037	487	14007	8610
	20	141	1861	1107	181	2880	1719	226	4133	2438	277	5619	3351	330	7341	4394	387	9289	5613	452	11482	6975	523	13910	8537
	30	170	1802	1071	215	2803	1663	265	4037	2375	319	5505	3267	378	7209	4279	446	9136	5509	514	11310	6850	592	13720	8391
	50	241	1688	1000	292	2657	1550	350	3856	2250	415	5289	3100	486	6956	4050	572	8841	5300	659	10979	6600	752	13354	8100

Table 5-10 Type B Double-Wall Vent

		Number of Appliances:												Single														
		Appliance Type:												Category I														
		Appliance Vent Connection:												Single-Wall Metal Connector														
		Vent Diameter — D (in.)																										
		3		4		5		6		7		8		9		10		12										
		Appliance Input Rating in Thousands of Btu per Hour																										
Height Lateral H L (ft) (ft)		FAN		NAT		FAN		NAT		FAN		NAT		FAN		NAT		FAN		NAT								
		Min	Max	Min	Max	Min	Max	Min	Max	Min	Max	Min	Max	Min	Max	Min	Max	Min	Max	Min	Max							
6	0	38	77	45	59	151	85	85	249	140	126	373	204	165	522	284	211	695	369	267	894	469	371	1118	569	537	1639	849
	2	39	51	36	60	96	66	85	156	104	123	231	156	159	320	213	201	423	284	251	541	368	347	673	453	498	979	648
	4	NANA	NANA	33	74	92	63	102	152	102	146	225	152	187	313	208	237	416	277	295	533	360	409	664	443	584	971	638
	6	NANA	NANA	31	83	89	60	114	147	99	163	220	148	207	307	203	263	409	271	327	526	352	449	656	433	638	962	627
8	0	37	83	50	58	164	93	83	273	154	123	412	234	161	580	319	206	777	414	258	1002	536	360	1257	658	521	1852	967
	2	39	56	39	59	108	75	83	176	119	121	261	179	155	363	246	197	482	321	246	617	417	339	768	513	486	1120	743
	5	NANA	NANA	37	77	102	69	107	168	114	151	252	171	193	352	235	245	470	311	305	604	404	418	754	560	598	1104	730
	8	NANA	NANA	33	90	95	64	122	161	107	175	243	163	223	342	225	280	458	300	344	591	392	470	740	486	665	1089	715
10	0	37	87	53	57	174	99	82	293	165	120	444	254	158	628	344	202	844	449	253	1093	584	351	1373	718	507	2031	1057
	2	39	61	41	59	117	80	82	193	128	119	287	194	153	400	272	193	531	354	242	681	456	332	849	559	475	1242	848
	5	52	56	39	76	111	76	105	185	122	148	277	186	190	388	261	241	518	344	299	667	443	409	834	544	584	1224	825
	10	NANA	NANA	34	97	100	68	132	171	112	188	261	171	237	369	241	296	497	325	363	643	423	492	808	520	688	1194	788
15	0	36	93	57	56	190	111	80	325	186	116	499	283	153	713	388	195	966	523	244	1259	681	336	1591	838	488	2374	1237
	2	38	69	47	57	136	93	80	225	149	115	337	224	148	473	314	187	631	413	232	812	543	319	1015	673	457	1491	983
	5	51	63	44	75	128	86	102	216	140	144	326	217	182	459	298	231	616	400	287	795	526	392	997	657	562	1469	963
	10	NANA	NANA	39	95	116	79	128	201	131	182	308	203	228	438	284	284	592	381	349	768	501	470	966	628	664	1433	928
	15	NANA	NANA	NA	NA	NA	72	158	186	124	220	290	192	272	418	269	334	568	367	404	742	484	540	937	601	750	1399	894
20	0	35	96	60	54	200	118	78	346	201	114	537	306	149	772	428	190	1053	573	238	1379	750	326	1751	927	473	2631	1346
	2	37	74	50	56	148	99	78	248	165	113	375	248	144	528	344	182	708	468	227	914	611	309	1146	734	443	1689	1098
	5	50	68	47	73	140	94	100	239	158	141	363	239	178	514	334	224	692	457	279	896	596	381	1126	734	547	1665	1074
	10	NANA	NANA	41	93	129	86	125	223	146	177	344	224	222	491	316	277	666	437	339	866	570	457	1092	702	646	1626	1037
	15	NANA	NANA	NA	NA	NA	80	155	208	136	216	325	210	264	469	301	325	640	419	393	838	549	526	1060	677	730	1587	1005
20	NANA	NANA	NA	NA	NA	NA	186	192	126	254	306	196	309	448	285	374	616	400	448	810	526	592	1028	651	808	1550	973	
30	0	34	99	63	53	211	127	76	372	219	110	584	334	144	849	472	184	1168	647	229	1542	852	312	1971	1056	454	2996	1545
	2	37	80	56	55	164	111	76	281	183	109	429	279	139	610	392	175	823	533	219	1069	698	296	1346	863	424	1999	1308
	5	49	74	52	72	157	106	98	271	173	136	417	271	171	595	382	215	806	521	269	1049	684	366	1324	846	524	1971	1283
	10	NANA	NANA	NA	91	144	98	122	255	168	171	397	257	213	570	367	265	777	501	327	1017	662	440	1287	821	620	1927	1243
	15	NANA	NANA	NA	115	131	NA	151	239	157	208	377	242	255	547	349	312	750	481	379	985	636	507	1251	794	702	1884	1205
	20	NANA	NANA	NA	NA	NA	NA	181	223	NA	246	357	228	298	524	333	360	723	461	433	955	615	570	1216	768	780	1841	1166
	30	NANA	NANA	NA	NA	NA	NA	NA	NA	NA	NA	NA	NA	NA	389	477	305	461	670	426	541	895	574	704	1147	720	937	1759
50	0	33	99	66	51	213	133	73	394	230	105	629	361	138	928	515	176	1292	704	220	1724	948	295	2223	1189	428	3432	1818
	2	36	84	61	53	181	121	73	318	205	104	495	312	133	712	443	168	971	613	209	1273	811	280	1615	1007	401	2426	1509
	5	48	80	NA	70	174	117	94	308	198	131	482	305	164	696	435	204	953	602	257	1252	795	347	1591	991	496	2396	1490
	10	NANA	NANA	NA	89	160	NA	118	292	186	162	461	292	203	671	420	253	923	583	313	1217	765	418	1551	963	589	2347	1455
	15	NANA	NANA	NA	112	148	NA	145	275	174	199	441	280	244	646	405	299	894	562	363	1183	736	481	1512	934	668	2299	1421
	20	NANA	NANA	NA	NA	NA	NA	176	257	NA	236	420	267	285	622	389	345	866	543	415	1150	708	544	1473	906	741	2251	1387
30	NANA	NANA	NA	NA	NA	NA	NA	NA	NA	315	376	NA	373	573	NA	442	809	502	521	1086	649	674	1399	848	892	2159	1318	
100	0	NANA	NANA	NA	49	214	NA	69	403	NA	100	659	395	131	991	585	166	1404	765	207	1900	1033	273	2479	1300	395	3912	2042
	2	NANA	NANA	NA	51	192	NA	70	351	NA	98	563	373	125	828	508	158	1152	698	196	1532	933	259	1970	1168	371	3021	1817
	5	NANA	NANA	NA	67	186	NA	90	342	NA	125	551	366	156	813	501	194	1134	688	240	1511	921	322	1945	1153	460	2990	1796
	10	NANA	NANA	NA	85	175	NA	113	324	NA	153	532	354	191	789	486	238	1104	672	293	1477	902	389	1905	1133	547	2938	1763
	15	NANA	NANA	NA	132	162	NA	138	310	NA	188	511	343	230	764	473	281	1075	656	342	1443	884	447	1865	1110	618	2888	1730
	20	NANA	NANA	NA	NA	NA	NA	168	295	NA	224	487	NA	270	739	458	325	1046	639	391	1410	864	507	1825	1087	690	2838	1696
	30	NANA	NANA	NA	NA	NA	NA	231	264	NA	301	448	NA	355	685	NA	418	988	NA	491	1343	824	631	1747	1041	834	2739	1627
	50	NANA	NANA	NA	NA	NA	NA	NA	NA	NA	NA	NA	NA	540	584	NA	617	866	NA	711	1205	NA	138	1591	NA	1138	2547	1489

Table 5-11 Masonry Chimney

		Number of Appliances:												Single															
		Appliance Type:												Category I															
		Appliance Vent Connection:												Type B Double-Wall Connector															
		Type B Double-Wall Connector Diameter — D (in.)																											
		To be used with chimney areas within the size limits at bottom																											
		Appliance Input Rating in Thousands of Btu per Hour																											
Height Lateral H	L	FAN		NAT		FAN		NAT		FAN		NAT		FAN		NAT		FAN		NAT		FAN		NAT					
		Min	Max	Min	Max	Min	Max	Min	Max	Min	Max	Min	Max	Min	Max	Min	Max	Min	Max	Min	Max	Min	Max	Min	Max				
(ft)	(ft)	NA	NA	28	NA	NA	52	NA	NA	86	NA	NA	130	NA	NA	180	NA	NA	247	NA	NA	320	NA	NA	401	NA	NA	581	
	5	NA	NA	25	NA	NA	49	NA	NA	82	NA	NA	117	NA	NA	165	NA	NA	231	NA	NA	298	NA	NA	376	NA	NA	561	
	8	NA	NA	29	NA	NA	55	NA	NA	93	NA	NA	145	NA	NA	198	NA	NA	266	84	590	350	100	728	446	139	1024	651	
	5	NA	NA	26	NA	NA	52	NA	NA	85	NA	NA	134	NA	NA	183	NA	NA	247	NA	NA	328	149	711	423	201	1007	640	
	8	NA	NA	24	NA	NA	48	NA	NA	83	NA	NA	127	NA	NA	175	NA	NA	239	NA	NA	318	173	695	410	231	990	623	
	10	NA	NA	31	NA	NA	61	NA	NA	103	NA	NA	162	NA	NA	221	68	519	298	82	655	388	98	810	491	136	1144	724	
	5	NA	NA	28	NA	NA	57	NA	NA	96	NA	NA	148	NA	NA	204	NA	NA	277	124	638	365	146	791	466	196	1124	712	
	10	NA	NA	25	NA	NA	50	NA	NA	87	NA	NA	139	NA	NA	191	NA	NA	263	155	610	347	182	762	444	240	1093	668	
	15	NA	NA	35	NA	NA	67	NA	NA	114	NA	NA	179	53	475	250	64	613	336	77	779	441	92	968	562	127	1376	841	
	5	NA	NA	35	NA	NA	62	NA	NA	107	NA	NA	164	NA	NA	231	99	594	313	118	759	416	139	946	533	186	1352	828	
	10	NA	NA	28	NA	NA	55	NA	NA	97	NA	NA	153	NA	NA	216	126	565	296	148	727	394	173	912	567	229	1315	777	
	15	NA	NA	NA	NA	NA	48	NA	NA	89	NA	NA	141	NA	NA	201	NA	NA	281	171	698	375	198	880	485	259	1280	742	
	20	NA	NA	38	NA	NA	74	NA	NA	124	NA	NA	201	51	522	274	61	678	375	73	867	491	87	1083	627	121	1548	953	
	5	NA	NA	36	NA	NA	68	NA	NA	116	NA	NA	184	80	503	254	95	658	350	113	845	463	133	1059	597	179	1523	933	
	10	NA	NA	NA	NA	NA	60	NA	NA	107	NA	NA	172	NA	NA	237	122	627	332	143	811	440	167	1022	566	221	1482	879	
	15	NA	NA	NA	NA	NA	NA	NA	NA	97	NA	NA	159	NA	NA	220	NA	NA	314	165	780	418	191	987	541	251	1443	840	
	20	NA	NA	NA	NA	NA	NA	NA	NA	83	NA	NA	148	NA	NA	206	NA	NA	296	186	750	397	214	955	513	277	1406	807	
	30	NA	NA	41	NA	NA	82	NA	NA	137	NA	NA	216	47	581	303	57	762	421	68	985	558	81	1240	717	111	1793	1112	
	5	NA	NA	NA	NA	NA	76	NA	NA	128	NA	NA	198	75	561	281	90	741	393	106	962	526	125	1216	683	169	1766	1094	
	10	NA	NA	NA	NA	NA	67	NA	NA	115	NA	NA	184	NA	NA	263	115	709	373	135	927	500	158	1176	648	210	1721	1025	
	15	NA	NA	NA	NA	NA	NA	NA	NA	107	NA	NA	171	NA	NA	243	NA	NA	353	156	893	476	181	1139	621	239	1679	981	
	20	NA	NA	NA	NA	NA	NA	NA	NA	91	NA	NA	159	NA	NA	227	NA	NA	332	176	860	450	203	1103	592	264	1638	940	
	30	NA	NA	NA	NA	NA	NA	NA	NA	NA	NA	NA	NA	NA	NA	188	NA	NA	288	NA	NA	416	249	1035	555	318	1560	877	
	50	NA	NA	NA	NA	NA	92	NA	NA	161	NA	NA	251	NA	NA	351	51	840	477	61	1106	633	72	1413	812	99	2080	1243	
	5	NA	NA	NA	NA	NA	NA	NA	NA	151	NA	NA	230	NA	NA	323	83	819	445	98	1083	596	116	1387	774	155	2052	1225	
	10	NA	NA	NA	NA	NA	NA	NA	NA	138	NA	NA	215	NA	NA	304	NA	NA	424	126	1047	567	147	1347	733	195	2006	1147	
	15	NA	NA	NA	NA	NA	NA	NA	NA	127	NA	NA	199	NA	NA	282	NA	NA	400	146	1010	539	170	1307	702	222	1961	1099	
	20	NA	NA	NA	NA	NA	NA	NA	NA	NA	NA	NA	185	NA	NA	264	NA	NA	376	165	977	511	190	1269	669	246	1916	1050	
	30	NA	NA	NA	NA	NA	NA	NA	NA	NA	NA	NA	NA	NA	NA	NA	NA	NA	327	NA	NA	468	233	1196	623	295	1832	984	
Minimum Internal Area of Chimney Square Inches		12		19		28		38		50		63		78		95		132											
Minimum Internal Area of Chimney Square Inches		49		88		137		198		269		352		445		550		792											

Table 5-12 Masonry Chimney

		Number of Appliances:												Single																			
		Appliance Type:												Category I																			
		Appliance Vent Connection:												Single-Wall Metal Connector																			
		Single-Wall Metal Connector Diameter — D (in.) To be used with chimney areas within the size limits at bottom																															
		3			4			5			6			7			8			9			10			12							
		Appliance Input Rating in Thousands of Btu per Hour																															
Height (ft.)	Lateral (ft.)	FAN		NAT		FAN		NAT		FAN		NAT		FAN		NAT		FAN		NAT		FAN		NAT		FAN		NAT		FAN		NAT	
		Min	Max	Min	Max	Min	Max	Min	Max	Min	Max	Min	Max	Min	Max	Min	Max	Min	Max	Min	Max	Min	Max	Min	Max	Min	Max	Min	Max	Min	Max	Min	Max
6	2	NA	NA	28	NA	NA	52	NA	NA	86	NA	NA	130	NA	NA	180	NA	NA	247	NA	NA	319	NA	NA	400	NA	NA	580					
	5	NA	NA	25	NA	NA	48	NA	NA	81	NA	NA	116	NA	NA	164	NA	NA	230	NA	NA	297	NA	NA	375	NA	NA	560					
8	2	NA	NA	29	NA	NA	55	NA	NA	93	NA	NA	145	NA	NA	197	NA	NA	265	NA	NA	349	382	725	445	549	1021	650					
	5	NA	NA	26	NA	NA	51	NA	NA	87	NA	NA	133	NA	NA	182	NA	NA	246	NA	NA	327	NA	NA	422	673	1003	638					
	8	NA	NA	23	NA	NA	47	NA	NA	82	NA	NA	126	NA	NA	174	NA	NA	237	NA	NA	317	NA	NA	408	747	985	621					
10	2	NA	NA	31	NA	NA	61	NA	NA	102	NA	NA	161	NA	NA	220	216	518	297	271	654	387	373	808	490	536	1142	722					
	5	NA	NA	28	NA	NA	56	NA	NA	95	NA	NA	147	NA	NA	203	NA	NA	276	334	635	364	459	789	465	657	1121	710					
	10	NA	NA	24	NA	NA	49	NA	NA	86	NA	NA	137	NA	NA	189	NA	NA	261	NA	NA	345	547	758	441	771	1088	665					
15	2	NA	NA	35	NA	NA	67	NA	NA	113	NA	NA	178	166	473	249	211	611	335	264	776	440	362	965	560	520	1373	840					
	5	NA	NA	32	NA	NA	61	NA	NA	106	NA	NA	163	NA	NA	230	261	591	312	325	755	414	444	942	531	637	1348	825					
	10	NA	NA	27	NA	NA	54	NA	NA	96	NA	NA	151	NA	NA	214	NA	NA	294	392	722	392	531	907	504	749	1309	774					
20	15	NA	NA	NA	NA	NA	46	NA	NA	87	NA	NA	138	NA	NA	198	NA	NA	278	452	692	372	606	873	481	841	1272	738					
	2	NA	NA	38	NA	NA	73	NA	NA	123	NA	NA	200	163	520	273	206	675	374	258	864	490	252	1079	625	508	1544	950					
	5	NA	NA	35	NA	NA	67	NA	NA	115	NA	NA	183	NA	NA	252	255	655	348	317	842	461	433	1055	594	623	1518	930					
	10	NA	NA	NA	NA	NA	59	NA	NA	105	NA	NA	170	NA	NA	235	312	622	330	382	806	437	517	1016	562	733	1475	875					
30	15	NA	NA	NA	NA	NA	95	NA	NA	158	NA	NA	217	NA	NA	292	NA	NA	311	442	773	414	591	979	539	823	1434	835					
	20	NA	NA	NA	NA	NA	80	NA	NA	123	NA	NA	144	NA	NA	202	NA	NA	292	NA	NA	392	663	944	510	911	1394	800					
	2	NA	NA	41	NA	NA	81	NA	NA	136	NA	NA	215	158	578	302	200	759	420	249	982	556	340	1237	715	489	1789	1110					
	5	NA	NA	NA	NA	NA	75	NA	NA	127	NA	NA	196	NA	NA	279	245	737	391	306	958	524	417	1210	680	600	1760	1090					
	10	NA	NA	NA	NA	NA	66	NA	NA	113	NA	NA	182	NA	NA	260	300	703	370	370	920	496	500	1168	644	708	1713	1020					
50	15	NA	NA	NA	NA	NA	105	NA	NA	168	NA	NA	240	NA	NA	349	NA	NA	349	428	884	471	572	1128	615	798	1668	975					
	20	NA	NA	NA	NA	NA	88	NA	NA	136	NA	NA	188	NA	NA	258	NA	NA	327	NA	NA	445	643	1089	585	883	1624	932					
	30	NA	NA	NA	NA	NA	NA	NA	NA	NA	NA	NA	NA	NA	NA	NA	NA	NA	281	NA	NA	408	NA	NA	544	1055	1539	865					
	2	NA	NA	NA	NA	NA	91	NA	NA	160	NA	NA	250	NA	NA	350	191	837	475	238	1103	631	323	1408	810	463	2076	1240					
	5	NA	NA	NA	NA	NA	149	NA	NA	228	NA	NA	321	NA	NA	442	NA	NA	442	293	1078	593	398	1381	770	571	2044	1220					
Minimum Internal Area of Chimney Square Inches		12			19			28			38			50			63			78			95			132							
		49			88			137			198			269			352			445			550			792							
		Maximum Internal Area of Chimney Square Inches																															

Table 5-13 Single-Wall Metal Pipe or Type B Asbestos Cement Vent

		Number of Appliances:		Single					
		Appliance Type:		Category I					
		Appliance Vent Connection:		Connected Directly to Vent					
Single-Wall Metal Connector Diameter - D (in.) To be used with chimney area within the size limits at bottom									
Height H (ft.)	Lateral L (ft.)	3	4	5	6	7	8	10	12
		Appliance Input Rating in Thousands of Btu per Hour							
		Maximum Appliance Input Rating in Thousands of Btu per Hour							
6	0	39	70	116	170	232	312	500	750
	2	31	55	94	141	194	260	415	620
	5	28	51	88	128	177	242	390	600
8	0	42	76	126	185	252	340	542	815
	2	32	61	102	154	210	284	451	680
	5	29	56	95	141	194	264	430	648
	10	24	49	86	131	180	250	406	625
10	0	45	84	138	202	279	372	606	912
	2	35	67	111	168	233	311	505	760
	5	32	61	104	153	215	289	480	724
	10	27	54	94	143	200	274	455	700
	15	NA	46	84	130	186	258	432	666
15	0	49	91	151	223	312	420	684	1040
	2	39	72	122	186	260	350	570	865
	5	35	67	110	170	240	325	540	825
	10	30	58	103	158	223	308	514	795
	15	NA	50	93	144	207	291	488	760
	20	NA	NA	82	132	195	273	466	726
20	0	53	101	163	252	342	470	770	1190
	2	42	80	136	210	286	392	641	990
	5	38	74	123	192	264	364	610	945
	10	32	65	115	178	246	345	571	910
	15	NA	55	104	163	228	326	550	870
	20	NA	NA	91	149	214	306	525	832
30	0	56	108	183	276	384	529	878	1370
	2	44	84	148	230	320	441	730	1140
	5	NA	78	137	210	296	410	694	1080
	10	NA	68	125	196	274	388	656	1050
	15	NA	NA	113	177	258	366	625	1000
	20	NA	NA	99	163	240	344	596	960
	30	NA	NA	NA	NA	192	295	540	890
50	0	NA	120	210	310	443	590	980	1550
	2	NA	95	171	260	370	492	820	1290
	5	NA	NA	159	234	342	474	780	1230
	10	NA	NA	146	221	318	456	730	1190
	15	NA	NA	NA	200	292	407	705	1130
	20	NA	NA	NA	185	276	384	670	1080
	30	NA	NA	NA	NA	222	330	605	10



Table 5-14 Type B Double-Wall Vent

<b>Number of Appliances:</b>	<b>Two or More</b>
<b>Appliance Type:</b>	<b>Category I</b>
<b>Appliance Vent Connection:</b>	<b>Type B Double-Wall Connector</b>

		Type B Double-Wall Vent and Connector Diameter — D (in.)																											
		3			4			5			6			7			8			9			10						
		Appliance Input Rating in Thousands of Btu per Hour																											
Height Rise H R (ft.)	FAN NAT	FAN		NAT		FAN		NAT		FAN		NAT		FAN		NAT		FAN		NAT		FAN		NAT		FAN		NAT	
		Min	Max	Max	Min	Max	Max	Min	Max	Max	Min	Max	Max	Min	Max	Max	Min	Max	Max	Min	Max	Max	Min	Max	Max	Min	Max	Max	Min
6	1	22	37	26	35	66	46	46	106	72	58	164	104	77	225	142	92	296	185	109	376	237	128	466	289				
	2	23	41	31	37	75	55	48	121	86	60	183	124	79	253	168	95	333	220	112	424	282	131	526	345				
	3	24	44	35	38	81	62	49	132	96	62	199	139	82	275	189	97	363	248	114	463	317	134	575	386				
8	1	22	40	27	35	72	48	49	114	76	64	176	109	84	243	148	100	320	194	118	408	248	138	507	303				
	2	23	44	32	36	80	57	51	128	90	66	195	129	86	269	175	103	356	230	121	454	294	141	564	358				
	3	24	47	36	37	87	64	53	139	101	67	210	145	88	290	198	105	384	258	123	492	330	143	612	402				
10	1	22	43	28	34	78	50	49	123	78	65	189	113	89	257	154	106	341	200	125	436	257	146	542	314				
	2	23	47	33	36	86	59	51	136	93	67	206	134	91	282	182	109	374	238	128	479	305	149	596	372				
	3	24	50	37	37	92	67	52	146	104	69	220	150	94	303	205	111	402	268	131	515	342	152	642	417				
15	1	21	50	30	33	89	53	47	142	83	64	220	120	88	298	163	110	389	214	134	493	273	162	609	333				
	2	22	53	35	35	96	63	49	153	99	66	235	142	91	320	193	112	419	253	137	532	323	165	658	394				
	3	24	55	40	36	102	71	51	163	111	68	248	160	93	339	218	115	445	286	140	565	365	167	700	444				
20	1	21	54	31	33	99	56	46	157	87	62	246	125	86	334	171	107	436	224	131	552	285	158	681	347				
	2	22	57	37	34	105	66	48	167	104	64	259	149	89	354	202	110	463	265	134	587	339	161	725	414				
	3	23	60	42	35	110	74	50	176	116	66	271	168	91	371	228	113	486	300	137	618	383	164	764	466				
30	1	20	62	33	31	113	59	45	181	93	60	288	134	83	391	182	103	512	238	125	649	305	151	802	372				
	2	21	64	39	33	118	70	47	190	110	62	299	158	85	408	215	105	535	282	129	679	360	155	840	439				
	3	22	66	44	34	123	79	48	198	124	64	309	178	88	423	242	108	555	317	132	706	405	158	874	494				
50	1	19	71	36	30	133	64	43	216	101	57	349	145	78	477	197	97	627	257	120	797	330	144	984	403				
	2	21	73	43	32	137	76	45	223	119	59	358	172	81	490	234	100	645	306	123	820	392	148	1014	478				
	3	22	75	48	33	141	86	46	229	134	61	366	194	83	502	263	103	661	343	126	842	441	151	1043	538				
100	1	18	82	37	28	158	66	40	262	104	53	442	150	73	611	204	91	810	266	112	1038	341	135	1285	417				
	2	19	83	44	30	161	79	42	267	123	55	447	178	75	619	242	94	822	316	115	1054	405	139	1306	494				
	3	20	84	50	31	163	89	44	272	138	57	452	200	78	627	272	97	834	355	118	1069	455	142	1327	555				

Common Vent Capacity

		Type B Double-Wall Common Vent Diameter — D (in.)																											
		4			5			6			7			8			9			10									
		Combined Appliance Input Rating in Thousands of Btu per Hour																											
Vent Height H (ft.)	FAN NAT	FAN		NAT		FAN		NAT		FAN		NAT		FAN		NAT		FAN		NAT		FAN		NAT		FAN		NAT	
		+FAN	+NAT	+NAT	+FAN	+NAT	+NAT	+FAN	+NAT	+NAT	+FAN	+NAT	+NAT	+FAN	+NAT	+NAT	+FAN	+NAT	+NAT	+FAN	+NAT	+NAT	+FAN	+NAT	+NAT	+FAN	+NAT	+NAT	+FAN
6		92	81	65	140	116	103	204	161	147	309	248	200	404	314	260	547	434	335	672	520	410							
8		101	90	73	155	129	114	224	178	163	339	275	223	444	348	290	602	480	378	740	577	465							
10		110	97	79	169	141	124	243	194	178	367	299	242	477	377	315	649	522	405	800	627	495							
15		125	112	91	195	164	144	283	228	206	427	352	280	556	444	365	753	612	465	924	733	565							
20		136	123	102	215	183	160	314	255	229	475	394	310	621	499	405	842	688	523	1035	826	640							
30		152	138	118	244	210	185	361	297	266	547	459	360	720	585	470	979	808	605	1209	975	740							
50		167	153	134	279	244	214	421	353	310	641	547	423	854	706	550	1164	977	705	1451	1188	860							
100		175	163	NA	311	277	NA	489	421	NA	751	658	479	1025	873	625	1408	1215	800	1784	1502	975							

Table 5-14 Continued

		Number of Appliances:			Two or More																				
		Appliance Type:			Category I																				
		Appliance Vent Connection:			Type B Double-Wall Vent Connector																				
		Type B Double-Wall Vent Connector Diameter – D (in.)																							
		12			14			16			18			20			22			24					
		Appliance Input Rating Limits in Thousands of Btu per Hour																							
Vent Connector Height H (ft.)	Rise R (ft.)	FAN			NAT			FAN			NAT			FAN			NAT			FAN			NAT		
		Min	Max	Max	Min	Max	Max	Min	Max	Max	Min	Max	Max	Min	Max	Max	Min	Max	Max	Min	Max	Max	Min	Max	Max
6	2	174	764	496	223	1046	653	281	1371	853	346	1772	1080	NA	NA	NA	NA	NA	NA	NA	NA	NA	NA	NA	NA
	4	180	897	616	230	1231	827	287	1617	1081	352	2069	1370	NA	NA	NA	NA	NA	NA	NA	NA	NA	NA	NA	NA
	6	NA	NA	NA	NA	NA	NA	NA	NA	NA	NA	NA	NA	NA	NA	NA	NA	NA	NA	NA	NA	NA	NA	NA	NA
8	2	186	822	516	238	1126	696	298	1478	910	365	1920	1150	NA	NA	NA	NA	NA	NA	NA	NA	NA	NA	NA	NA
	4	192	952	644	244	1307	884	305	1719	1150	372	2211	1460	471	2737	1800	560	3319	2180	662	3957	2590			
	6	198	1050	772	252	1445	1072	313	1902	1390	380	2434	1770	478	3018	2180	568	3665	2640	669	4373	3130			
10	2	196	870	536	249	1195	730	311	1570	955	379	2049	1205	NA	NA	NA	NA	NA	NA	NA	NA	NA	NA	NA	
	4	201	997	664	256	1371	924	318	1804	1205	387	2332	1535	486	2887	1890	581	3502	2280	686	4175	2710			
	6	207	1095	792	263	1509	1118	325	1989	1455	395	2556	1865	494	3169	2290	589	3849	2760	694	4593	3270			
15	2	214	967	568	272	1334	790	336	1760	1030	408	2317	1305	NA	NA	NA	NA	NA	NA	NA	NA	NA	NA	NA	
	4	221	1085	712	279	1499	1006	344	1978	1320	416	2579	1665	523	3197	2060	624	3881	2490	734	4631	2960			
	6	228	1181	856	286	1632	1222	351	2157	1610	424	2796	2025	533	3470	2510	634	4216	3030	743	5035	3600			
20	2	223	1051	596	291	1443	840	357	1911	1095	430	2533	1385	NA	NA	NA	NA	NA	NA	NA	NA	NA	NA	NA	
	4	230	1162	748	298	1597	1064	365	2116	1395	438	2778	1765	554	3447	2180	661	4190	2630	772	5005	3130			
	6	237	1253	900	307	1726	1288	373	2287	1695	450	2984	2145	567	3708	2650	671	4511	3190	785	5392	3790			
30	2	216	1217	632	286	1664	910	367	2183	1190	461	2891	1540	NA	NA	NA	NA	NA	NA	NA	NA	NA	NA	NA	
	4	223	1316	792	294	1802	1160	376	2366	1510	474	3110	1920	619	3840	2365	728	4861	2860	847	5606	3410			
	6	231	1400	952	303	1920	1410	384	2524	1830	485	3299	2340	632	4080	2875	741	4976	3480	860	5961	4150			
50	2	206	1479	689	273	2023	1007	350	2659	1315	435	3548	1665	NA	NA	NA	NA	NA	NA	NA	NA	NA	NA	NA	
	4	213	1561	860	281	2139	1291	359	2814	1685	447	3730	2135	580	4601	2633	709	5569	3185	851	6633	3790			
	6	221	1631	1031	290	2242	1575	369	2951	2055	461	3893	2605	594	4808	3208	724	5826	3885	867	6943	4620			
100	2	192	1923	712	254	2644	1050	326	3490	1370	402	4707	1740	NA	NA	NA	NA	NA	NA	NA	NA	NA	NA	NA	
	4	200	1984	888	263	2731	1346	336	3606	1760	414	4842	2220	523	5982	2750	639	7254	3330	769	8650	3950			
	6	208	2035	1064	272	2811	1642	346	3714	2150	426	4968	2700	539	6143	3350	654	7453	4070	786	8892	4810			

Common Vent Capacity

		Type B Double-Wall Common Vent Diameter — D (in.)																							
		12			14			16			18			20			22			24					
		Combined Appliance Input Rating in Thousands of Btu per Hour																							
Vent Height H (ft.)	Rise R (ft.)	FAN			NAT			FAN			NAT			FAN			NAT			FAN			NAT		
		+FAN	+NAT	+NAT	+FAN	+NAT	+NAT	+FAN	+NAT	+NAT	+FAN	+NAT	+NAT	+FAN	+NAT	+NAT	+FAN	+NAT	+NAT	+FAN	+NAT	+NAT			
6		900	696	588	1284	990	815	1735	1336	1065	2253	1732	1345	2838	2180	1660	3488	2677	1970	4206	3226	2390			
8		994	773	652	1423	1103	912	1927	1491	1190	2507	1936	1510	3162	2439	1860	3890	2998	2200	4695	3616	2680			
10		1076	841	712	1542	1200	995	2093	1625	1300	2727	2113	1645	3444	2665	2030	4241	3278	2400	5123	3957	2920			
15		1247	986	825	1794	1410	1158	2440	1910	1510	3184	2484	1910	4026	3133	2360	4971	3862	2790	6016	4670	3400			
20		1405	1116	916	2006	1588	1290	2722	2147	1690	3561	2798	2140	4548	3552	2640	5573	4352	3120	6749	5261	3800			
30		1658	1327	1025	2373	1892	1525	3220	2558	1990	4197	3326	2520	5303	4193	3110	6539	5157	3680	7940	6247	4480			
50		2024	1640	1280	2911	2347	1863	3964	3183	2430	5184	4149	3075	6567	5240	3800	8116	6458	4500	9837	7813	5475			
100		2569	2131	1670	3732	3076	2450	5125	4202	3200	6749	5509	4050	8597	6986	5000	10681	8648	5920	13004	10499	7200			



Table 5-15 Type B Double-Wall Vent

		Number of Appliances:		Two or More																									
		Appliance Type:		Category I																									
		Appliance Vent Connection:		Single-Wall Metal Connector																									
		Vent Connector Capacity																											
		Single-Wall Metal Vent Connector Diameter — D (in.)																											
		3			4			5			6			7			8			9			10						
		Appliance Input Rating Limits in Thousands of Btu per Hour																											
Vent Connector Height Rise	H (ft)	R (ft)	FAN		NAT	FAN		NAT	FAN		NAT	FAN		NAT	FAN		NAT	FAN		NAT	FAN		NAT	FAN		NAT	FAN		NAT
			Min	Max	Max	Min	Max	Max	Min	Max	Max	Min	Max	Max	Min	Max	Max	Min	Max	Max	Min	Max	Max	Min	Max	Max	Min	Max	Max
6	1	NA	NA	26	NA	NA	46	NA	NA	71	NA	NA	102	207	223	140	262	293	183	325	373	234	447	463	286	447	463	286	
	2	NA	NA	31	NA	NA	55	NA	NA	85	168	182	123	215	251	167	271	331	219	334	422	281	458	524	344	458	524	344	
	3	NA	NA	34	NA	NA	62	121	131	95	175	198	138	222	273	188	279	361	247	344	462	316	468	574	385	468	574	385	
8	1	NA	NA	27	NA	NA	48	NA	NA	75	NA	NA	106	226	240	145	285	316	191	352	403	244	481	502	299	481	502	299	
	2	NA	NA	32	NA	NA	57	125	126	89	184	193	127	234	266	173	293	353	228	360	450	292	492	560	355	492	560	355	
	3	NA	NA	35	NA	NA	64	130	138	100	191	208	144	241	287	197	302	381	256	370	489	328	501	609	400	501	609	400	
10	1	NA	NA	28	NA	NA	50	119	121	77	182	186	110	240	253	150	302	335	196	372	429	252	506	534	308	506	534	308	
	2	NA	NA	33	84	85	59	124	134	91	189	203	132	248	278	183	311	369	235	381	473	302	517	589	368	517	589	368	
	3	NA	NA	36	89	91	67	129	144	102	197	217	148	257	299	203	320	398	265	391	511	339	528	637	413	528	637	413	
15	1	NA	NA	29	79	87	52	116	138	81	177	214	116	238	291	158	312	380	208	397	482	266	556	596	324	556	596	324	
	2	NA	NA	34	83	94	62	121	150	97	185	230	138	246	314	189	321	411	248	407	522	317	568	646	387	568	646	387	
	3	NA	NA	39	87	100	70	127	160	109	193	243	157	255	333	215	331	438	281	418	557	360	579	690	437	579	690	437	
20	1	49	56	30	78	97	54	115	152	84	175	238	120	233	325	165	306	425	217	390	538	276	546	664	336	546	664	336	
	2	52	59	36	82	103	64	120	163	101	182	252	144	243	346	197	317	453	259	400	574	331	558	709	403	558	709	403	
	3	55	62	40	87	107	72	125	172	113	190	264	164	252	363	223	326	476	294	412	607	375	570	750	457	570	750	457	
30	1	47	60	31	77	110	57	112	175	89	169	278	129	226	380	175	296	497	230	378	630	294	528	779	358	528	779	358	
	2	51	62	37	81	115	67	117	185	106	177	290	152	236	397	208	307	521	274	389	662	349	541	819	425	541	819	425	
	3	54	64	42	85	119	76	122	193	120	185	300	172	244	412	235	316	542	309	400	690	394	555	855	482	555	855	482	
50	1	46	69	34	75	128	60	109	207	96	162	336	137	217	460	188	284	604	245	364	768	314	507	951	384	507	951	384	
	2	49	71	40	79	132	72	114	215	113	170	345	164	226	473	223	294	623	293	376	793	375	520	983	458	520	983	458	
	3	52	72	45	83	136	82	119	221	123	178	353	186	235	486	252	304	640	331	387	816	423	535	1013	518	535	1013	518	
100	1	45	79	34	71	150	61	104	249	98	153	424	140	205	585	192	269	774	249	345	993	321	476	1236	393	476	1236	393	
	2	48	80	41	75	153	73	110	255	115	160	428	167	212	593	228	279	788	299	358	1011	383	490	1259	469	490	1259	469	
	3	51	81	46	79	157	85	114	260	129	168	433	190	222	603	256	289	801	339	368	1027	431	506	1280	527	506	1280	527	

Common Vent Capacity

		Type B Double-Wall Vent Diameter — D (in.)																										
		4			5			6			7			8			9			10								
		Combined Appliance Input Rating in Thousands of Btu per Hour																										
Vent Height	H (ft)	FAN	FAN	NAT	FAN	FAN	NAT	FAN	FAN	NAT	FAN	FAN	NAT	FAN	FAN	NAT	FAN	FAN	NAT	FAN	FAN	NAT	FAN	FAN	NAT	FAN	FAN	NAT
		+FAN+NAT	+FAN+NAT	+NAT	+FAN+NAT	+FAN+NAT	+NAT	+FAN+NAT	+FAN+NAT	+NAT	+FAN+NAT	+FAN+NAT	+NAT	+FAN+NAT	+FAN+NAT	+NAT	+FAN+NAT	+FAN+NAT	+NAT	+FAN+NAT	+FAN+NAT	+NAT	+FAN+NAT	+FAN+NAT	+NAT	+FAN+NAT	+FAN+NAT	+NAT
6	NA	78	64	NA	113	99	200	158	144	304	244	196	398	310	257	541	429	332	665	515	407							
8	NA	87	71	NA	126	111	218	173	159	331	269	218	436	342	285	592	473	373	730	569	460							
10	NA	94	76	163	137	120	237	189	174	357	292	236	467	369	309	638	512	398	787	617	487							
15	121	108	88	189	159	140	275	221	200	416	343	274	544	434	357	738	599	456	905	718	553							
20	131	118	98	208	177	156	305	247	223	463	383	302	606	487	395	824	673	512	1013	808	626							
30	145	132	113	236	202	180	350	286	257	533	446	349	703	570	459	958	790	593	1183	952	723							
50	159	145	128	268	233	208	406	337	296	622	529	410	833	686	535	1139	954	689	1418	1157	838							
100	166	153	NA	297	263	NA	469	398	NA	726	633	464	999	846	606	1378	1185	780	1741	1459	948							

Table 5-16 Masonry Chimney

		Number of Appliances:			Two or More																													
		Appliance Type:			Category I																													
		Appliance Vent Connection:			Type B Double-Wall Connector																													
Vent Connector Capacity																																		
Type B Double-Wall Vent Connector Diameter — D (in.)																																		
Vent Connector Height Rise		3		4		5		6		7		8		9		10																		
		Appliance Input Rating Limits in Thousands of Btu per Hour																																
H	R	FAN			NAT			FAN			NAT			FAN			NAT			FAN			NAT			FAN			NAT					
(ft.)	(ft.)	Min	Max	Max	Min	Max	Max	Min	Max	Max	Min	Max	Max	Min	Max	Max	Min	Max	Max	Min	Max	Max	Min	Max	Max	Min	Max	Max	Min	Max	Max	Min	Max	Max
6	1	24	33	21	39	62	40	52	106	67	65	194	101	87	274	141	104	370	201	124	479	253	145	599	319									
	2	26	43	28	41	79	52	53	133	85	67	230	124	89	324	173	107	436	232	127	562	300	148	694	378									
	3	27	49	34	42	92	61	55	155	97	69	262	143	91	369	203	109	491	270	129	633	349	151	795	439									
8	1	24	39	22	39	72	41	55	117	69	71	213	105	94	304	148	113	414	210	134	539	267	156	682	335									
	2	26	47	29	40	87	53	57	140	86	73	246	127	97	350	179	116	473	240	137	615	311	160	776	394									
	3	27	52	34	42	97	62	59	159	98	75	269	145	99	383	206	119	517	276	139	672	358	163	848	452									
10	1	24	42	22	38	80	42	55	130	71	74	232	108	101	324	153	120	444	216	142	582	277	165	739	348									
	2	26	50	29	40	93	54	57	153	87	76	261	129	103	366	184	123	498	247	145	652	321	168	825	407									
	3	27	55	35	41	105	63	58	170	100	78	284	148	106	397	209	126	540	281	147	705	366	171	893	463									
15	1	24	48	23	38	93	44	54	154	74	72	277	114	100	384	164	125	511	229	153	658	297	184	824	375									
	2	25	55	31	39	105	55	56	174	89	74	299	134	103	419	192	128	558	260	156	718	339	187	900	432									
	3	26	59	35	41	115	64	57	189	102	76	319	153	105	448	215	131	597	292	159	760	382	190	960	486									
20	1	24	52	24	37	102	46	53	172	77	71	313	119	98	437	173	123	584	239	150	752	312	180	943	397									
	2	25	58	31	39	114	56	55	190	91	73	335	138	101	467	199	126	625	270	153	805	354	184	1011	452									
	3	26	63	35	40	123	65	57	204	104	75	353	157	104	493	222	129	661	301	156	851	396	187	1067	505									
30	1	24	54	25	37	111	48	52	192	82	69	357	127	96	504	187	119	680	255	145	883	337	175	1115	432									
	2	25	60	32	38	122	58	54	208	95	72	376	145	99	531	209	122	715	287	149	928	378	179	1171	484									
	3	26	64	36	40	131	66	56	221	107	74	392	163	101	554	233	125	746	317	152	968	418	182	1220	535									
50	1	23	51	25	36	116	51	51	209	89	67	405	143	92	582	213	115	798	294	140	1049	392	168	1334	506									
	2	24	59	32	37	127	61	53	225	102	70	421	161	95	604	235	118	827	326	143	1085	433	172	1379	558									
	3	26	64	36	39	135	69	55	237	115	72	435	180	98	624	260	121	854	357	147	1118	474	176	1421	611									
100	1	23	46	24	35	108	50	49	208	92	65	428	155	88	640	237	109	907	334	134	1222	454	161	1589	596									
	2	24	53	31	37	120	60	51	224	105	67	444	174	92	660	260	113	933	368	138	1253	497	165	1626	651									
	3	25	59	35	38	130	68	53	237	118	69	458	193	94	679	285	116	956	399	141	1282	540	169	1661	705									

Common Vent Capacity

		Minimum Internal Area of Masonry Chimney Flue (in. <sup>2</sup> )																							
		12			19			28			38			50			63			78			113		
		Combined Appliance Input Rating in Thousands of Btu per Hour																							
Vent Height	H	FAN			NAT			FAN			NAT			FAN			NAT			FAN			NAT		
(ft.)	(ft.)	+FAN	+FAN	+NAT	+FAN	+FAN	+NAT	+FAN	+FAN	+NAT	+FAN	+FAN	+NAT	+FAN	+FAN	+NAT	+FAN	+FAN	+NAT	+FAN	+FAN	+NAT	+FAN	+FAN	+NAT
6	6	NA	74	25	NA	119	46	NA	178	71	NA	257	103	NA	351	143	NA	458	188	NA	582	246	1041	853	NA
8	8	NA	80	28	NA	130	53	NA	193	82	NA	279	119	NA	384	163	NA	501	218	724	636	278	1144	937	408
10	10	NA	84	31	NA	138	56	NA	207	90	NA	299	131	NA	409	177	606	538	236	776	686	302	1226	1010	454
15	15	NA	NA	36	NA	152	67	NA	233	106	NA	334	152	523	467	212	682	611	283	874	781	365	1374	1156	546
20	20	NA	NA	41	NA	NA	75	NA	250	122	NA	368	172	565	508	243	742	668	325	955	858	419	1513	1286	648
30	30	NA	NA	NA	NA	NA	NA	NA	270	137	NA	404	198	615	564	278	816	747	381	10062	969	496	1702	1473	749
50	50	NA	NA	NA	NA	NA	NA	NA	NA	NA	NA	NA	NA	NA	620	328	879	831	461	1165	1089	606	1905	1692	922
100	100	NA	NA	NA	NA	NA	NA	NA	NA	NA	NA	NA	NA	NA	NA	348	NA	NA	499	NA	NA	669	2053	1921	1058

Table 5-17 Masonry Chimney

Number of Appliances:	Two or More
Appliance Type:	Category I
Appliance Vent Connection:	Single-Wall Metal Connector

Vent Connector Capacity

Vent Connector Height Rise		Single-Wall Metal Vent Connector Diameter — D (in.)																																															
		3						4						5						6						7						8						9						10					
		Appliance Input Rating Limits in Thousands of Btu per Hour																																															
H	R	FAN		NAT		FAN		NAT		FAN		NAT		FAN		NAT		FAN		NAT		FAN		NAT		FAN		NAT		FAN		NAT		FAN		NAT													
(ft.)	(ft.)	Min	Max	Max	Min	Max	Max	Min	Max	Max	Min	Max	Max	Min	Max	Max	Min	Max	Max	Min	Max	Max	Min	Max	Max	Min	Max	Max	Min	Max	Max	Min	Max	Max															
6	1	NA	NA	21	NA	NA	39	NA	NA	66	179	191	100	231	271	140	292	366	200	362	474	252	499	594	316																								
	2	NA	NA	28	NA	NA	52	NA	NA	84	186	227	123	239	321	172	301	432	231	373	557	299	509	696	376																								
	3	NA	NA	34	NA	NA	61	134	153	97	193	258	142	247	365	202	309	491	269	381	634	348	519	793	437																								
8	1	NA	NA	21	NA	NA	40	NA	NA	68	195	208	103	250	298	146	313	407	207	387	530	263	529	672	331																								
	2	NA	NA	28	NA	NA	52	137	139	85	202	240	125	258	343	177	323	465	238	397	607	309	540	766	391																								
	3	NA	NA	34	NA	NA	62	143	156	98	210	264	145	266	376	205	332	509	274	407	663	356	551	838	450																								
10	1	NA	NA	22	NA	NA	41	130	151	70	202	225	106	267	316	151	333	434	213	410	571	273	558	727	343																								
	2	NA	NA	29	NA	NA	53	136	150	86	210	255	128	276	358	181	343	489	244	420	640	317	569	813	403																								
	3	NA	NA	34	97	102	62	143	166	99	217	277	147	284	389	207	352	530	279	430	694	363	580	880	459																								
15	1	NA	NA	23	NA	NA	43	129	151	73	199	271	112	268	376	161	349	502	225	445	646	291	623	808	366																								
	2	NA	NA	30	92	103	54	135	170	88	207	295	132	277	411	189	359	548	256	456	706	334	634	884	424																								
	3	NA	NA	34	96	112	63	141	185	101	215	315	151	286	439	213	368	586	289	466	755	378	646	945	479																								
20	1	NA	NA	23	87	99	45	128	167	76	197	303	117	265	425	169	345	569	235	439	734	306	614	921	387																								
	2	NA	NA	30	91	111	55	134	185	90	205	325	136	274	455	195	355	610	266	450	787	348	627	986	443																								
	3	NA	NA	35	96	119	64	140	199	103	213	343	154	282	481	219	365	644	298	461	831	391	639	1042	496																								
30	1	NA	NA	24	86	108	47	126	187	80	193	347	124	259	492	183	338	665	250	430	864	330	600	1089	421																								
	2	NA	NA	31	91	119	57	132	203	93	201	366	142	269	518	205	348	699	282	442	908	372	613	1145	473																								
	3	NA	NA	35	95	127	65	138	216	105	209	381	160	277	540	229	358	729	312	452	946	412	626	1193	524																								
50	1	NA	NA	24	85	113	50	124	204	87	188	392	139	252	567	208	328	778	287	417	1022	383	582	1302	492																								
	2	NA	NA	31	89	123	60	130	218	100	196	408	158	262	588	230	339	806	320	429	1058	425	596	1346	545																								
	3	NA	NA	35	94	131	68	136	231	112	205	422	176	271	607	255	349	831	351	440	1090	466	610	1386	597																								
100	1	NA	NA	23	84	104	49	122	200	89	182	410	151	243	617	232	315	875	328	402	1181	444	560	1537	580																								
	2	NA	NA	30	88	115	59	127	215	102	190	425	169	253	636	254	326	899	361	415	1210	488	575	1570	634																								
	3	NA	NA	34	93	124	67	133	228	115	199	438	188	262	654	279	337	921	392	427	1238	529	589	1604	687																								

Common Vent Capacity

Vent Height		Minimum Internal Area of Masonry Chimney Flue (in. <sup>2</sup> )																																															
		12						19						28						38						50						63						78						113					
		Combined Appliance Input Rating in Thousands of Btu per Hour																																															
H	R	FAN		NAT		FAN		NAT		FAN		NAT		FAN		NAT		FAN		NAT		FAN		NAT		FAN		NAT		FAN		NAT		FAN		NAT													
(ft.)	(ft.)	+FAN	+NAT	+FAN	+NAT	+FAN	+NAT	+FAN	+NAT	+FAN	+NAT	+FAN	+NAT	+FAN	+NAT	+FAN	+NAT	+FAN	+NAT	+FAN	+NAT	+FAN	+NAT	+FAN	+NAT	+FAN	+NAT	+FAN	+NAT	+FAN	+NAT	+FAN	+NAT	+FAN	+NAT														
6	1	NA	NA	25	NA	118	45	NA	176	71	NA	255	102	NA	348	142	NA	455	187	NA	579	245	NA	846	NA																								
	2	NA	NA	28	NA	128	52	NA	190	81	NA	276	118	NA	380	162	NA	497	217	NA	633	277	1136	928	405																								
	3	NA	NA	31	NA	136	56	NA	205	89	NA	295	129	NA	405	175	NA	532	234	771	680	300	1216	1000	450																								
15	1	NA	NA	36	NA	NA	66	NA	230	105	NA	335	150	NA	400	210	677	602	280	866	772	360	1359	1139	540																								
	2	NA	NA	NA	NA	NA	74	NA	247	120	NA	362	170	NA	503	240	765	661	321	947	849	415	1495	1264	640																								
	3	NA	NA	NA	NA	NA	NA	NA	NA	135	NA	398	195	NA	558	275	808	739	377	1052	957	490	1682	1447	740																								
50	1	NA	NA	NA	NA	NA	NA	NA	NA	NA	NA	NA	NA	NA	NA	612	325	NA	821	456	1152	1076	600	1879	1672	910																							
	2	NA	NA	NA	NA	NA	NA	NA	NA	NA	NA	NA	NA	NA	NA	NA	NA	NA	NA	NA	NA	NA	NA	NA	NA	NA																							
	3	NA	NA	NA	NA	NA	NA	NA	NA	NA	NA	NA	NA	NA	NA	NA	NA	NA	NA	NA	NA	NA	NA	NA	NA	NA																							

**Table 5-18 Single-Wall Metal Pipe or Type B Asbestos Cement Vent**

<b>Number of Appliances:</b>	<b>Two or More</b>
<b>Appliance Type:</b>	<b>Draft-Hood-Equipped</b>
<b>Appliance Vent Connection:</b>	<b>Direct to Pipe or Vent</b>

**Vent Connector Capacity**

Total Vent Height (ft.)	Connector Rise (ft.)	Vent Connector Diameter – D (in.)					
		3	4	5	6	7	8
Maximum Appliance Input Rating in Thousands of Btu per Hour							
6 - 8	1	21	40	68	102	146	205
	2	28	53	86	124	178	235
	3	34	61	98	147	204	275
15	1	23	44	77	117	179	240
	2	30	56	92	134	194	265
	3	35	64	102	155	216	298
30 and up	1	25	49	84	129	190	270
	2	31	58	97	145	211	295
	3	36	68	107	164	232	321

**Common Vent Capacity**

Total Vent Height	Common Vent Diameter – D (in.)						
	4	5	6	7	8	10	12
6	48	78	111	155	205	320	NA
8	55	89	128	175	234	365	505
10	59	95	136	190	250	395	560
15	71	115	168	228	305	480	690
20	80	129	186	260	340	550	790
30	NA	147	215	300	400	650	940
50	NA	NA	NA	360	490	810	1190

Table 5-19 Exterior Masonry Chimney

Special Use:		Minimum Allowable Input Rating of Space-Heating Appliance in Thousands of Btu per Hour							
Number of Appliances:		Single							
Appliance Type:		NAT							
Appliance Vent Connection:		Type B Double-Wall Connector							
Vent Height (ft.)	Internal Area of Chimney (Square Inches)								
	12	19	28	38	50	63	78	113	
37°F or greater		Local 99% winter design temperature: 37°F or greater							
6	0	0	0	0	0	0	0	0	
8	0	0	0	0	0	0	0	0	
10	0	0	0	0	0	0	0	0	
15	NA	0	0	0	0	0	0	0	
20	NA	NA	123	190	249	184	0	0	
30	NA	NA	NA	NA	NA	393	334	0	
50	NA	NA	NA	NA	NA	NA	NA	579	
27°F to 36°F		Local 99% Winter Design Temperature: 27°F to 36°F							
6	0	0	68	116	156	180	212	266	
8	0	0	82	127	167	187	214	263	
10	0	51	97	141	183	201	225	265	
15	NA	NA	NA	NA	233	253	274	305	
20	NA	NA	NA	NA	NA	307	330	362	
30	NA	NA	NA	NA	NA	419	445	485	
50	NA	NA	NA	NA	NA	NA	NA	763	
17°F to 26°F		Local 99% Winter Design Temperature: 17°F to 26°F							
6	NA	NA	NA	NA	NA	215	259	349	
8	NA	NA	NA	NA	197	226	264	352	
10	NA	NA	NA	NA	214	245	278	358	
15	NA	NA	NA	NA	NA	296	331	398	
20	NA	NA	NA	NA	NA	352	387	457	
30	NA	NA	NA	NA	NA	NA	507	581	
50	NA	NA	NA	NA	NA	NA	NA	NA	
		Local 99% Winter Design Temperature: 5°F to 16°F							
6	NA	NA	NA	NA	NA	NA	NA	416	
8	NA	NA	NA	NA	NA	NA	312	423	
10	NA	NA	NA	NA	NA	289	331	430	
15	NA	NA	NA	NA	NA	NA	393	485	
20	NA	NA	NA	NA	NA	NA	450	547	
30	NA	NA	NA	NA	NA	NA	NA	682	
50	NA	NA	NA	NA	NA	NA	NA	972	
		Local 99% Winter Design Temperature: -10°F to 4°F							
6	NA	NA	NA	NA	NA	NA	NA	484	
8	NA	NA	NA	NA	NA	NA	NA	494	
10	NA	NA	NA	NA	NA	NA	NA	513	
15	NA	NA	NA	NA	NA	NA	NA	586	
20	NA	NA	NA	NA	NA	NA	NA	650	
30	NA	NA	NA	NA	NA	NA	NA	805	
50	NA	NA	NA	NA	NA	NA	NA	1003	
-11°F or Lower		Local 99% Winter Design Temperature: -11°F or Lower Not recommended for any vent configurations							

Table 5-20(a) Exterior Masonry Chimney

Special Use:		Combined Appliance Maximum Input Rating in Thousands of Btu per Hour							
Number of Applications:		Two or More							
Appliance Type:		NAT + NAT							
Appliance Vent Connection:		Type B Double-Wall Connector							
Vent Height (ft)	Internal Area of Chimney (Square Inches)								
	12	19	28	38	50	63	78	113	
6	25	46	71	103	143	188	246	NA	
8	28	53	82	119	163	218	278	408	
10	31	56	90	131	177	236	302	454	
15	NA	67	106	152	212	283	365	546	
20	NA	NA	NA	NA	NA	325	419	648	
30	NA	NA	NA	NA	NA	NA	496	749	
50	NA	NA	NA	NA	NA	NA	NA	922	
100	NA	NA	NA	NA	NA	NA	NA	NA	

Table 5-20(b) Exterior Masonry Chimney

Special Use:		Combined Appliance Maximum Input Rating in Thousands of Btu per Hour							
Number of Applications:		Two or More							
Appliance Type:		NAT + NAT							
Appliance Vent Connection:		Type B Double-Wall Connector							
Vent Height (ft)	Internal Area of Chimney (Square Inches)								
	12	19	28	38	50	63	78	113	
37°F or Greater	Local 99% Winter Design Temperature: 37°F or Greater								
6	0	0	0	0	0	0	0	NA	
8	0	0	0	0	0	0	0	0	
10	0	0	0	0	0	0	0	0	
15	NA	0	0	0	0	0	0	0	
20	NA	NA	NA	NA	NA	184	0	0	
30	NA	NA	NA	NA	NA	393	334	0	
50	NA	NA	NA	NA	NA	NA	NA	579	
100	NA	NA	NA	NA	NA	NA	NA	NA	
27°F to 36°F	Local 99% Winter Design Temperature: 27°F to 36°F								
6	0	0	68	NA	NA	180	212	NA	
8	0	0	82	NA	NA	187	214	263	
10	0	51	NA	NA	NA	201	225	265	
15	NA	NA	NA	NA	NA	253	274	305	
20	NA	NA	NA	NA	NA	307	330	362	
30	NA	NA	NA	NA	NA	NA	445	485	
50	NA	NA	NA	NA	NA	NA	NA	763	
100	NA	NA	NA	NA	NA	NA	NA	NA	

Table 5-20(b) Continued

17°F to 26°F		Local 99% Winter Design Temperature 17 to 26°F							
6	NA	NA	NA	NA	NA	NA	NA	NA	NA
8	NA	NA	NA	NA	NA	NA	NA	264	352
10	NA	NA	NA	NA	NA	NA	NA	278	358
15	NA	NA	NA	NA	NA	NA	NA	331	398
20	NA	NA	NA	NA	NA	NA	NA	387	457
30	NA	NA	NA	NA	NA	NA	NA	NA	581
50	NA	NA	NA	NA	NA	NA	NA	NA	862
100	NA	NA	NA	NA	NA	NA	NA	NA	NA

		Local 99% Winter Design Temperature 5 to 16°F							
6	NA	NA	NA	NA	NA	NA	NA	NA	NA
8	NA	NA	NA	NA	NA	NA	NA	NA	NA
10	NA	NA	NA	NA	NA	NA	NA	NA	430
15	NA	NA	NA	NA	NA	NA	NA	NA	485
20	NA	NA	NA	NA	NA	NA	NA	NA	547
30	NA	NA	NA	NA	NA	NA	NA	NA	682
50	NA	NA	NA	NA	NA	NA	NA	NA	NA
100	NA	NA	NA	NA	NA	NA	NA	NA	NA

4°F or Lower		Local 99% Winter Design Temperature 4°F or Lower Not recommended for any vent configuration							

Table 5-21(a) Exterior Masonry Chimney

Special Use:		Combined Appliance Maximum Input Rating in Thousand of Btu per Hour							
Number of Applications:		Two or More							
Appliance Type:		FAN + NAT							
Vent Height H (ft.)	Internal Area of Chimney (Square Inches)								
	12	19	28	38	50	63	78	113	
6	74	119	178	257	351	458	582	853	
8	80	130	193	279	384	501	636	937	
10	84	138	207	299	409	538	686	1010	
15	NA	152	233	334	467	611	781	1156	
20	NA	NA	250	368	508	668	858	1286	
30	NA	NA	NA	404	564	747	969	1473	
50	NA	NA	NA	NA	NA	831	1089	1692	
100	NA	NA	NA	NA	NA	NA	NA	1921	

WATER HEATERS

Table 5-21(b) Exterior Masonry Chimney

Special Use:		Minimum Allowable Input Rating of Space-Heating Appliance in Thousands of Btu per Hour							
Number of Applications:		Two or More							
Appliance Type:		NAT + NAT							
Appliance Vent Connection:		Type B Double-Wall Connector							
Vent Height (ft.)	Internal Area of Chimney (Square Inches)								
	12	19	28	38	50	63	78	113	
37°F or greater		Local 99% Winter Design Temperature: 37°F or Greater							
6	0	0	0	0	0	0	0	0	
8	0	0	0	0	0	0	0	0	
10	0	0	0	0	0	0	0	0	
15	NA	0	0	0	0	0	0	0	
20	NA	NA	123	190	249	184	0	0	
30	NA	NA	NA	334	398	393	334	0	
50	NA	NA	NA	NA	NA	714	707	579	
100	NA	NA	NA	NA	NA	NA	NA	1600	
27°F to 36°F		Local 99% Winter Design Temperature: 27°F to 36°F							
6	0	0	68	116	156	180	212	266	
8	0	0	82	127	167	187	214	263	
10	0	51	97	141	183	210	225	265	
15	NA	111	142	183	233	253	274	305	
20	NA	NA	187	230	284	307	330	362	
30	NA	NA	NA	330	319	419	445	485	
50	NA	NA	NA	NA	NA	672	705	763	
100	NA	NA	NA	NA	NA	NA	NA	1554	
17°F TO 26°F		Local 99% Winter Design Temperature: 17°F to 26°F							
6	0	55	99	141	182	215	259	349	
8	52	74	111	154	197	226	264	352	
10	NA	90	125	169	214	245	278	358	
15	NA	NA	167	212	263	296	331	398	
20	NA	NA	212	258	316	352	387	457	
30	NA	NA	NA	362	429	470	507	581	
50	NA	NA	NA	NA	NA	723	766	862	
100	NA	NA	NA	NA	NA	NA	NA	1669	
5°F TO 16°F		Local 99% Winter Design Temperature: 5°F to 16°F							
6	NA	78	121	166	214	252	301	416	
8	NA	94	135	182	230	269	312	423	
10	NA	111	149	198	250	289	331	430	
15	NA	NA	193	247	305	346	393	485	
20	NA	NA	NA	293	360	408	450	682	
30	NA	NA	NA	377	450	531	580	682	
50	NA	NA	NA	NA	NA	797	853	972	
100	NA	NA	NA	NA	NA	NA	NA	1833	
-10°F to 4°F		Local 99% Winter Design Temperature -10°F to 4°F							
6	NA	NA	145	196	249	296	349	484	
8	NA	NA	159	213	269	320	371	494	
10	NA	NA	175	231	292	339	397	513	
15	NA	NA	NA	283	351	404	457	586	
20	NA	NA	NA	333	408	468	528	650	
30	NA	NA	NA	NA	NA	603	667	805	
50	NA	NA	NA	NA	NA	NA	955	1003	
100	NA	NA	NA	NA	NA	NA	NA	NA	
-11°F or Lower		Local 99% Winter Design Temperature: -11°F or Lower Not recommended for any vent configurations							



PART II

This is originally from NFPA 54, which contains additional references.

Sizing of Venting Systems Serving Appliances Equipped with Draft Hoods, Category I Appliances, and Appliances Listed for Use with Type B Vents

G.1 Examples Using Single Appliance Venting Tables. See Figure G.1(a) through Figure G.1(n).

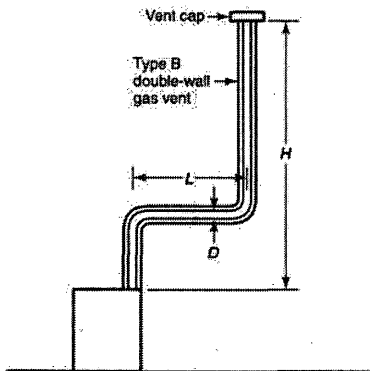

Table 5-9 is used when sizing Type B double-wall gas vent connected directly to the appliance.

Note: The appliance can be either Category I draft hood-equipped or fan-assisted type.

FIGURE G.1(a) Type B Double-Wall Vent System Serving a Single Appliance with a Type B Double-Wall Vent.

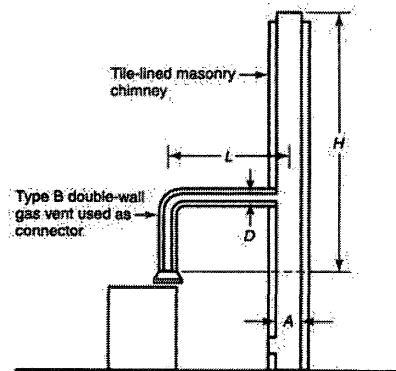

Table 5-11 is used when sizing a Type B double-wall gas vent connector attached to a tile-lined masonry chimney.

Notes:

1. A is the equivalent cross-sectional area of the tile liner.
2. The appliance can be either Category I draft hood-equipped or fan-assisted type.

FIGURE G.1(c) Vent System Serving a Single Appliance with a Masonry Chimney and a Type B Double-Wall Vent Connector.

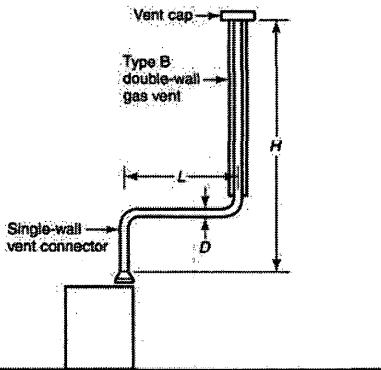

Table 5-10 is used when sizing a single-wall metal vent connector attached to a Type B double-wall gas vent.

Note: The appliance can be either Category I draft hood-equipped or fan-assisted type.

FIGURE G.1(b) Type B Double-Wall Vent System Serving a Single Appliance with a Single-Wall Metal Vent Connector.

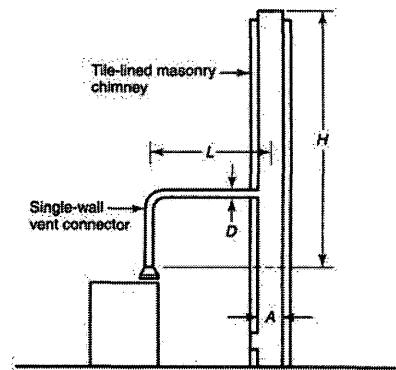
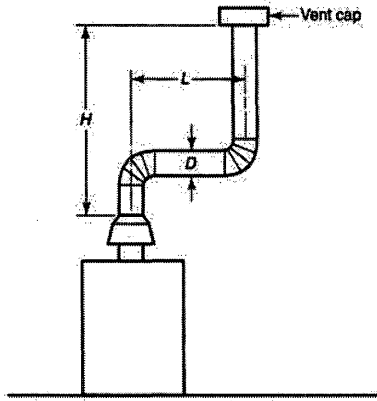

Table 5-12 is used when sizing a single-wall vent connector attached to a tile-lined masonry chimney.

Notes:

1. A is the equivalent cross-sectional area of the tile liner.
2. The appliance can be either Category I draft hood-equipped or fan-assisted type.

FIGURE G.1(d) Vent System Serving a Single Appliance Using a Masonry Chimney and a Single-Wall Metal Vent Connector.



Asbestos cement Type B or single-wall metal vent serving a single draft hood-equipped appliance. (See Table 5-13)

**FIGURE G.1(e) Asbestos Cement Type B or Single-Wall Metal Vent System Serving a Single Draft Hood-Equipped Appliance.**

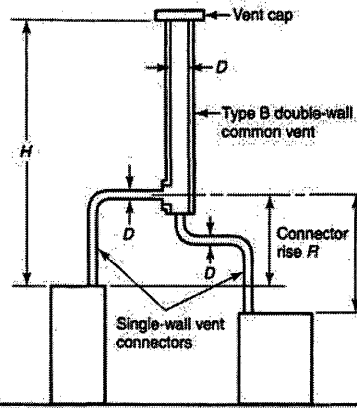

Table 5-15 is used when sizing single-wall vent connectors attached to a Type B double-wall common vent.

Note: Each appliance can be either Category I draft hood-equipped or fan-assisted type.

**FIGURE G.1(g) Vent System Serving Two or More Appliances with Type B Double-Wall Vent and Single-Wall Metal Vent Connectors.**

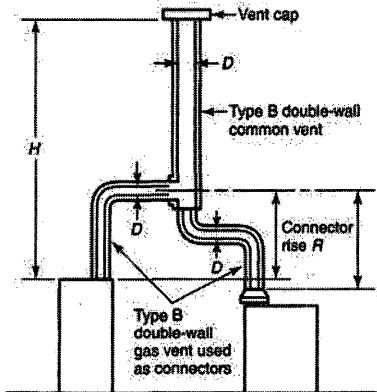

Table 5-10 is used when sizing Type B double-wall gas vent connectors attached to a Type B double-wall common vent.

Note: Each appliance can be either Category I draft hood-equipped or fan-assisted type.

**FIGURE G.1(f) Vent System Serving Two or More Appliances with Type B Double-Wall Vent and Type B Double-Wall Vent Connectors.**

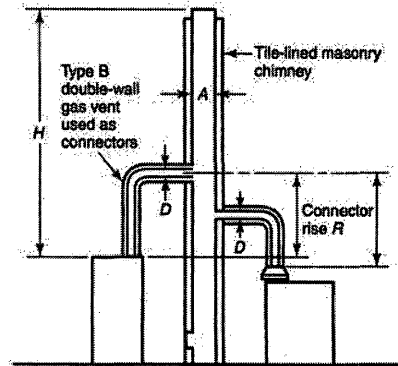

Table 5-12 is used when sizing Type B double-wall vent connectors attached to a tile-lined masonry chimney.

Notes:

1. A is the equivalent cross-sectional area of the tile liner.
2. Each appliance can be either Category I draft hood-equipped or fan-assisted type.

**FIGURE G.1(h) Masonry Chimney Serving Two or More Appliances with Type B Double-Wall Vent Connectors.**

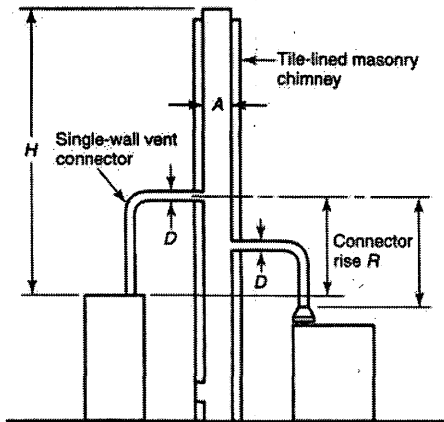
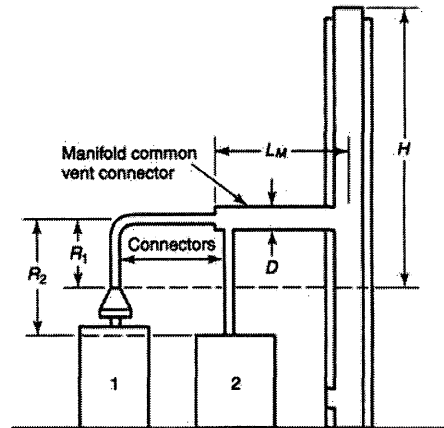

Table 5-17 is used when sizing single-wall metal vent connectors attached to a tile-lined masonry chimney.

Notes:

1. A is the equivalent cross-sectional area of the tile liner.
2. Each appliance can be either Category I draft hood-equipped or fan-assisted type.

**FIGURE G.1(i) Masonry Chimney Serving Two or More Appliances with Single-Wall Metal Vent Connectors.**



Example: Manifolded common vent connector  $L_M$  can be no greater than 18 times the common vent connector manifold inside diameter; that is, a 4 in. (100 mm) inside diameter common vent connector manifold should not exceed 72 in. (1800 mm) in length.

Note: This is an illustration of a typical manifolded vent connector. Different appliance, vent connector, or common vent types are possible.

**FIGURE G.1(k) Use of Manifolded Common Vent Connector.**

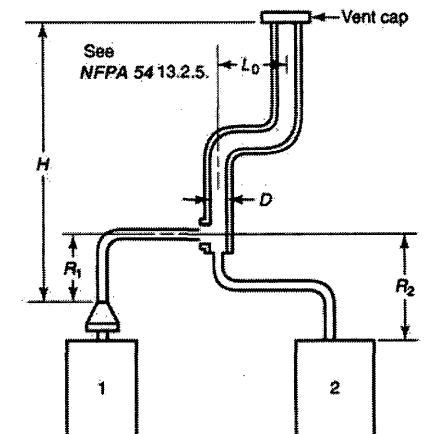

Asbestos cement Type B or single-wall metal pipe vent serving two or more draft hood-equipped appliances. (See Table 5-18)

**FIGURE G.1(j) Asbestos Cement Type B or Single-Wall Metal Vent System Serving Two or More Draft Hood-Equipped Appliances.**

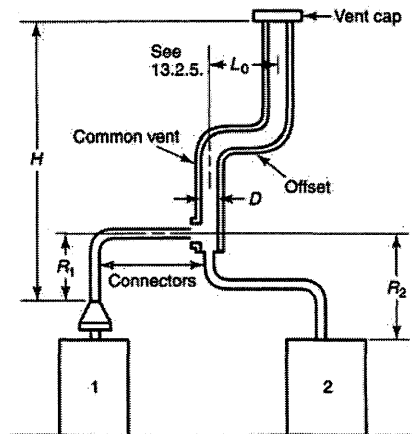

Example: Offset common vent

Note: This is an illustration of a typical offset vent. Different appliance, vent connector, or vent types are possible.

**FIGURE G.1(l) Use of Offset Common Vent.**

**G.1.1 Example 1: Single Draft-Hood-Equipped Appliance.** An installer has a 120,000-Btu/h input appliance with a 5 in. diameter draft hood outlet that needs to be vented into a 10 ft high Type B vent system. What size vent should be used assuming (1) a 5 ft lateral single-wall metal vent connector is used with two 90 degree elbows or (2) a 5 ft lateral single-wall metal vent connector is used with three 90 degree elbows in the vent system? See Figure G.1.1.

*Solution*

Table 5-10 should be used to solve this problem because single-wall metal vent connectors are being used with a Type B vent, as follows:

- (1) Read down the first column in Table 5-10 until the row associated with a 10 ft height and 5 ft lateral is found. Read across this row until a vent capacity greater than 120,000 Btu/h is located in the shaded columns labeled NAT Max for draft-hood-equipped appliances. In this case, a 5 in. diameter vent has a capacity of 122,000 Btu/h and can be used for this application.
- (2) If three 90 degree elbows are used in the vent system, the maximum vent capacity listed in the tables must be reduced by 10 percent (see NFPA 54:13.1.3). This implies that the 5 in. diameter vent has an adjusted capacity of only 110,000

Btu/h. In this case, the vent system must be increased to 6 in. in diameter. See the following calculations:

$$122,000 \times 0.90 = 110,000 \text{ for 5 in. vent}$$

From Table 5-10, select 6 in. vent.

$$186,000 \times 0.90 = 167,000$$

This figure is greater than the required 120,000. Therefore, use a 6 in. vent and connector where three elbows are used.

**G.1.2. Example 2: Single Fan-Assisted Appliance.** An installer has an 80,000 Btu/h input fan-assisted appliance that must be installed using 10 ft of lateral connector attached to a 30 ft high Type B vent. Two 90 degree elbows are needed for the installation. Can a single-wall metal vent connector be used for this application? See Figure G.1.2.

*Solution*

Table 5-10 refers to the use of single-wall metal vent connectors with Type B vent. In the first column find the row associated with a 30 ft height and a 10 ft lateral. Read across this row, looking at the FAN

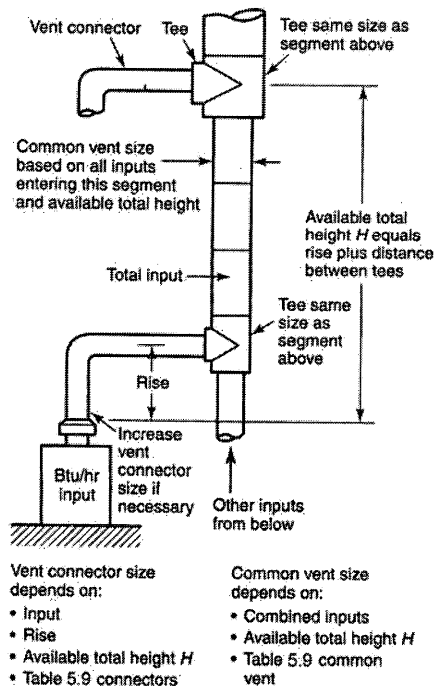

**FIGURE G.1(m) Multistory Gas Vent Design Procedure for Each Segment of System.**

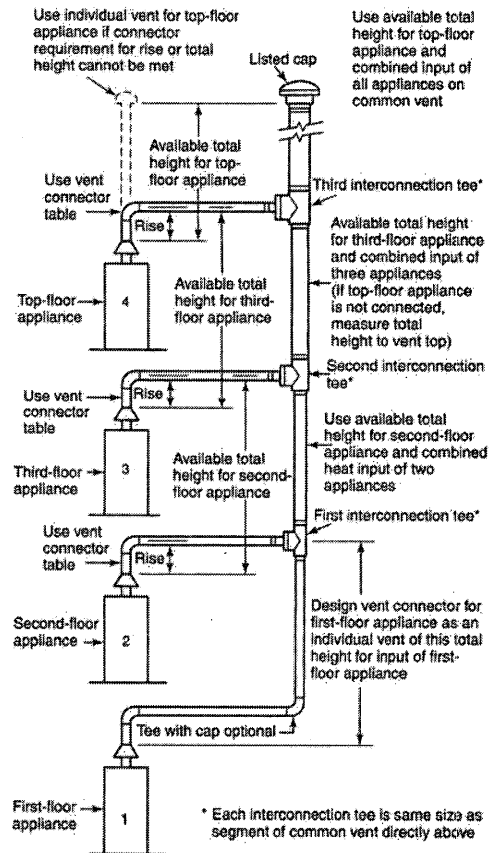

**FIGURE G.1(n) Principles of Design of Multistory Vents Using Vent Connector and Common Vent Design Tables.**

Min and FAN Max columns, to find that a 3 in. diameter single-wall metal vent connector is not recommended. Moving to the next larger size single-wall connector (4 in.), we find that a 4 in. diameter single-wall metal connector has a recommended maximum vent capacity of 144,000 Btu/h. The 80,000 Btu/h fan-assisted appliance is outside this range, so the conclusion is that a single-wall metal connector could be used to vent the appliance. Table 5-10 shows the acceptable range of vent capacities for a 4 in. vent with 5 ft of lateral to be between 72,000 Btu/h and 157,000 Btu/h.

If the appliance cannot be moved closer to the vertical vent, then a Type B vent could be used as the connector material. In this case, Table 5-9 shows that, for a 30 ft high vent with 10 ft of lateral, the acceptable range of vent capacities for a 4 in. diameter vent attached to a fan-assisted appliance is between 37,000 Btu/h and 150,000 Btu/h.

**G.1.3. Example 3: Interpolating Between Table Values.** An installer has an 80,000 Btu/h input appliance with a 4 in. diameter draft hood outlet that needs to be vented into a 12 ft high Type B. Can this appliance be vented using a 4 in. diameter vent?

*Solution*

Table 5-9 is used in the case of an all Type B Vent system. However, since there is no entry in Table 5-9 for a height of 12 ft, interpolation must be used. Read down the 4 in. diameter NAT Max column to the row associated with a 10 ft height and 5 ft lateral to find the capacity value of 77,000 Btu/h. Read further down to the 15 ft height, 5 ft lateral row to find the capacity value of 87,000 Btu/h. The difference between the 15 ft height capacity value and the 10 ft height capacity value is 10,000 Btu/h. The capacity for a vent system with a 12 ft height is equal to the capacity for a 10 ft height plus  $2/5$  of the difference between the 10 ft and 15 ft height values, or  $77,000 + 2/5 \times 10,000 = 81,000$  Btu/h. Therefore, a 4 in. diameter vent can be used in the installation.

**G.2 Examples Using Common Venting Tables.**

**G.2.1 Example 4: Common Venting Two Draft-Hood-Equipped Appliances.** A 35,000-Btu/h water heater is to be common vented with a 150,000 Btu/h furnace, using a common vent with a total height of 30 ft. The connector rise is 2 ft for the water heater with a horizontal length of 4 ft. The connector rise for the furnace is 3 ft with a horizontal length of 8 ft. Assume single-wall metal connectors will be used with Type B vent. What size connectors and combined vent should be used in this installation?

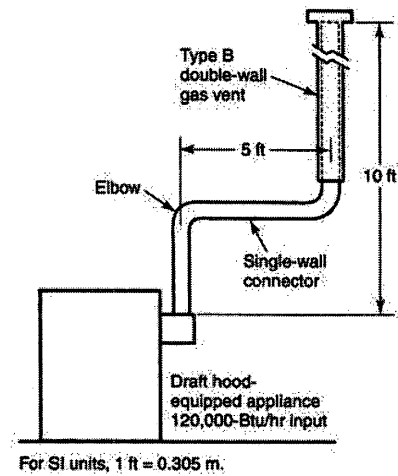

**FIGURE G.1.1 Single Draft Hood-Equipped Appliance — Example 1.**

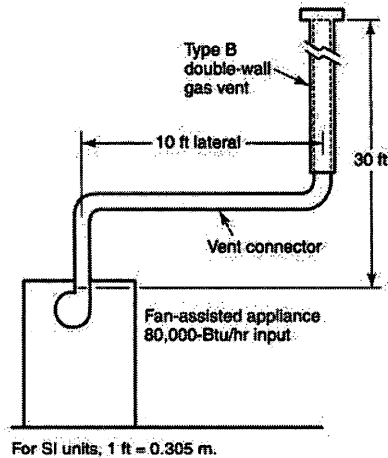

**FIGURE G.1.2 Single Fan-Assisted Appliance — Example 2.**

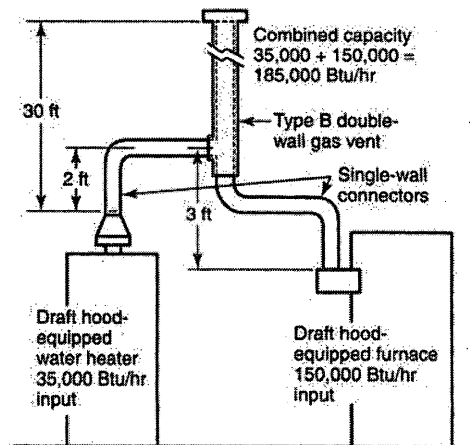

**FIGURE G.2.1 Common Venting Two Draft Hood-Equipped Appliances — Example 4.**

See Figure G.2.1.

**Solution**

Table 5-15 should be used to size single-wall metal vent connectors attached to Type B vertical vents. In the Vent Connector Capacity portion of Table 5-15, find the row associated with a 30 ft vent height. For a 2 ft rise on the vent connector for the water heater, read the shaded columns for draft-hood-equipped appliances to find that a 3 in. diameter vent connector has a capacity of 37,000 Btu/h. Therefore, a 3 in. single-wall metal vent connector can be used with the water heater. For a draft-hood-equipped furnace with a 3 ft rise, read across the appropriate row to find that a 5 in. diameter vent connector has a maximum capacity of 120,000 Btu/h (which is too small for the furnace), and a 6 in. diameter vent connector has a maximum vent capacity of 172,000 Btu/h. Therefore, a 6 in. diameter vent connector should be used with the 150,000 Btu per h furnace. Since both vent connector horizontal lengths are less than the maximum lengths listed in Table 5-8, the table values can be used without adjustments.

In the Common Vent Capacity portion of Table 5-15, find the row associated with a 30 ft vent height and read over to the NAT + NAT portion of the 6 in. diameter column to find a maximum combined capacity of 257,000 Btu/h. Since the two appliances total only 185,000 Btu/h, a 6 in. common vent can be used.

**G.2.2 Example 5 (a): Common Venting a Draft-Hood-Equipped Water Heater with a Fan-Assisted Furnace into a Type B Vent.** In this case, a 35,000-Btu/h input draft-hood-equipped water heater with a 4 in. diameter draft hood outlet, 2 ft of connector rise, and 4 ft of horizontal length is to be common vented with a 100,000 Btu/h fan-assisted furnace with a 4 in. diameter flue collar, 3 ft of connector rise, and 6 ft of horizontal length. The common vent consists of a 30 ft height of Type B vent. What are the recommended vent diameters for each connector and the common vent? The installer would like to use a single-wall metal vent connector. See Figure G.2.2.

**Solution (See Table 5-15)**

**Water Heater Vent Connector Diameter.** Since the water heater vent connector horizontal length of 4 ft is less than the maximum value listed in Table 5-15, the venting table values can be used without adjustment. Using the Vent Connector Capacity portion of Table 5-15, read down the Total Vent Height (*H*) column to 30 ft and read across the 2 ft Connector Rise (*R*) row to the first Btu/h rating in the NAT Max column that is equal to or greater than

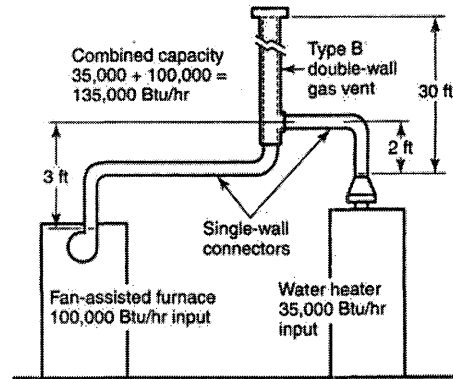

For SI units, 1000 Btu/hr = 0.293 kW, 1 ft = 0.305 m.

**FIGURE G.2.2 Common Venting a Draft Hood-Equipped Water Heater with a Fan-Assisted Furnace into a Type B Double-Wall Common Vent — Example 5(a).**

**TABLE G.2.3 Masonry Chimney Liner Dimensions with Circular Equivalents**

Nominal Liner Size (in.)	Inside Dimensions of Liner (in.)	Inside Diameter or Equivalent Diameter (in.)	Equivalent Area (in. <sup>2</sup> )
4 x 8	2-1/2 x 6-1/2	4.0	12.2
		5.0	19.6
		6.0	28.3
		7.0	38.3
8 x 8	6-3/4 x 6-3/4	7.4	42.7
		8.0	50.3
8 x 12	6-1/2 x 10-1/2	9.0	63.6
		10.0	78.5
12 x 12	9-3/4 x 9-3/4	10.4	83.3
		11.0	95.0
12 x 16	9-1/2 x 13-1/2	11.8	107.5
		12.0	113.0
16 x 16	13-1/4 x 13-1/4	14.0	153.9
		14.5	162.9
16 x 20	13 x 17	15.0	176.7
		16.2	206.1
20 x 20	16-1/2 x 16-3/4	18.0	254.4
		18.2	260.2
20 x 24	16-1/2 x 20-1/2	20.0	314.1
		20.1	314.2
24 x 24	20-1/4 x 20-1/4	22.0	308.1
		22.1	308.1
24 x 28	20-1/4 x 24-1/4	24.0	452.3
		24.1	456.2
28 x 28	24-1/4 x 24-1/4	26.4	543.3
		27.0	572.5
30 x 30	25-1/2 x 25-1/2	27.9	607.0
		30.9	749.9
30 x 36	25-1/2 x 31-1/2	33.0	855.3
		34.4	929.4
36 x 36	31-1/2 x 31-1/2	36.0	1017.9

For SI units, 1 in. = 25.4 mm, 1 in.<sup>2</sup> = 645 mm<sup>2</sup>.

Note: When liner sizes differ dimensionally from those shown in this table, equivalent diameters can be determined from published tables for square and rectangular ducts of equivalent carrying capacity or by other engineering methods.

the water heater input rating. The table shows that a 3 in. vent connector has a maximum input rating of 37,000 Btu/h. Although this rating is greater than the water heater input rating, a 3 in. vent connector is prohibited by Section 511.2.18. A 4 in. vent connector has a maximum input rating of 67,000 Btu/h and is equal to the draft hood outlet diameter. A 4 in. vent connector is selected. Since the water heater is equipped with a draft hood, there are no minimum input rating restrictions.

*Furnace Vent Connector Diameter.* Using the Vent Connector Capacity portion of Table 5-15, read down the Total Vent Height (*H*) column to 30 ft and across the 3 ft Connector Rise (*R*) row. Since the furnace has a fan-assisted combustion system, find the first FAN Max column with a Btu/h rating greater than the furnace input rating. The 4 in. vent connector has a maximum input rating of 119,000 Btu/h and a minimum input rating of 85,000 Btu/h.

The 100,000-Btu/h furnace in this example falls within this range, so a 4 in. connector is adequate. Since the furnace vent connector horizontal length of 6 ft is less than the maximum value listed in Table 5-8, the venting table values can be used without adjustment. If the furnace had an input rating of 80,000 Btu/h, then a Type B vent connector (see Table 5-14)

*Common Vent Diameter.* The total input to the common vent is 135,000 Btu/h. Using the Common Vent Capacity portion of Table 5-15, read down the Vent Height (*H*) column to 30 ft and across this row to find the smallest vent diameter in the FAN + NAT column that has a Btu/h rating equal to or greater than 135,000 Btu/h. The 4 in. common vent has a capacity of 132,000 Btu/h and the 5 in. common vent has a capacity of 202,000 Btu/h. Therefore, the 5 in. common vent should be used in this example.

*Summary.* In this example, the installer can use a 4 in. diameter, single-wall metal vent connector for the water heater and a 4 in. diameter, single-wall metal vent connector for the furnace. The common vent should be a 5 in. diameter Type B vent.

**G.2.3 Example 5 (b):** Common Venting into an Interior Masonry Chimney. In this case, the water heater and fan-assisted furnace of Example 5 (a) are to be common-vented into a clay-tile-lined masonry chimney with a 30 ft height. The chimney is not exposed to the outdoors below the roof line. The internal dimensions of the clay tile liner are nominally 8 in. x 12 in. Assuming the same vent connector heights, laterals, and materials found in example 5 (a), what are the recommended vent connector diameters, and is this an acceptable installation?

*Solution*

Table 5-17 is used to size common venting

installations involving single-wall connectors into masonry chimneys.

*Water Heater Vent Connector Diameter.* Using Table 5-17, Vent Connector Capacity, read down the Vent Height (*H*) column to 30 ft, and read across the 2 ft Connector Rise (*R*) row to the first Btu/h rating in the NAT Max column that is equal to or greater than the water heater input rating. The table shows that a 3 in. vent connector has a maximum input of only 31,000 Btu/h, while a 4 in. vent connector has a maximum input of 57,000 Btu/h. A 4 in. vent connector must therefore be used.

*Furnace Vent Connector Diameter.* Using the Vent Connector Capacity portion of Table 5-17, read down the total Vent Height (*H*) column to 30 ft and across the 3 ft Connector Rise (*R*) row. Because the furnace has a fan-assisted combustion system, find the first FAN Max column with a Btu/h rating greater than the furnace input rating. The 4 in. vent connector has a maximum input rating of 127,000 Btu/h and a minimum input rating of 95,000 Btu/h. The 100,000 Btu/h furnace in this example falls within this range, so a 4 in. connector is adequate.

*Masonry Chimney.* From Table G.2.3, the equivalent area for a nominal liner size of 8 in. x 12 in. is 63.6 in<sup>2</sup>. Using Table 5-17, Common Vent Capacity, read down the FAN + NAT column under the Minimum Internal Area of Chimney value of 63 to the row for 30 ft height to find a capacity value of 739,000 Btu/h. The combined input rating of the furnace and water heater, 135,000 Btu/h, is less than the table value so this is an acceptable installation.

Section 511.2.4 requires the common vent area to be no greater than seven times the smallest listed appliance categorized vent area, flue collar area, or draft hood outlet area. Both appliances in this installation have 4 in. diameter outlets. From Table G.2.3, the equivalent area for an inside diameter of 4 in. is 12.2 in<sup>2</sup>. Seven times 12.2 equals 85.4, which is greater than 63.6, so this configuration is acceptable.

**G.2.4 Example 5 (c):** Common Venting into an Exterior Masonry Chimney. In this case, the water heater and fan-assisted furnace of Examples 5 (a) and 5 (b) are to be common-vented into an exterior masonry chimney. The chimney height, clay-tile-liner dimensions, and vent connector heights and laterals are the same as in Example 5 (b). This system is being installed in Charlotte, North Carolina. Does this exterior masonry chimney need to be relined? If so, what corrugated metallic liner size is recommended? What vent connector diameters are recommended? See Table G.2.3 and Figure 5-14.

*Solution*

According to 13.2.18 Type B vent connectors are

## WATER HEATERS

required to be used with exterior masonry chimneys. Use Table 5-21(a) and Table 5-21(b) to size FAN+NAT common venting installations involving Type-B double-wall connectors into exterior masonry chimneys.

The local 99 percent winter design temperature needed to use Table 5-21(a) and Table 5-21(b) can be found in the ASHRAE Handbook – Fundamentals. For Charlotte, North Carolina, this design temperature is 19°F.

**Chimney Liner Requirement.** As in Example 5 (b), use the 63 in.<sup>2</sup> column of Table 5-21(a) to the 30 ft height row to find that the combined appliance maximum input is 747,000 Btu/h. The combined input rating of the appliance in this installation, 135,000 Btu/h, is less than the maximum value, so this criterion is satisfied. Table 5-21(b), at a 19°F design temperature, and at the same vent height and internal area used earlier, shows that the minimum allowable input rating of a space-heating appliance is 470,000 Btu/h. The furnace input rating of 100,000 Btu/h is less than this minimum value. So this criterion is not satisfied, and an alternative venting design needs to be used, such as a Type B vent shown in Example 5 (a) or a listed chimney liner system shown in the rest of the example.

According to Section 511.1.6, Table 5-9 or Table 5-10 are used for sizing corrugated metallic liners in masonry chimneys, with the maximum common vent capacities reduced by 20 percent. This example will be continued assuming Type B vent connectors.

**Water Heater Vent Connector Diameter.** Use Table 5-14 or Table 5-15 for sizing corrugated metallic liners in masonry chimneys, with the maximum common vent capacities reduced by 20 percent. This example will be continued assuming Type B vent connectors.

**Water Heater Vent Connector Diameter.** Using Table 5-14 Connector Capacity, read down the total Vent Height (*H*) column to 30 ft, and read across the 2 ft Connector Rise (*R*) row to the first Btu/hour rating in the NAT Max column that is equal to or greater than the water heater input rating. The table shows that a 3 in. vent connector has a maximum capacity of 39,000 Btu/h. Although this rating is greater than the water heater input rating, a 3 in. vent connector is prohibited by 511.1.6. A 4 in. vent connector has a maximum input rating of 70,000 Btu/h and is equal to the draft hood outlet diameter. A 4 in. vent connector is selected.

**Furnace Vent Connector Diameter.** Using Table 5-14, Vent Connector Capacity, read down the total Vent Height (*H*) column to 30 ft, and read across the 3 ft Connector Rise (*R*) row to the first Btu/h rating in the FAN MAX column that is equal to or greater than the furnace input rating. The 100,000 Btu/h

furnace in this example falls within this range, so a 4 in. connector is adequate.

**Chimney Liner Diameter.** The total input to the common vent is 135,000 Btu/h. Using the Common Vent Capacity portion of Table 5-14, read down the total Vent Height (*H*) column to 30 ft and across this row to find the smallest vent diameter in the FAN + NAT column that has a Btu/h rating greater than 135,000 Btu/h. The 4 in. common vent has a capacity of 138,000 Btu/h. Reducing the maximum capacity by 20 percent (see 13.2.19) results in a maximum capacity for a 4 in. corrugated liner of 110,000 Btu/h, less than the total input of 135,000 Btu/h. So a larger liner is needed. The 5 in. common vent capacity listed in Table 5-14 is 210,000 Btu/h, and after reducing by 20 percent is 168,000 Btu/h. Therefore, a 5 in. corrugated metal liner should be used in this example.

**Single Wall Connectors.** Once it has been established that relining the chimney is necessary, Type B double-wall vent connectors are not specifically required. This example could be redone using Table 5-15 for single-wall vent connectors. For this case, the vent connector and liner diameters would be the same as found for Type B double-wall connectors.

**The following is originally from NFPA 54 which contains additional reference.**

### Example of Combination of Indoor and Outdoor Combustion and Ventilation Opening Design

**J.1 Example of Combination Indoor and Outdoor Combustion Air Opening.** Determine the required combination of indoor and outdoor combustion air opening sizes for the following equipment installation example.

**Example Installation:** A fan-assisted furnace and a draft-hood-equipped water heater with the following inputs are located in a 15 ft x 30 ft basement with an 8 ft ceiling. No additional indoor spaces can be used to help meet the equipment combustion air needs.

Fan-Assisted Furnace Input: 100,000 Btu/h  
Draft-Hood-Equipped Water Heater Input:  
40,000 Btu/h

#### Solution

- (1) Determine the total available room volume:  
Equipment room volume: 15 ft x 30 ft with an 8 ft ceiling = 3600 ft<sup>3</sup>
- (2) Determine the total required volume: The standard method to determine combustion air will be used to calculate the required volume.



The combined input for the appliances located in the basement is calculated as follows:

100,000 Btu/h + 40,000 Btu/h = 140,000 Btu/h  
 The Standard Method requires that the required volume be determined based on 50 cubic feet per 1000 Btu/hour. Using Table A.8.3.2.1, the required volume for a 140,000 Btu/h water heater is 7,000 ft<sup>3</sup>.

Conclusion: Indoor volume is insufficient to supply combustion air since the total of 3600 ft<sup>3</sup> does not meet the required volume of 7000 ft<sup>3</sup>. Therefore, additional combustion air must be provided from the outdoors.

- (3) Determine ratio of the available volume to the required volume:

$$\frac{3600 \text{ ft}^3}{7000 \text{ ft}^3} = 0.51$$

- (4) Determine the reduction factor to be used to reduce the full outdoor air opening size to the minimum required based on ratio of indoor spaces

$$1.00 - 0.51 \text{ (from Step 3)} = 0.49$$

- (5) Determine the single outdoor combustion air opening size as if all combustion air is to come from outdoors. In this example, the combustion air opening directly communicates with the outdoors.

$$\frac{140,000 \text{ Btu/h}}{3,000 \text{ Btu/in}^2} = 47 \text{ in.}^2$$

- (6) Determine the minimum outdoor combustion air opening area:

$$\text{Outdoor opening area} = 0.49 \text{ (from Step 4)} \times 47 \text{ in.}^2 = 23 \text{ in.}^2$$

Section 507.3 requires the minimum dimension of the air opening should not be less than 3 in.

**TABLE A.8.3.2.1**  
**Standard Method Volume, All Appliances**

Appliance Input (Btu/h)	Required Volume (ft. <sup>3</sup> )
5,000	250
10,000	500
15,000	750
20,000	1,000
25,000	1,250
30,000	1,500
35,000	1,750
40,000	2,000
45,000	2,250
50,000	2,500
55,000	2,750
60,000	3,000
65,000	3,250
70,000	3,500
75,000	3,750
80,000	4,000
85,000	4,250
90,000	4,500
95,000	4,750
100,000	5,000
105,000	5,250
110,000	5,500
115,000	5,750
120,000	6,000
125,000	6,250
130,000	6,500
135,000	6,750
140,000	7,000
145,000	7,250
150,000	7,500
160,000	8,000
170,000	8,500
180,000	9,000
190,000	9,500
200,000	10,000
210,000	10,500
220,000	11,000
230,000	11,500
240,000	12,000
250,000	12,500
260,000	13,000
270,000	13,500
280,000	14,000
290,000	14,500
300,000	15,000

507.4.1 See Figure 5-8 • 507.4.1(1) See Figure 5-9 and Figure 5-10 • 507.4.1(2) See Figure 5-11 • 507.4.2 See Figure 5-12 • For information on gas convenience outlets, see AGA 7-90, *Requirements for Gas Convenience Outlets*.

# CHAPTER 6

## WATER SUPPLY AND DISTRIBUTION

### 601.0 Running Water Required.

**601.1** Except where not deemed necessary for safety or sanitation by the Authority Having Jurisdiction, each plumbing fixture shall be provided with an adequate supply of potable running water piped thereto in an approved manner, so arranged as to flush and keep it in a clean and sanitary condition without danger of backflow or cross-connection. Water closets and urinals shall be flushed by means of an approved flush tank or flushometer valve. In jurisdictions which adopt Appendix J, water closets, urinals, and trap primers in designated non-residential buildings may be provided with reclaimed water as defined and regulated by Appendix J of this code.

**601.2 Identification of a Potable and Nonpotable Water System.** In all buildings where potable water and nonpotable water systems are installed, each system shall be clearly identified. Each system shall be color coded as follows:

**601.2.1 Potable Water** – Green background with white lettering.

**601.2.2 Nonpotable Water** – Yellow background with black lettering, with the words “Caution: Nonpotable water, do not drink.”

Each system shall be identified with a colored band to designate the liquid being conveyed, and the direction of normal flow shall be clearly shown. The minimum size of the letters and length of the color field shall conform to Table 6-1.

A colored identification band shall be indicated every twenty (20) feet (6096 mm) but at least once per room, and shall be visible from the floor level.

Where vacuum breakers or backflow preventers are installed with fixtures listed in Table 14-1, identification of the discharge side may be omitted. Each outlet on the nonpotable water line which could be used for special purposes shall be posted as follows:

“Caution: Nonpotable water, do not drink.”

**601.2.3 Reclaimed Water** – Purple (Pantone color #512) background and shall be imprinted in nominal 1/2 in. (12.7 mm) high, black upper case letters, with the words “Caution: Reclaimed water, do not drink.”

**601.3** Faucets and diverters shall be connected to the water distribution system so that hot water corresponds to the left side of the fittings.

**TABLE 6-1**

**Minimum Length of Color Field and Size of Letters**

Outside Diameter of Pipe or Covering		Minimum Length of Color Field		Minimum Size of Letters	
inches	(mm)	inches	(mm)	inches	(mm)
1/2 to 1-1/4	(15 to 32)	8	(203)	1/2	(12.7)
1-1/2 to 2	(40 to 50)	8	(203)	3/4	(19.1)
2-1/2 to 6	(65 to 150)	12	(305)	1-1/4	(32)
8 to 10	(200 to 250)	24	(619)	2-1/2	(64)
Over 10	(Over 250)	32	(813)	3-1/2	(89)

### 602.0 Unlawful Connections

**602.1** No installation of potable water supply piping or part thereof shall be made in such a manner that it will be possible for used, unclean, polluted, or contaminated water, mixtures, or substances to enter any portion of such piping from any tank, receptor, equipment, or plumbing fixture by reason of back-siphonage, suction, or any other cause, either during normal use and operation thereof or when any such tank, receptor, equipment, or plumbing fixture is flooded or subject to pressure in excess of the operating pressure in the hot or cold water piping.

**602.2** No person shall make a connection or allow one to exist between pipes or conduits carrying domestic water supplied by any public or private water service system, and any pipes, conduits, or fixtures containing or carrying water from any other source or containing or carrying water which has been used for any purpose whatsoever, or any piping carrying chemicals, liquids, gases, or any substances whatsoever, unless there is provided a backflow prevention device approved for the potential hazard and maintained in accordance with this code.

**602.3** No plumbing fixture, device, or construction shall be installed or maintained or shall be connected to any domestic water supply when such installation or connection may provide a possibility of polluting such water supply or may provide a cross-connection between a distributing system of water for drinking and domestic purposes and water which may become contaminated by such plumbing fixture, device, or construction unless there is provided a backflow prevention device approved for the potential hazard.

**602.4** No water piping supplied by any private water supply system shall be connected to any other

source of supply without the approval of the Authority Having Jurisdiction, Health Department, or other Department Having Jurisdiction.

**603.0 Cross-Connection Control.**

Cross-connection control shall be provided in accordance with the provisions of this chapter.

No person shall install any water operated equipment or mechanism, or use any water-treating chemical or substance, if it is found that such equipment, mechanism, chemical, or substance may cause pollution or contamination of the domestic water supply. Such equipment or mechanism may be permitted only when equipped with an approved backflow prevention device or assembly.

**603.1 Approval of Devices or Assemblies.** Before any device or assembly is installed for the prevention of backflow, it shall have first been approved by the Authority Having Jurisdiction. Devices or assemblies shall be tested for conformity with recognized standards or other standards acceptable to the Authority Having Jurisdiction which are consistent with the intent of this code.

All devices or assemblies installed in a potable water supply system for protection against backflow shall be maintained in good working condition by the person or persons having control of such devices or assemblies. The Authority Having Jurisdiction or other department having jurisdiction may inspect such devices or assemblies and, if found to be

**TABLE 6-2  
Backflow Prevention Devices, Assemblies, and Methods**

Device, Assembly, or Method <sup>1</sup>	Degree of Hazard				Installation <sup>2,3</sup>
	Pollution (Low Hazard)		Contamination (High Hazard)		
	Back-Siphonage	Back-Pressure	Back-Siphonage	Back-Pressure	
Airgap	x		x		See Table 6-3 in this chapter
Atmospheric Vacuum Breaker	x		x		Upright position. No valve downstream. Minimum of six (6) inches (152 mm) or listed distance above all downstream piping and flood-level rim of receptor. <sup>4,5</sup>
Spill-Proof Pressure-Type Vacuum Breaker	x		x		Upright position. Minimum of six (6) inches (152 mm) or listed distance above all downstream piping and flood-level rim of receptor. <sup>5</sup>
Double Check Valve Backflow Preventer	x	x			Horizontal, unless otherwise listed. Requires one (1) foot (305 mm) minimum clearance at bottom for maintenance. May need platform/ladder for test and repair. Does not discharge water.
Pressure Vacuum Breaker	x		x		Upright position. May have valve downstream. Minimum of twelve (12) inches (305 mm) above all downstream, piping and flood-level rim of receptor. May discharge water.
Reduced Pressure Principle Backflow Preventer	x	x	x	x	Horizontal unless otherwise listed. Requires one (1) foot (305 mm) minimum clearance at bottom for maintenance. May need platform ladder for test and repair. May discharge water.

<sup>1</sup> See description of devices and assemblies in this chapter.

<sup>2</sup> Installation in pit or vault requires previous approval by the Authority Having Jurisdiction.

<sup>3</sup> Refer to general and specific requirement for installation.

<sup>4</sup> Not to be subjected to operating pressure for more than 12 hours in any 24 hour period.

<sup>5</sup> For deck-mounted and equipment-mounted vacuum breaker, see Section 603.4.16.

defective or inoperative, shall require the repair or replacement thereof. No device or assembly shall be removed from use or relocated or other device or assembly substituted, without the approval of the Authority Having Jurisdiction.

**603.2 Backflow Prevention Devices, Assemblies, and Methods.**

**603.2.1 Airgap.** The minimum airgap to afford backflow protection shall be in accordance with Table 6-3.

**603.2.2 Atmospheric Vacuum Breaker (AVB).** An atmospheric vacuum breaker consists of a body, a checking member, and an atmospheric opening.

**603.2.3 Hose Connection Backflow Preventer.** A hose connection backflow preventer consists of two independent check valves with an independent atmospheric vent between and a means of field testing and draining.

**603.2.4 Double Check Valve Backflow Prevention Assembly (DC).** A double check valve backflow prevention assembly consists of two independently acting internally loaded check valves, four properly located test cocks, and two isolation valves.

**603.2.5 Pressure Vacuum Breaker Backflow Prevention Assembly (PVB).** A pressure vacuum breaker backflow prevention assembly consists of a loaded air inlet valve, an internally loaded check valve, two (2) properly located test cocks, and two (2) isolation valves. This device shall be installed outdoors only if provisions for spillage are provided.

**603.2.6 Pressure Vacuum Breaker Spill-Proof Type Backflow Prevention Assembly (SVB).** A pressure type vacuum breaker backflow prevention assembly consisting of one (1) check valve force-loaded closed and an air inlet vent valve force-loaded open to atmosphere,

**TABLE 6-3**  
**Minimum Airgaps for Water Distribution<sup>4</sup>**

Fixtures	When not affected by side walls <sup>1</sup>		When affected by side wall <sup>2</sup>	
	Inches	(mm)	Inches	(mm)
Effective openings <sup>3</sup> not greater than one-half (1/2) inch (12.7 mm) in diameter	1	(25.4)	1-1/2	(38)
Effective openings <sup>3</sup> not greater than three-quarters (3/4) inch (20 mm) in diameter	1-1/2	(38)	2-1/4	(57)
Effective openings <sup>3</sup> not greater than one (1) inch (25 mm) in diameter	2	(51)	3	(76)
Effective openings <sup>3</sup> greater than one (1) inch (25 mm) in diameter	Two (2) times diameter of effective opening		Three (3) times diameter of effective opening	

<sup>1</sup> Side walls, ribs, or similar obstructions do not affect airgaps when spaced from the inside edge of the spout opening a distance greater than three times the diameter of the effective opening for a single wall, or a distance greater than four times the effective opening for two intersecting walls.

<sup>2</sup> Vertical walls, ribs, or similar obstructions extending from the water surface to or above the horizontal plane of the spout opening other than specified in Note 1 above. The effect of three or more such vertical walls or ribs has not been determined. In such cases, the airgap shall be measured from the top of the wall.

<sup>3</sup> The effective opening shall be the minimum cross-sectional area at the seat of the control valve or the supply pipe or tubing which feeds the device or outlet. If two or more lines supply one outlet, the effective opening shall be the sum of the cross-sectional areas of the individual supply lines or the area of the single outlet, whichever is smaller.

<sup>4</sup> Airgaps less than one (1) inch (25.4 mm) shall be approved only as a permanent part of a listed assembly that has been tested under actual backflow conditions with vacuums of 0 to 25 inches (635 mm) of mercury.

positioned downstream of the check valve, and located between and including two (2) tightly closing shutoff valves and test cocks.

**603.2.7 Reduced Pressure Principle Backflow Prevention Assembly (RP).** A reduced pressure principle backflow prevention assembly consists of two independently acting internally loaded check valves, a differential pressure relief valve, four properly located test cocks, and two isolation valves.

### 603.3 General Requirements.

**603.3.1** All assemblies shall conform to listed standards and be acceptable to the Authority Having Jurisdiction with jurisdiction over the selection and installation of backflow prevention assemblies.

**603.3.2** Where more than one (1) backflow prevention valve is installed on a single premise, and the valves are installed in one location, each separate valve shall be permanently identified by the permittee in a manner satisfactory to the Authority Having Jurisdiction.

**603.3.3** The premise owner or responsible person shall have the backflow prevention assembly tested by a certified backflow assembly tester at the time of installation, repair, or relocation and at least on an annual schedule thereafter or more often when required by the Authority Having Jurisdiction. The periodic testing shall be performed in accordance with the procedures referenced in Table 14-1 by a tester qualified in accordance with those standards.

**603.3.4** Access and clearance shall be provided for the required testing, maintenance, and repair. Access and clearance shall require a minimum of one (1) foot (305 mm) between the lowest portion of the assembly and grade, floor, or platform. Installations elevated more than five (5) feet (1524 mm) above the floor or grade shall be provided with a permanent platform capable of supporting a tester or maintenance person.

**603.3.5** Direct connections between potable water piping and sewer connected wastes shall not exist under any condition with or without backflow protection. Where potable water is discharged to the drainage system it shall be by means of an approved airgap of two (2) pipe diameters of the supply inlet, but in no case shall the gap be less than one (1) inch (25 mm). Connection may be made to the inlet side of a trap provided that an approved vacuum breaker is installed not less than six (6) inches (152 mm) or the distance according to the device's listing, above the flood-level rim of such trapped fixture, so that at no time will any such device be subjected to any back-pressure.

**603.3.6** Backflow preventers for hot water over 110°F (43.3°C) shall be a type designed to operate at temperatures of 110°F (43.3°C) or more without rendering any portion of the assembly inoperative.

**603.3.7** Fixtures, appliances, or appurtenances with integral backflow preventers or integral airgaps manufactured as a unit shall be installed in accordance with their listing requirements and the manufacturers' instructions.

**603.3.8** In cold climate areas, backflow assemblies and devices shall be protected from freezing by a method acceptable to the Authority Having Jurisdiction.

### 603.4 Specific Requirements.

**603.4.1** Water closet and urinal flushometer valves shall be equipped with an atmospheric vacuum breaker. The vacuum breaker shall be installed on the discharge side of the flushometer valve with the critical level at least six (6) inches (152 mm) or the distance according to its listing above the overflow rim of a water closet bowl or the highest part of a urinal.

**603.4.2** Water closet and urinal tanks shall be equipped with a ballcock. The ballcock shall be installed with the critical level at least one (1) inch (25.4 mm) above the full opening of the overflow pipe. In cases where the ballcock has no hush tube, the bottom of the water supply inlet shall be installed one (1) inch (25.4 mm) above the full opening of the overflow pipe.

**603.4.3** Water closet flushometer tanks shall be protected against backflow by an approved backflow prevention assembly, device, or method.

#### 603.4.4 Heat Exchangers.

**603.4.4.1** Heat exchangers used for heat transfer, heat recovery, or solar heating shall protect the potable water system from being contaminated by the heat transfer medium. Double-wall heat exchangers shall separate the potable water from the heat transfer medium by providing a space between the two walls which is vented to the atmosphere.

**603.4.5** Water supply inlets to tanks, vats, sumps, swimming pools, and other receptors shall be protected by one of the following means:

- (1) An approved airgap;
- (2) A listed vacuum breaker installed on the discharge side of the last valve with the critical level not less than six (6) inches (152 mm) or in accordance with its listing;
- (3) A backflow preventer suitable for the contamination or pollution, installed in

accordance with the requirements for that type of device or assembly as set forth in this chapter.

**603.4.6 Protection from Lawn Sprinklers and Irrigation Systems.**

**603.4.6.1** Potable water supplies to systems having no pumps or connections for pumping equipment, and no chemical injection or provisions for chemical injection, shall be protected from backflow by one of the following devices:

- (1) Atmospheric vacuum breaker
- (2) Pressure vacuum breaker
- (3) Reduced pressure backflow preventer

**603.4.6.2** Where sprinkler and irrigation systems have pumps, connections for pumping equipment, or auxiliary air tanks or are otherwise capable of creating back-pressure, the potable water supply shall be protected by the following type of device if the backflow device is located upstream from the source of back-pressure:

- (1) Reduced pressure backflow preventer

**603.4.6.3** Where systems have a backflow device installed downstream from a potable water supply pump or a potable water supply pump connection, the device shall be one of the following:

- (1) Atmospheric vacuum breaker
- (2) Pressure vacuum breaker
- (3) Reduced pressure backflow preventer

**603.4.6.4** Where systems include a chemical injector or any provisions for chemical injection, the potable water supply shall be protected by the following:

- (1) Reduced pressure backflow preventer

**603.4.7** Potable water outlets with hose attachments, other than water heater drains, boiler drains, and clothes washer connections, shall be protected by a non-removable hose bibb type backflow preventer, a non-removable hose bibb type vacuum breaker, or by an atmospheric vacuum breaker installed at least six (6) inches (152 mm) above the highest point of usage located on the discharge side of the last valve. In climates where freezing temperatures occur, a listed self-draining frost-proof hose bibb with an integral backflow preventer or vacuum breaker shall be used.

**603.4.8 DELETED.**

**603.4.9** Water cooled compressors, de-greasers or any other water cooled equipment shall be

protected by a backflow preventer installed in accordance with the requirements of this chapter.

**Note:**

Water cooled equipment which produces back-pressure shall be equipped with the appropriate protection.

**603.4.10** Water inlets to water supplied aspirators shall be equipped with a vacuum breaker installed in accordance with its listing requirements and this chapter. The discharge shall drain through an air gap. When the tailpiece of a fixture to receive the discharge of an aspirator is used, the air gap shall be located above the flood-level rim of the fixture.

**603.4.11** Potable water make up connections to steam or hot water boilers shall be provided with a listed backflow protection assembly.

**603.4.12 Nonpotable Water Piping.** In cases where it is impractical to correct individual cross-connections on the domestic water line, the line supplying such outlets shall be considered a non-potable water line. No drinking or domestic water outlets shall be connected to the non-potable water line. Whenever possible, all portions of the non-potable water line shall be exposed, and all exposed portions shall be properly identified in a manner satisfactory to the Authority Having Jurisdiction. Each outlet on the non-potable water line which may be used for drinking or domestic purposes shall be posted: "Caution: Non-potable water, do not drink."

**603.4.13** Potable water supply to carbonators shall be protected by either an airgap or a vented backflow preventer for carbonated beverage dispensers installed within the carbonated beverage dispenser. The carbonated beverage dispenser shall bear the label of an approved testing agency, certifying and attesting that such equipment has been tested and inspected and meets the requirements of the approved applicable standard. Carbonated beverage dispensers without an approved internal airgap or vented backflow preventer for carbonated beverage dispensers and carbonated beverage dispensing systems shall have the water supply protected with a vented backflow preventer for carbonated beverage dispensers.

**603.4.14 Water Treatment Units.** Reverse osmosis drinking water treatment units shall meet the requirements of the appropriate standards referenced in Table 14-1. Waste or discharge from reverse osmosis or other types of water treatment units shall enter the drainage system through an airgap.

**603.4.15** Backflow preventers shall not be located in any area containing fumes that are toxic, poisonous, or corrosive.

**603.4.16** Deck-mounted or equipment-mounted vacuum breakers shall be installed in accordance with their listing and the manufacturers' instructions, with the critical level not less than one (1) inch (25.4 mm) above the flood-level rim.

**603.4.17** DELETED.

**603.4.18 Protection from Fire Systems.**

**603.4.18.1** Except as provided under Sections 603.4.18.2 and 603.4.18.3, potable water supplies to fire protection systems that are normally under pressure, including but not limited to standpipes and automatic sprinkler systems, except in one- or two-family residential sprinkler systems, piped in materials approved for potable water distribution systems shall be protected from back-pressure and back-siphonage by one of the following testable devices:

- (1) Double check valve assembly
- (2) Double check detector assembly
- (3) Reduced pressure backflow preventer
- (4) Reduced pressure detector assembly

Potable water supplies to fire protection systems that are not normally under pressure shall be protected from backflow and shall meet the requirements of the appropriate standards referenced in Table 14-1.

**603.4.18.2** Where fire protection systems supplied from a potable water system include a fire department (siamese) connection which is located less than seventeen hundred (1700) feet (518.2 m) from a non-potable water source that could be used by the fire department as a secondary water supply, the potable water supply shall be protected by one of the following:

- (1) Reduced pressure backflow preventer
- (2) Reduced pressure detector assembly

**Note:**

Non-potable water sources include fire department vehicles carrying water of questionable quality or water that is treated with antifreeze, corrosion inhibitors, or extinguishing agents.

**603.4.18.3** Where antifreeze, corrosion inhibitors, or other chemicals are added to a fire protection system supplied from a potable water supply, the potable water system shall be protected by one of the following:

- (1) Reduced pressure backflow preventer
- (2) Reduced pressure detector assembly.

**603.4.18.4** Whenever a backflow device is installed in the potable water supply to a fire protection system, the hydraulic design of the system shall account for the pressure drop through the backflow device. If such devices are retrofitted for an existing fire protection system, the hydraulics of the sprinkler system design shall be checked to verify that there will be sufficient water pressure available for satisfactory operation of the fire sprinklers.

**603.4.18.5 Residential Sprinkler Systems.**

When residential sprinkler systems are installed using the potable water system, they shall be installed in accordance with the standards listed in Table 14-1.

**603.4.19 Special Equipment, Water Supply Protection.** Vacuum breakers for washer-hose bedpans shall be located not less than five (5) feet (1524 mm) above the floor. Hose connections in health care or laboratory areas shall not be less than six (6) feet (1829 mm) above the floor.

**603.4.20** Portable cleaning equipment, dental vacuum pumps, and chemical dispensers shall be protected from backflow by an airgap, an atmospheric vacuum breaker, a spill-proof vacuum breaker, or a reduced pressure principle backflow preventer.

**603.4.21 Water Heater Connectors.** Flexible metallic water heater connectors or reinforced flexible water heater connectors connecting water heaters to the piping system shall be in compliance with the appropriate standards listed in Table 14-1.

**603.4.22** Combination stop-and-waste valves or cocks shall not be installed underground.

**603.4.23 Pure Water Process Systems – (See TIA on page vii)**

**603.4.23.1 Dialysis Water Systems – (See TIA on page vii)**

**604.0 Materials.**

**604.1** Water distribution pipe, building supply water pipe, and fittings shall be of brass, copper, cast iron, CPVC, galvanized malleable iron, galvanized wrought iron, galvanized steel, PEX, or other approved materials. Asbestos-cement, PE, PVC, PEX-AL-PEX, or PE-AL-PE water pipe manufactured to recognized standards may be used for cold water building supply distribution systems outside a building. PEX-AL-PEX water pipe, tubing, and fittings manufactured to recognized standards may

be used for hot and cold water distribution systems within a building. PE-AL-PE water pipe and fittings may be used for cold water distribution systems within a building. All materials used in the water supply system, except valves and similar devices, shall be of a like material, except where otherwise approved by the Authority Having Jurisdiction.

**604.2** Copper tube for water piping shall have a weight of not less than Type L.

**Exception:** Type M copper tubing may be used for water piping when piping is above ground in, or on, a building or underground outside of structures.

**604.3** All hard-drawn copper tubing, in addition to the required incised marking, shall be marked in accordance with sections 19.3.1 and 19.3.2 of ASTM B 88-99 *Seamless Copper Water Tube*. The colors shall be: Type K, green; Type L, blue; Type M, red; Type DWV, yellow.

**604.4** Listed flexible copper water connectors shall be installed in readily accessible locations, unless otherwise listed.

**604.5** Cast iron fittings up to and including two (2) inches (51 mm) in size, when used in connection with potable water piping, shall be galvanized.

**604.6** All malleable iron water fittings shall be galvanized.

**604.7** Piping and tubing which has previously been used for any purpose other than for potable water systems shall not be used.

**604.8** Approved plastic materials may be used in water service piping, provided that where metal water service piping is used for electrical grounding purposes, replacement piping therefor shall be of like materials.

**Exception:** Where a grounding system acceptable to the Authority Having Jurisdiction is installed, inspected, and approved, metallic pipe may be replaced with non-metallic pipe.

**604.9** Solder shall conform to the requirements of Section 316.1.3.

**604.10** Water pipe and fittings with a lead content which exceeds eight (8) percent shall be prohibited in piping systems used to convey potable water.

**604.11 PEX.** Cross-linked polyethylene (PEX) tubing shall be marked with the appropriate standard designation(s) listed in Table 14-1 for which the tubing has been approved. PEX tubing shall be installed in compliance with the provisions of this section.

**604.11.1 PEX Fittings.** Metal insert fittings, metal compression fittings, and cold expansion fittings used with PEX tubing shall be manufactured to and marked in accordance with the standards for the fittings in Table 14-1.

**604.11.2 Water Heater Connections.** PEX tubing shall not be installed within the first eighteen (18) inches (457 mm) of piping connected to a water heater.

**604.12 Flexible Corrugated Connectors.** Flexible corrugated connectors of copper or stainless steel shall be limited to the following connector lengths:

**Water Heater Connectors** – twenty-four (24) inches (609 mm).

**Fixture Connectors** – thirty (30) inches (762 mm).

**Washing Machine Connectors** – seventy-two (72) inches (1827 mm).

**Dishwasher and Icemaker Connectors** – one hundred twenty (120) inches (3048 mm).

**604.13 PEX-AL-PEX and PE-AL-PE.** Crosslinked polyethylene-aluminum-crosslinked polyethylene (PEX-AL-PEX) and polyethylene-aluminum-polyethylene (PE-AL-PE) composite pipe shall be marked with the appropriate standard designations listed in Table 14-1 for which the piping has been listed or approved. PEX-AL-PEX and PE-AL-PE piping shall be installed in compliance with the provisions of this section.

**604.13.1 PEX-AL-PEX and PE-AL-PE.** Fittings used with PEX-AL-PEX and PE-AL-PE piping shall be manufactured to and marked in accordance with the standard for the fittings in Table 14-1.

**604.13.2 Water Heater Connections.** PEX-AL-PEX or PE-AL-PE tubing shall not be installed within the first eighteen inches (18) (457 mm) of piping connected to a water heater.

**604.14 Dialysis Water System** – (See TIA on page vii)

**605.0 Valves.**

**605.1** Valves up to and including two (2) inches (51 mm) in size shall be brass or other approved material. Sizes over two (2) inches (51 mm) may have cast iron or brass bodies. Each gate or ball valve shall be a fullway type with working parts of noncorrosive material.

**605.2** A fullway valve controlling all outlets shall be installed on the discharge side of each water meter and on each unmetered water supply. Water piping supplying more than one building on any one premises shall be equipped with a separate fullway valve to each building, so arranged that the water supply can be turned on or off to any individual or separate building provided, however, that supply piping to a single-family residence and building accessory thereto, may be controlled on one valve. Such shutoff valves shall be accessible at all times. A fullway valve shall be installed on the discharge piping from water supply tanks at or near the tank. A fullway valve shall be installed on the



cold water supply pipe to each water heater at or near the water heater.

**605.3** In multi-dwelling units, one (1) or more shutoff valves shall be provided in each dwelling unit so that the water supply to any plumbing fixture or group of fixtures in that dwelling unit can be shut off without stopping water supply to fixtures in other dwelling units. These valves shall be accessible in the dwelling unit that they control.

**605.4** All valves used to control two (2) or more openings shall be fullway gate valves, ball valves, or other approved valves designed and approved for the service intended.

**605.5** A control valve shall be installed immediately ahead of each water-supplied appliance and immediately ahead of each slip joint or appliance supply.

Parallel water distribution systems shall provide a control valve either immediately ahead of each fixture being supplied or installed at the manifold and shall be identified with the fixture being supplied.

**605.6** All required shutoff or control valves shall be accessible.

**605.7** A single control valve shall be installed on a water supply line ahead of any automatic metering valve which supplies a battery of fixtures.

## 606.0 Joints and Connections.

### 606.1 Types of Joints.

**606.1.1 Flared Joints.** Flared joints for soft copper water tubing shall be made with fittings meeting approved standards. The tubing shall be reamed to the full bore, resized to round, and expanded with a proper flaring tool.

**606.1.2 Mechanical Joints.** Mechanical joints for cast iron water pipe shall conform to nationally recognized standards.

**606.1.3 Mechanically Formed Tee Fittings.** Mechanically extracted collars shall be formed in a continuous operation consisting of drilling a pilot hole and drawing out the tube surface to form a collar having a height not less than three (3) times the thickness of the branch tube wall.

The branch tube shall be notched to conform with the inner curve of the run tube and shall have two (2) dimple/depth stops to ensure that penetration of the branch tube into the collar is of sufficient depth for brazing and that the branch tube does not obstruct the flow in the main line tube. Dimple/depth stops shall be in line with the run of the tube. The second dimple shall be one quarter (1/4) inch (6.35 mm) above the first and

shall serve as a visual point of inspection.

All joints shall be brazed in accordance with Section 316.1.7. Soft soldered joints shall not be allowed.

## 606.1.4 –Dialysis Water Systems (See TIA onpage vii)

### 606.2 Use of Joints.

**606.2.1 Copper Water Tube.** Joints in copper tubing shall be made by the appropriate use of approved fittings properly soldered or brazed together as provided in Section 316.1.3 or 316.1.7 or by means of approved flared or compression fittings in Section 606.1.1 or 606.1.3. Solder and soldering flux shall conform to the requirements of Section 316.1.3. Mechanically formed tee fittings shall be made by brazing only and shall conform to the requirements of Section 316.1.7.

**606.2.2 Plastic Fittings.** Female PVC screwed fittings for water piping shall be used with plastic male fittings and plastic male threads only.

**606.2.3 Slip Joints.** In water piping, slip joints may be used only on the exposed fixture supply.

### 607.0 Gravity Supply Tanks.

Gravity tanks for potable water shall be tightly covered, and have not less than a sixteen (16) square inch (10,323 mm<sup>2</sup>) overflow screened with copper screen having not less than fourteen (14) nor more than eighteen (18) openings per linear inch (25.4 mm).

## 608.0 Water Pressure, Pressure Regulators, Pressure Relief Valves, and Vacuum Relief Valves.

**608.1 Inadequate Water Pressure.** Whenever the water pressure in the main or other source of supply will not provide a residual water pressure of at least fifteen (15) pounds per square inch (103.4 kPa), after allowing for friction and other pressure losses, a tank and a pump or other means which will provide said fifteen (15) pound (103.4 kPa) pressure shall be installed. Whenever fixtures and/or fixture fittings are installed that require residual pressure higher than fifteen (15) pounds per square inch (103.4 kPa), that minimum residual pressure shall be provided.

**608.2 Excessive Water Pressure.** Where local static water pressure is in excess of eighty (80) pounds per square inch (552 kPa), an approved type pressure regulator preceded by an adequate strainer shall be installed and the static pressure reduced to eighty (80) pounds per square inch (552 kPa) or less. For potable water services up to and including one and one-half (1-1/2) inch (40 mm) regulators, provision shall be made to prevent pressure on the building side of the regulator from exceeding main supply pressure. Approved regulators with integral

bypasses shall be acceptable. Each such regulator and strainer shall be accessibly located and shall have the strainer readily accessible for cleaning without removing the regulator or strainer body or disconnecting the supply piping. All pipe size determinations shall be based on eighty (80) percent of the reduced pressure when using Table 6-5.

**608.3** Any water system provided with a check valve, backflow preventer, or a pressure-regulating device which does not have a bypass feature at its source shall be provided with an approved, listed adequately sized pressure relief valve or a means to control expansion.

Any water system containing storage water heating equipment shall be provided with an approved, listed adequately sized combination pressure and temperature relief valve, except for listed non-storage instantaneous heaters having an inside diameter of not more than three (3) inches (80 mm). Each such approved combination temperature and pressure relief valve shall be installed on the water-heating device in an approved location based on its listing requirements and the manufacturer's instructions. Each such combination temperature and pressure relief valve shall be provided with a drain as required in Section 608.5.

In addition to the required pressure or combination pressure and temperature relief valve, an approved, listed expansion tank or other device designed for intermittent operation for thermal expansion control shall be installed whenever the building supply pressure is greater than the required relief valve pressure setting or when any device is installed that prevents pressure relief through the building supply. The tank or device shall be sized in accordance with the manufacturer's recommendation.

**608.4** Each pressure relief valve shall be an approved automatic type with drain, and each such relief valve shall be set at a pressure of not more than one hundred fifty (150) pounds per square inch (1035 kPa). No shutoff valve shall be installed between the relief valve and the system or in the drain line.

**608.5** Relief valves located inside a building shall be provided with a drain, not smaller than the relief valve outlet, of galvanized steel, hard-drawn copper piping and fittings, CPVC, or listed relief valve drain tube with fittings which will not reduce the internal bore of the pipe or tubing (straight lengths as opposed to coils) and shall extend from the valve to the outside of the building with the end of the pipe not more than two (2) feet (610 mm) nor less than six (6) inches (152 mm) above the ground or the flood level of the area receiving the discharge and pointing downward. Such drains may terminate at other approved locations. No part of such drain pipe shall

be trapped or subject to freezing. The terminal end of the drain pipe shall not be threaded.

**608.6** Any water-heating device connected to a separate storage tank and having valves between said heater and tank shall be provided with an approved water pressure relief valve.

**608.7 Vacuum Relief Valves.** Where a hot-water storage tank or an indirect water heater is located at an elevation above the fixture outlets in the hot-water system, a vacuum relief valve shall be installed on the storage tank or heater.

#### **609.0 Installation, Testing, Unions, and Location.**

**609.1 Installation.** All water piping shall be adequately supported in accordance with Section 314.0. Burred ends shall be reamed to the full bore of the pipe or tube. Changes in direction shall be made by the appropriate use of fittings, except that changes in direction in copper tubing may be made with bends, provided that such bends are made with bending equipment which does not deform or create a loss in the cross-sectional area of the tubing. Changes in direction are allowed with flexible pipe and tubing without fittings in accordance with the manufacturer's installation instructions. Provisions shall be made for expansion in hot-water piping. All piping, equipment, appurtenances, and devices shall be installed in a workmanlike manner in conformity with the provisions and intent of the code. All water service yard piping shall be at least twelve (12) inches (305 mm) below the average local frost depth. The minimum cover shall be twelve (12) inches (305 mm) below finish grade.

**609.2** Water pipes shall not be run or laid in the same trench as building sewer or drainage piping constructed of clay or materials which are not approved for use within a building unless both of the following conditions are met:

**609.2.1** The bottom of the water pipe, at all points, shall be at least twelve (12) inches (305 mm) above the top of the sewer or drain line.

**609.2.2** The water pipe shall be placed on a solid shelf excavated at one side of the common trench with a minimum clear horizontal distance of at least twelve (12) inches (305 mm) from the sewer or drain line.

Water pipes crossing sewer or drainage piping constructed of clay or materials which are not approved for use within a building shall be laid a minimum of twelve (12) inches (305 mm) above the sewer or drain pipe.

**609.3** Water piping installed within a building and in or under a concrete floor slab resting on the ground shall be installed in accordance with the following requirements:

**609.3.1** Ferrous piping shall have a protective coating of an approved type, machine applied and conforming to recognized standards. Field wrapping shall provide equivalent protection and shall be restricted to those short sections and fittings necessarily stripped for threading. Zinc coating (galvanizing) shall not be deemed adequate protection for piping or fittings. Approved non-ferrous piping shall not be required to be wrapped.

**609.3.2** Copper tubing shall be installed without joints where possible. Where joints are permitted, they shall be brazed, and fittings shall be wrought copper.

**Note:**

For the purpose of this section, "within the building" shall mean within the fixed limits of the building foundation.

**609.4 Testing.** Upon completion of a section or of the entire hot and cold water supply system, it shall be tested and proved tight under a water pressure not less than the working pressure under which it is to be used. The water used for tests shall be obtained from a potable source of supply. Except for plastic piping, a fifty (50) pound per square inch (344.5 kPa) air pressure may be substituted for the water test. In either method of test, the piping shall withstand the test without leaking for a period of not less than fifteen (15) minutes.

**609.5 Unions.** Unions shall be installed in the water supply piping within twelve (12) inches (305 mm) of regulating equipment, water heating, conditioning tanks, and similar equipment which may require service by removal or replacement in a manner which will facilitate its ready removal.

**609.6 Location.** Except as provided in Section 609.7, no building supply shall be located in any lot other than the lot which is the site of the building or structure served by such building supply.

**609.7** Nothing contained in this code shall be construed to prohibit the use of all or part of an abutting lot to:

**609.7.1** Provide access to connect a building supply to an available public water service when proper cause and legal easement not in violation of other requirements have been first established to the satisfaction of the Authority Having Jurisdiction.

**609.7.2** Provide additional space for a building supply when proper cause, transfer of ownership, or change of boundary not in violation of other requirements have been first established to the satisfaction of the Authority Having Jurisdiction. The instrument recording

such action shall constitute an agreement with the Authority Having Jurisdiction, which shall clearly state and show that the areas so joined or used shall be maintained as a unit during the time they are so used. Such an agreement shall be recorded in the office of the County Recorder as a part of the conditions of ownership of said properties, and shall be binding on all heirs, successors, and assigns to such properties. A copy of the instrument recording such proceedings shall be filed with the Authority Having Jurisdiction.

**609.8 Low Pressure Cutoff Required on Booster Pumps for Water Distribution Systems.** When a booster pump – excluding a fire pump – is connected to a water service or underground water pipe, a low-pressure cutoff switch on the inlet side of the pump shall be installed within five (5) feet (1524 mm) of the inlet. The cutoff switch shall be set for not less than ten (10) psi (68.9 kPa) or as required by the Authority Having Jurisdiction. A pressure gauge shall be installed between the shutoff valve and the pump.

**609.9 Disinfection of Potable Water System.** New or repaired potable water systems shall be disinfected prior to use whenever required by the Authority Having Jurisdiction. The method to be followed shall be that prescribed by the Health Authority or, in case no method is prescribed by it, the following:

**609.9.1** The pipe system shall be flushed with clean, potable water until only potable water appears at the points of outlet.

**609.9.2** The system or parts thereof shall be filled with a water-chlorine solution containing at least fifty (50) parts per million of chlorine, and the system or part thereof shall be valved-off and allowed to stand for twenty-four (24) hours; or, the system or part thereof shall be filled with a water-chlorine solution containing at least two hundred (200) parts per million of chlorine and allowed to stand for three (3) hours.

**609.9.3** Following the allowed standing time, the system shall be flushed with clean, potable water until the chlorine residual in the water coming from the system does not exceed the chlorine residual in the flushing water.

**609.9.4** The procedure shall be repeated if it is shown by bacteriological examination made by an approved agency that contamination persists in the system.

**609.10 Water Hammer.** All building water supply systems in which quick-acting valves are installed shall be provided with devices to absorb the hammer caused by high pressures resulting from the quick closing of these valves. These pressure-absorbing

Inch	mm
1/2	15
3/4	20
1	25

**TABLE 6-4**  
**Water Supply Fixture Units (WSFU) and Minimum Fixture Branch Pipe Sizes<sup>3</sup>**

	Minimum Fixture Branch Pipe Size <sup>1,4</sup>	Private	Public	Assembly <sup>6</sup>
<b>Appliances, Appurtenances or Fixtures<sup>2</sup></b>				
Bathtub or Combination Bath/Shower (fill) .....	1/2"	4.0	4.0	
3/4" Bathtub Fill Valve .....	3/4"	10.0	10.0	
Bidet .....	1/2"	1.0		
Clothes washer .....	1/2"	4.0	4.0	
Dental Unit, cuspidor .....	1/2"		1.0	
Dishwasher, domestic .....	1/2"	1.5	1.5	
Drinking Fountain or Watercooler .....	1/2"	0.5	0.5	0.75
Hose Bibb .....	1/2"	2.5	2.5	
Hose Bibb, each additional <sup>8</sup> .....	1/2"	1.0	1.0	
Lavatory .....	1/2"	1.0	1.0	1.0
Lawn Sprinkler, each head <sup>5</sup> .....		1.0	1.0	
Mobile Home, each (minimum) .....		12.0		
<b>Sinks</b>				
Bar .....	1/2"	1.0	2.0	
Clinic Faucet .....	1/2"		3.0	
Clinic Flushometer Valve .....				
with or without faucet .....	1"		8.0	
Kitchen, domestic .....	1/2"	1.5	1.5	
Laundry .....	1/2"	1.5	1.5	
Service or Mop Basin .....	1/2"	1.5	3.0	
Washup, each set of faucets .....	1/2"		2.0	
Shower, per head .....	1/2"	2.0	2.0	
Urinal, 1.0 GPF Flushometer Valve .....	3/4"	See Footnote <sup>7</sup>		
Urinal, greater than 1.0 GPF Flushometer Valve .....	3/4"	See Footnote <sup>7</sup>		
Urinal, flush tank .....	1/2"	2.0	2.0	3.0
Washfountain, circular spray .....	3/4"		4.0	
Water Closet, 1.6 GPF Gravity Tank .....	1/2"	2.5	2.5	3.5
Water Closet, 1.6 GPF Flushometer Tank .....	1/2"	2.5	2.5	3.5
Water Closet, 1.6 GPF Flushometer Valve .....	1"	See Footnote <sup>7</sup>		
Water Closet, greater than 1.6 GPF Gravity Tank .....	1/2"	3.0	5.5	7.0
Water Closet, greater than 1.6 GPF Flushometer Valve .....	1"	See Footnote <sup>7</sup>		

**Notes:**

- <sup>1</sup> Size of the cold branch pipe, or both the hot and cold branch pipes.
- <sup>2</sup> Appliances, Appurtenances or Fixtures not included in this Table may be sized by reference to fixtures having a similar flow rate and frequency of use.
- <sup>3</sup> The listed fixture unit values represent their load on their cold water service. The separate cold water and hot water fixture unit value for fixtures having both hot and cold water connections may each be taken as three-quarter ( 3/4) of the listed total value of the fixture.
- <sup>4</sup> The listed minimum supply branch pipe sizes for individual fixtures are the nominal (I.D.) pipe size.
- <sup>5</sup> For fixtures or supply connections likely to impose continuous flow demands, determine the required flow in gallons per minute (GPM) and add it separately to the demand (in GPM) for the distribution system or portions thereof.
- <sup>6</sup> Assembly [Public Use (See Table 4-1)].
- <sup>7</sup> When sizing flushometer systems see Section 610.10.
- <sup>8</sup> Reduced fixture unit loading for additional hose bibbs as used is to be used only when sizing total building demand and for pipe sizing when more than one hose bibb is supplied by a segment of water distributing pipe. The fixture branch to each hose bibb shall be sized on the basis of 2.5 fixture units.

**TABLE 6-5**  
**Fixture Unit Table for Determining Water Pipe and Meter Sizes**

Inch	mm
1/2	15
3/4	20
1	25
1-1/4	32
1-1/2	40
2	50
2-1/2	65

**Pressure Range – 30 to 45 psi (207 to 310 kPa)\*\***

Meter and Street Service, Inches	Building Supply and Branches, Inches	Maximum Allowable Length in Feet (meters)															
		40 (12)	60 (18)	80 (24)	100 (30)	150 (46)	200 (61)	250 (76)	300 (91)	400 (122)	500 (152)	600 (183)	700 (213)	800 (244)	900 (274)	1000 (305)	
3/4	1/2***	6	5	4	3	2	1	1	1	0	0	0	0	0	0	0	
3/4	3/4	16	16	14	12	9	6	5	5	4	4	3	2	2	2	1	
3/4	1	29	25	23	21	17	15	13	12	10	8	6	6	6	6	6	
1	1	36	31	27	25	20	17	15	13	12	10	8	6	6	6	6	
3/4	1-1/4	36	33	31	28	24	23	21	19	17	16	13	12	12	11	11	
1	1-1/4	54	47	42	38	32	28	25	23	19	17	14	12	12	11	11	
1-1/2	1-1/4	78	68	57	48	38	32	28	25	21	18	15	12	12	11	11	
1	1-1/2	85	84	79	65	56	48	43	38	32	28	26	22	21	20	20	
1-1/2	1-1/2	150	124	105	91	70	57	49	45	36	31	26	23	21	20	20	
2	1-1/2	151	129	129	110	80	64	53	46	38	32	27	23	21	20	20	
1	2	85	85	85	85	85	85	82	80	66	61	57	52	49	46	43	
1-1/2	2	220	205	190	176	155	138	127	120	104	85	70	61	57	54	51	
2	2	370	327	292	265	217	185	164	147	124	96	70	61	57	54	51	
2	2-1/2	445	418	390	370	330	300	280	265	240	220	198	175	158	143	133	

**Pressure Range – 46 to 60 psi (317 to 414 kPa)\*\***

3/4	1/2***	7	7	6	5	4	3	2	2	1	1	1	0	0	0	0
3/4	3/4	20	20	19	17	14	11	9	8	6	5	4	4	3	3	3
3/4	1	39	39	36	33	28	23	21	19	17	14	12	10	9	8	8
1	1	39	39	39	36	30	25	23	20	18	15	12	10	9	8	8
3/4	1-1/4	39	39	39	39	39	39	34	32	27	25	22	19	19	17	16
1	1-1/4	78	78	76	67	52	44	39	36	30	27	24	20	19	17	16
1-1/2	1-1/4	78	78	78	78	66	52	44	39	33	29	24	20	19	17	16
1	1-1/2	85	85	85	85	85	85	80	67	55	49	41	37	34	32	30
1-1/2	1-1/2	151	151	151	151	128	105	90	78	62	52	42	38	35	32	30
2	1-1/2	151	151	151	151	150	117	98	84	67	55	42	38	35	32	30
1	2	85	85	85	85	85	85	85	85	85	85	85	85	85	83	80
1-1/2	2	370	370	340	318	272	240	220	198	170	150	135	123	110	102	94
2	2	370	370	370	370	368	318	280	250	205	165	142	123	110	102	94
2	2-1/2	654	640	610	580	535	500	470	440	400	365	335	315	285	267	250

**Pressure Range – Over 60 psi (414 kPa)\*\***

3/4	1/2***	7	7	7	6	5	4	3	3	2	1	1	1	1	1	0
3/4	3/4	20	20	20	20	17	13	11	10	8	7	6	6	5	4	4
3/4	1	39	39	39	39	35	30	27	24	21	17	14	13	12	12	11
1	1	39	39	39	39	38	32	29	26	22	18	14	13	12	12	11
3/4	1-1/4	39	39	39	39	39	39	39	39	34	28	26	25	23	22	21
1	1-1/4	78	78	78	78	74	62	53	47	39	31	26	25	23	22	21
1-1/2	1-1/4	78	78	78	78	78	74	65	54	43	34	26	25	23	22	21
1	1-1/2	85	85	85	85	85	85	85	85	81	64	51	48	46	43	40
1-1/2	1-1/2	151	151	151	151	151	151	130	113	88	73	51	51	46	43	40
2	1-1/2	151	151	151	151	151	151	142	122	98	82	64	51	46	43	40
1	2	85	85	85	85	85	85	85	85	85	85	85	85	85	85	85
1-1/2	2	370	370	370	370	360	335	305	282	244	212	187	172	153	141	129
2	2	370	370	370	370	370	370	370	340	288	245	204	172	153	141	129
2	2-1/2	654	654	654	654	654	650	610	570	510	460	430	404	380	356	329

\*\*Available static pressure after head loss.

\*\*\*Building supply, three-quarter (3/4) inch (20 mm) nominal size minimum.

**Table 6-6  
Minimum Required Air Chamber Dimensions**

Nominal Pipe Diameter	Length of Pipe (ft.)	Flow Pressure P.S.I.G.	Velocity in Ft. Per. Sec.	Required Vol. in Cubic Inch	Air Chamber Phys. Size in Inches
1/2"	(15 mm) 25	30	10	8	3/4" x 15"
1/2"	(15 mm) 100	60	10	60	1" x 69.5"
3/4"	(20 mm) 50	60	5	13	1" x 15"
3/4"	(20 mm) 200	30	10	108	1.25" x 72.5"
1"	(25 mm) 100	60	5	19	1.25" x 12.7"
1"	(25 mm) 50	30	10	40	1.25" x 27"
1-1/4"	(32 mm) 50	60	10	110	1.25" x 54"
1-1/2"	(40 mm) 200	30	5	90	2" x 27"
1-1/2"	(40 mm) 50	60	10	170	2" x 50.5"
2"	(50 mm) 100	30	10	329	3" x 44.5"
2"	(50 mm) 25	60	10	150	2.5" x 31"
2"	(50 mm) 200	60	5	300	3" x 40.5"

devices shall be either air chambers or approved mechanical devices. Water pressure absorbing devices shall be installed as close as possible to quick-acting valves.

**609.10.1 Air Chambers.** When air chambers are installed, they shall be in an accessible place, and each air chamber shall be provided with an accessible means for restoring the air in the event that the chamber becomes waterlogged. Air chambers shall be sized in accordance with Table 6-6.

**609.10.2 Mechanical Devices.** When listed mechanical devices are used, the manufacturer's specifications as to location and method of installation shall be followed. Such mechanical devices shall be accessible.

### 610.0 Size of Potable Water Piping.

**610.1** The size of each water meter and each potable water supply pipe from the meter or other source of supply to the fixture supply branches, risers, fixtures, connections, outlets, or other uses shall be based on the total demand and shall be determined according to the methods and procedures outlined in this section. Other than systems sized by the use of Table 6-5, the system shall be designed to assure that the maximum velocities allowed by the code and the applicable standard are not exceeded.

**610.2** Whenever a water filter, water softener backflow prevention device, or similar device is installed in any water supply line, the pressure loss through such devices shall be included in the pressure loss calculations of the system, and the

water supply pipe and meter shall be adequately sized to provide for any such pressure loss.

No water filter, water softener, backflow prevention device, or similar device regulated by this code shall be installed in any potable water supply piping when the installation of such device produces an excessive pressure drop in any such water supply piping. In the absence of specific pressure drop information, the diameter of the inlet or outlet of any such device or its connecting piping shall not be less than the diameter of such water distribution piping to the fixtures served by the device.

All such devices shall be of a type approved by the Authority Having Jurisdiction and shall be tested for flow rating and pressure loss by an approved laboratory or recognized testing agency to standards consistent with the intent of this chapter.

**610.3** The quantity of water required to be supplied to every plumbing fixture shall be represented by fixture units, as shown in Table 6-4. Equivalent fixture values shown in Table 6-4 include both hot and cold water demand.

**610.4** Systems within the range of Table 6-5 may be sized from that table or by the method set forth in Section 610.5.

Listed parallel water distribution systems shall be installed in accordance with their listing, but at no time shall any portion of the system exceed the maximum velocities allowed by the code.

**610.5** Except as provided in Section 610.4, the size of each water piping system shall be determined in accordance with the procedure set forth in Appendix A. For alternate methods of sizing water supply systems, see Appendix L.

**610.6** Except where the type of pipe used and the water characteristics are such that no decrease in capacity due to length of service (age of system) may be expected, all friction loss data shall be obtained from the "Fairly Rough" or "Rough" charts in Appendix A of this code. Friction or pressure losses in water meter, valve and fittings shall be obtained from the same sources. Pressure losses through water treating equipment, backflow prevention devices, or other flow-restricting devices shall be computed as required by Section 610.2.

**610.7** On any proposed water piping installation sized using Table 6-5, the following conditions shall be determined:

- (1) Total number of fixture units as determined from Table 6-4, Equivalent Fixture Units, for the fixtures to be installed.
- (2) Developed length of supply pipe from meter to most remote outlet.
- (3) Difference in elevation between the meter or other source of supply and the highest fixture or outlet.
- (4) Pressure in the street main or other source of supply at the locality where the installation is to be made.
- (5) In localities where there is a fluctuation of pressure in the main throughout the day, the water piping system shall be designed on the basis of the minimum pressure available.

**610.8 Size of Meter and Building Supply Pipe Using Table 6-5.** The size of the meter and the building supply pipe shall be determined as follows:

- (1) Determine the available pressure at the water meter or other source of supply;
- (2) Subtract one-half (1/2) pound per square inch pressure (3.4 kPa) for each foot (305 mm) of difference in elevation between such source of supply and highest water supply outlet in the building or on the premises;
- (3) Use the "pressure range" group within which this pressure will fall using Table 6-5;
- (4) Select the "length" column which is equal to or longer than the required length;
- (5) Follow down the column to a fixture unit value equal to or greater than the total number of fixture units required by the installation;
- (6) Having located the proper fixture unit value for the required length, sizes of meter and building supply pipe as found in the two left-hand columns shall be applied.

No building supply pipe shall be less

than three-quarter (3/4) inch (20 mm) in diameter.

**610.9 Size of Branches.** When Table 6-5 is used, the minimum size of each branch shall be determined by the number of fixture units to be served by that branch, the total developed length of the system, and the meter and street service size as per Section 610.8. No branch piping is required to be larger in size than that required by Table 6-5 for the building supply pipe.

**Table 6-7  
Flushometer Fixture Units for Water Sizing Using  
Table 6-5**

**Fixture Category: Water Closet w/ Flushometer Valves**

Number of Flushometer Valves	Individual Fixture Units Assigned in Decreasing Value	Fixture Units Assigned for Water Closets and Similar 10 Unit Fixtures in Accumulative Values
1	40	40
2	30	70
3	20	90
4	15	105
5 or more	10 each	115 plus 10 for each additional fixture in excess of 5

**Fixture Category: Urinals w/ Flushometer Valves**

Number of Flushometer Valves	Individual Fixture Units Assigned in Decreasing Value	Fixture Units Assigned for Urinals and Similar 5 Unit Fixtures in Accumulative Values
1	20	20
2	15	35
3	10	45
4	8	53
5 or more	5 each	58 plus 5 for each additional fixture in excess of 5

**610.10 Sizing for Flushometer Valves.** When using Table 6-5 to size water supply systems serving flushometer valves, the number of flushometer fixture units assigned to every section of pipe, whether branch or main, shall be determined by the number and category of flushometer valves served by that section of pipe, in accordance with Table 6-7. Piping supplying a flushometer valve shall not be less in size than the valve inlet.

Sizing Method  
Example Using TABLE 6-7  
Public Use Fixtures

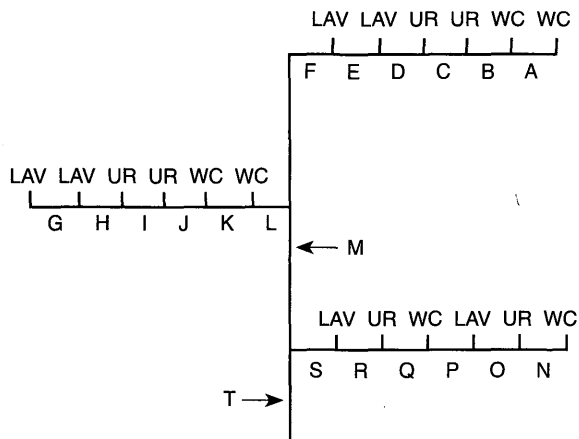

When using Table 6-7 to size water piping, care must be exercised to assign flushometer fixture units based on the number and category of fixtures served. In the example above, fixture units assigned to each section of pipe are computed as follows: Note: Each capital letter refers to the section of pipe above it, unless otherwise shown.

- A: 1 WC = 40 F.U.
- B: 2 WC = 70 F.U.
- C: 2 WC (70) + 1 UR (20) = 90 F.U.
- D: 2 WC (70) + 2 UR (35) = 105 F.U.
- E: 2 WC (70) + 2 UR (35) + 1 LAV (1) = 106 F.U.
- F: 2 WC (70) + 2 UR (35) + 2 LAV (2) = 107 F.U.
- G: 1 LAV = 1 F.U.
- H: 2 LAV = 2 F.U.
- I: 2 LAV (2) + 1 UR (20) = 22 F.U.
- J: 2 LAV (2) + 2 UR (35) = 37 F.U.
- K: 2 LAV (2) + 2 UR (35) + 1 WC (40) = 77 F.U.
- L: 2 LAV (2) + 2 UR (35) + 2 WC (70) = 107 F.U.
- M: 4 WC (105) + 4 UR (53) + 4 LAV (4) = 162 F.U.
- N: 1 WC = 40 F.U.
- O: 1 WC (40) + 1 UR (20) = 60 F.U.
- P: 1 WC (40) + 1 UR (20) + 1 LAV (1) = 61 F.U.
- Q: 2 WC (70) + 1 UR (20) + 1 LAV (1) = 91 F.U.
- R: 2 WC (70) + 2 UR (35) + 1 LAV (1) = 106 F.U.
- S: 2 WC (70) + 2 UR (35) + 2 LAV (2) = 107 F.U.
- T: 6 WC (125) + 6 UR (63) + 6 LAV (6) = 194 F.U.

**610.11 Sizing Systems for Flushometer Tanks.**

The size of branches and mains serving flushometer tanks shall be consistent with the sizing procedures for flush tank water closets.

**610.12 Sizing for Velocity.** Water piping systems shall not exceed the maximum velocities listed in this section or Appendix A.

**610.12.1 Copper Tube Systems.** Maximum velocities in copper and copper alloy tube and fitting systems shall be limited to a maximum of eight (8) feet per second (fps) (2.4 mps) in cold water and five (5) fps in hot water (1.52 mps).

**610.12.2 Tubing Systems Using Copper Alloy Fittings.** Maximum velocities through copper alloy fittings in tubing other than copper shall be limited to a maximum of eight (8) feet per second (fps) (2.4 mps) in cold water and five (5) fps in hot water (1.52 mps).

**610.13 Exceptions.** The provisions of this section relative to size of water piping shall not apply to the following:

- (1) Water supply piping systems designed in accordance with recognized engineering procedures acceptable to the Authority Having Jurisdiction.
- (2) Alteration of or minor additions to existing installations, provided the Authority Having Jurisdiction finds that there will be an adequate supply of water to operate all fixtures.
- (3) Replacement of existing fixtures or appliances.
- (4) Piping which is part of fixture equipment.
- (5) Unusual conditions where, in the judgment of the Authority Having Jurisdiction, an adequate supply of water is provided to operate fixtures and equipment.
- (6) Non-potable water lines as defined in Sections 601.2.2 and 601.2.3.
- (7) The size and material of irrigation water piping installed outside of any building or structure and separated from the potable water supply by means of an approved airgap or backflow prevention device is not regulated by this code. The potable water piping system supplying each such irrigation system shall be adequately sized as required elsewhere in this chapter to deliver the full connected demand of both the domestic use and the irrigation systems.

**611.0 Drinking Water Treatment Units.**

**611.1 Compliance with Standard.** Drinking water treatment units shall meet the requirements of the appropriate standard referenced in Table 14-1.

**611.2 Airgap Discharge.** Discharge from all drinking water treatment units shall enter the



drainage system through an airgap or an airgap device which meets the requirements of the appropriate standards referenced in Table 14-1.

**611.3 Connection Tubing.** The tubing to and from drinking water treatment units shall be of a size and material as recommended by the manufacturer. The tubing shall comply with the requirements of the appropriate standards referenced in Table 14-1.

**611.4 Sizing of Residential Softeners.** Residential-use water softeners shall be sized per Table 6-8.

**TABLE 6-8**  
**Sizing of Residential Water Softeners**

Required Size of Softener Connection	Number of Bathroom Groups Served <sup>1</sup>
3/4 in.	up to 2 <sup>2</sup>
1 in.	up to 4 <sup>3</sup>

<sup>1</sup> Installation of a kitchen sink and dishwasher, laundry tray, and automatic clothes washer permitted without additional size increase.

<sup>2</sup> An additional water closet and lavatory permitted.

<sup>3</sup> Over four bathroom groups, the softener size shall be engineered for the specific installation.

*See also Appendix A, Recommended Rules for Sizing the Water Supply System, and Appendix L, Alternate Plumbing Systems, for alternate methods of sizing water supply systems.*

# CHAPTER 7

## SANITARY DRAINAGE

### Part I – Drainage Systems

#### 701.0 Materials.

**701.1** Drainage piping shall be cast iron, galvanized steel, galvanized wrought iron, lead, copper, brass, Schedule 40 ABS DWV, Schedule 40 PVC DWV, extra strength vitrified clay pipe, or other approved materials having a smooth and uniform bore, except that:

**701.1.1** No galvanized wrought iron or galvanized steel pipe shall be used underground and shall be kept at least six (6) inches (152 mm) above ground.

**701.1.2** ABS and PVC DWV piping installations shall be installed in accordance with IS 5, IS 9, and Chapter 15 "Firestop Protection." Except for individual single-family dwelling units, materials exposed within ducts or plenums shall have a flame-spread index of not more than 25 and a smoke-developed index of not more than 50, when tested in accordance with the Test for Surface - Burning Characteristics of the Building Materials. (See the Building Code standards based on ASTM E-84 and ANSI/UL 723.)

**701.1.3** No vitrified clay pipe or fittings shall be used above ground or where pressurized by a pump or ejector. They shall be kept at least twelve (12) inches (305 mm) below ground.

**701.1.4** Copper tube for drainage and vent piping shall have a weight of not less than that of copper drainage tube type DWV.

**701.2** Drainage fittings shall be of cast iron, malleable iron, lead, brass, copper, ABS, PVC, vitrified clay, or other approved materials having a smooth interior waterway of the same diameter as the piping served, and all such fittings shall be compatible with the type of pipe used.

**701.2.1** Fittings on screwed pipe shall be of the recessed drainage type. Burred ends shall be reamed to the full bore of the pipe.

**701.2.2** The threads of drainage fittings shall be tapped so as to allow one-quarter (1/4) inch per foot (20.9 mm/m) grade.

**701.2.3** Fittings used for drainage shall be of the drainage type, have a smooth interior waterway, and be constructed so as to allow one fourth (1/4) inch per foot (20.9 mm/m) grade.

#### 701.3 Lead.

See Table 14-1. Sheet lead shall be not less than the following:

For safe pans – not less than four (4) pounds per square foot (19.5 kg/m<sup>2</sup>) or 1/16 inch (1.6 mm) thick.

For flashings or vent terminals – not less than three (3) pounds per square foot (15 kg/m<sup>2</sup>) or 1.2 mm thick.

Lead bends and lead traps shall not be less than one-eighth (1/8) inch (3.2 mm) wall thickness.

**TABLE 7-1  
Caulking Ferrules**

Pipe Size (inches)	Inside Diameter (inches)	Length (inches)	Minimum Weight Each	
			Lb.	oz.
2	2-1/4	4-1/2	1	0
3	3-1/4	4-1/2	1	12
4	4-1/4	4-1/2	2	8

**Caulking Ferrules (Metric)**

Pipe Size (mm)	Inside Diameter (mm)	Length (mm)	Minimum Weight Each (kg)	
			Lb.	oz.
50	57	114	0.454	
80	83	114	0.790	
100	108	114	1.132	

**TABLE 7-2  
Soldering Bushings**

Pipe Size (inches)	Minimum Weight Each		Pipe Size (inches)	Minimum Weight Each	
	Lb.	oz.		Lb.	oz.
1-1/4	0	6	2-1/2	1	6
1-1/2	0	8	3	2	0
2	0	14	4	3	8

**Soldering Bushings (Metric)**

Pipe Size (mm)	Minimum Weight Each (kg)		Pipe Size (mm)	Minimum Weight Each (kg)	
	Lb.	oz.		Lb.	oz.
32	0.168		65	0.622	
40	0.224		80	0.908	
50	0.392		100	1.586	

**TABLE 7-3**  
**Drainage Fixture Unit Values (DFU)**

Inch	mm
1-1/4	32
1-1/2	40
2	50
2-1/2	65
3	80

Plumbing Appliance, Appurtenance, or Fixture	Min. Size Trap and Trap Arm <sup>7</sup>	Private	Public	Assembly <sup>8</sup>
Bathtub or Combination Bath/Shower.....	1-1/2"	2.0	2.0	
Bidet.....	1-1/4"	1.0		
Bidet.....	1-1/2"	2.0		
Clothes Washer, domestic, standpipe <sup>5</sup> .....	2"	3.0	3.0	3.0
Dental Unit, cuspidor.....	1-1/4"		1.0	1.0
Dishwasher, domestic, with independent drain.....	1-1/2" <sup>2</sup>	2.0	2.0	2.0
Drinking Fountain or Watercooler (per head).....	1-1/4"	0.5	0.5	1.0
Food-waste-grinder, commercial.....	2"		3.0	3.0
Floor Drain, emergency.....	2"		0.0	0.0
Floor Drain (for additional sizes see Section 702).....	2"	2.0	2.0	2.0
Shower single head trap.....	2"	2.0	2.0	2.0
Multi-head, each additional.....	2"	1.0	1.0	1.0
Lavatory, single.....	1-1/4"	1.0	1.0	1.0
Lavatory in sets of two or three.....	1-1/2"	2.0	2.0	2.0
Washfountain.....	1-1/2"		2.0	2.0
Washfountain.....	2"		3.0	3.0
Mobile Home, trap.....	3"	12.0		
Receptor, indirect waste <sup>1,3</sup> .....	1-1/2"			See footnote <sup>1,3</sup>
Receptor, indirect waste <sup>1,4</sup> .....	2"			See footnote <sup>1,4</sup>
Receptor, indirect waste <sup>1</sup> .....	3"			See footnote <sup>1</sup>
<b>Sinks</b>				
Bar.....	1-1/2"	1.0		
Bar.....	1-1/2" <sup>2</sup>		2.0	2.0
Clinical.....	3"		6.0	6.0
Commercial with food waste.....	1-1/2" <sup>2</sup>		3.0	3.0
Special Purpose.....	1-1/2"	2.0	3.0	3.0
Special Purpose.....	2"	3.0	4.0	4.0
Special Purpose.....	3"		6.0	6.0
Kitchen, domestic.....	1-1/2" <sup>2</sup>	2.0	2.0	
(with or without food-waste-grinder and/or dishwasher)				
Laundry.....	1-1/2"	2.0	2.0	2.0
(with or without discharge from a clothes washer)				
Service or Mop Basin.....	2"		3.0	3.0
Service or Mop Basin.....	3"		3.0	3.0
Service, flushing rim.....	3"		6.0	6.0
Wash, each set of faucets.....			2.0	2.0
Urinal, integral trap 1.0 GPF <sup>2</sup> .....	2"	2.0	2.0	5.0
Urinal, integral trap greater than 1.0 GPF.....	2"	2.0	2.0	6.0
Urinal, exposed trap.....	1-1/2" <sup>2</sup>	2.0	2.0	5.0
Water Closet, 1.6 GPF Gravity Tank <sup>6</sup> .....	3"	3.0	4.0	6.0
Water Closet, 1.6 GPF Flushometer Tank <sup>6</sup> .....	3"	3.0	4.0	6.0
Water Closet, 1.6 GPF Flushometer Valve <sup>6</sup> .....	3"	3.0	4.0	6.0
Water Closet, greater than 1.6 GPF Gravity Tank <sup>6</sup> .....	3"	4.0	6.0	8.0
Water Closet, greater than 1.6 GPF Flushometer Valve <sup>6</sup> .....	3"	4.0	6.0	8.0

<sup>1</sup> Indirect waste receptors shall be sized based on the total drainage capacity of the fixtures that drain therein to, in accordance with Table 7-4.

<sup>2</sup> Provide a 2" (51 mm) minimum drain.

<sup>3</sup> For refrigerators, coffee urns, water stations, and similar low demands.

<sup>4</sup> For commercial sinks, dishwashers, and similar moderate or heavy demands.

<sup>5</sup> Buildings having a clothes washing area with clothes washers in a battery of three (3) or more clothes washers shall be rated at six (6) fixture units each for purposes of sizing common horizontal and vertical drainage piping.

<sup>6</sup> Water closets shall be computed as six (6) fixture units when determining septic tank sizes based on Appendix K of this code.

<sup>7</sup> Trap sizes shall not be increased to the point where the fixture discharge may be inadequate to maintain their self-scouring properties.

<sup>8</sup> Assembly [Public Use (See Table 4-1)].

**701.4 Ferrules and Bushings**

**701.4.1** Caulking ferrules shall be manufactured from bronze or copper and shall be in accordance with Table 7-1.

**701.4.2** Soldering bushings shall be of bronze or copper in accordance with Table 7-2.

**702.0 Fixture Unit Equivalents.**

The unit equivalent of plumbing fixtures shown in Table 7-3 shall be based on the size of the trap required, and the unit equivalent of fixtures and devices not shown in Table 7-3 shall be based on the rated discharge capacity in gpm (gallons per minute) (liters per second) in accordance with Table 7-4.

Maximum trap loadings for sizes up to four (4) inches (102 mm) are as follows:

1-1/4 in.	(32 mm)	—	1 unit
1-1/2 in.	(40 mm)	—	3 units
2 in.	(50 mm)	—	4 units
3 in.	(80 mm)	—	6 units
4 in.	(100 mm)	—	8 units

**Exception:** On self-service laundries.

**703.0 Size of Drainage Piping.**

**703.1** The minimum sizes of vertical and/or horizontal drainage piping shall be determined from the total of all fixture units connected thereto, and additionally, in the case of vertical drainage pipes, in accordance with their length.

**703.2** Table 7-5 shows the maximum number of fixture units allowed on any vertical or horizontal drainage pipe, building drain or building sewer of a given size; the maximum number of fixture units allowed on any branch interval of a given size; and the maximum length (in feet and meters) of any vertical drainage pipe of a given size.

**TABLE 7-4**  
**Discharge Capacity in Gallons per Minute**  
**(Liters per Second)**  
**For Intermittent Flow Only**

GPM	(L/sec)		
Up to 7-1/2	(Up to 0.47)	Equals	1 Unit
8 to 15	(0.50 to 0.95)	Equals	2 Units
16 to 30	(1.00 to 1.89)	Equals	4 Units
31 to 50	(1.95 to 3.15)	Equals	6 Units

Discharge capacity for over 50 gallons per minute (3.15 L/sec.) shall be determined by the Authority Having Jurisdiction.

For a continuous flow into a drainage system, such as from a pump, sump ejector, air conditioning equipment, or similar device, two (2) fixture units shall be allowed for each gallon per minute (0.06 L/sec.) of flow.

**703.3** For alternate method of sizing drainage piping, see Appendix L.

**704.0 Fixture Connections (Drainage).**

**704.1** Drainage piping shall be provided with approved inlet fittings for fixture connections, correctly located according to the size and type of fixture proposed to be connected.

**704.2** Two fixtures set back-to-back, or side-by-side, within the distance allowed between a trap and its vent may be served by a single vertical drainage pipe provided that each fixture wastes separately into an approved double-fixture fitting having inlet openings at the same level.

**704.3** Pot sinks, scullery sinks, dishwashing sinks, silverware sinks, commercial dishwashing machines, silverware-washing machines, and other similar fixtures shall be connected directly to the drainage system. A floor drain shall be provided adjacent to the fixture, and the fixture shall be connected on the sewer side of the floor drain trap, provided that no other drainage line is connected between the floor drain waste connection and the fixture drain. The fixture and floor drain shall be trapped and vented as required by this code.

**704.4 Closet Rings (Closet Flanges).**

**704.4.1** Closet rings (closet flanges) for water closets or similar fixtures shall be of an approved type and shall be bronze, copper, hard lead, cast iron, galvanized malleable iron, ABS, PVC, or other approved materials. Each such closet ring (closet flange) shall be approximately seven (7) inches (175 mm) in diameter and, when installed, shall, together with the soil pipe, present a one and one-half (1-1/2) inch (38 mm) wide flange or face to receive the fixture gasket or closet seal.

**704.4.2** Caulked-on closet rings (closet flanges) shall be not less than one-fourth (1/4) inch (6.4 mm) thick and not less than two (2) inches (51 mm) in overall depth.

**704.4.3** Closet rings (closet flanges) shall be burned or soldered to lead bends or stubs, shall be caulked to cast iron soil pipe, shall be solvent cemented to ABS and PVC, and shall be screwed or fastened in an approved manner to other materials.

**TABLE 7-5**  
Maximum Unit Loading and Maximum Length of Drainage and Vent Piping

Size of Pipe, inches (mm)	1-1/4 (32)	1-1/2 (40)	2 (50)	2-1/2 (65)	3 (80)	4 (100)	5 (125)	6 (150)	8 (200)	10 (250)	12 (300)
<b>Maximum Units</b>											
Drainage Piping <sup>1</sup>											
Vertical	1	2 <sup>2</sup>	16 <sup>3</sup>	32 <sup>3</sup>	48 <sup>4</sup>	256	600	1380	3600	5600	8400
Horizontal	1	1	8 <sup>3</sup>	14 <sup>3</sup>	35 <sup>4</sup>	216 <sup>5</sup>	428 <sup>5</sup>	720 <sup>5</sup>	2640 <sup>5</sup>	4680 <sup>5</sup>	8200 <sup>5</sup>
<b>Maximum Length</b>											
Drainage Piping											
Vertical, feet (m)	45 (14)	65 (20)	85 (26)	148 (45)	212 (65)	300 (91)	390 (119)	510 (155)	750 (228)		
Horizontal (Unlimited)											
<b>Vent Piping (See note)</b>											
Horizontal and Vertical											
Maximum Units	1	8 <sup>3</sup>	24	48	84	256	600	1380	3600		
Maximum Lengths, feet (m)	45 (14)	60 (18)	120 (37)	180 (55)	212 (65)	300 (91)	390 (119)	510 (155)	750 (228)		

<sup>1</sup> Excluding trap arm.

<sup>2</sup> Except sinks, urinals and dishwashers.

<sup>3</sup> Except six-unit traps or water closets.

<sup>4</sup> Only four (4) water closets or six-unit traps allowed on any vertical pipe or stack; and not to exceed three (3) water closets or six-unit traps on any horizontal branch or drain.

<sup>5</sup> Based on one-fourth (1/4) inch per foot (20.9 mm/m) slope. For one-eighth (1/8) inch per foot (10.4 mm/m) slope, multiply horizontal fixture units by a factor of 0.8.

**Note:** The diameter of an individual vent shall not be less than one and one-fourth (1-1/4) inches (31.8 mm) nor less than one-half (1/2) the diameter of the drain to which it is connected. Fixture unit load values for drainage and vent piping shall be computed from Tables 7-3 and 7-4. Not to exceed one-third (1/3) of the total permitted length of any vent may be installed in a horizontal position. When vents are increased one (1) pipe size for their entire length, the maximum length limitations specified in this table do not apply.

**704.4.4** All such closet rings (closet flanges) shall be adequately designed and secured to support fixtures connected thereto.

**704.4.5** Closet screws, bolts, washers, and similar fasteners shall be of brass, copper, or other listed, equally corrosion-resistant materials. All such screws and bolts shall be of adequate size and number to properly support the fixture installed.

## 705.0 Joints and Connections.

### 705.1 Types of Joints.

**705.1.1 Caulked Joints.** Caulked joints for cast iron bell-and-spigot soil pipe and other similar joints shall be firmly packed with oakum or hemp and filled with molten lead to a depth of not less than one (1) inch (25.4 mm). The lead shall be caulked thoroughly at the inside and outside edges of the joint. After caulking, the finished joint shall not extend more than one-eighth (1/8) inch (3.2 mm) below the rim of the hub. No paint, varnish, or other coatings shall be permitted on the joining material until after the joint has been tested and approved. Caulked

joints in cast iron bell-and-spigot water piping shall be made with nontoxic materials.

**705.1.2 Cement Mortar Joints.** Except for repairs and connections to existing lines constructed with such joints, cement mortar joints shall be prohibited on building sewers.

**705.1.3 Burned Lead Joints.** Burned (welded) lead joints shall be lapped, and the lead shall be fused together to form a uniform weld at least as thick as the lead being joined.

**705.1.4 Asbestos Cement Sewer Pipe Joints.** Joints in asbestos cement pipe shall be a sleeve coupling of the same composition as the pipe or of other approved materials, and sealed with rubber rings or joined by an approved type compression coupling. Joints between asbestos cement pipe and other approved pipe shall be made by means of an approved adapter coupling.

**705.1.5 Packing Additives Prohibited.** The addition of leak-sealing additives to joint packing shall be prohibited.

**705.1.6 Molded Rubber Coupling Joints.** When pipe is joined by means of molded rubber coupling joints, such joints shall conform to

approved standards and shall not be considered as slip joints. When required, appropriate rubber bushings shall be used to allow for any difference in piping material diameters.

**705.1.7 Elastomeric Gasketed and Rubber-Ring Joints.** Elastomeric gasketed and rubber-ring joints shall comply with the applicable Installation Standard listed in Appendix I.

**705.1.8 Shielded Coupling Joints.** When piping systems are joined by means of shielded couplings, such couplings shall conform to approved standards and shall not be considered as slip joints.

**705.1.9 Hubless Cast-Iron Pipe Joints.** Joints for hubless cast iron soil pipe and fittings shall conform to appropriate Installation Standards listed in Appendix I and shall not be considered as slip joints.

## 705.2 Use of Joints.

**705.2.1 Clay and Sewer Pipe.** Joints in vitrified clay pipe or between such pipe and metal pipe shall be made as provided in Section 316.1.5, 705.1.2, 705.1.6, or 705.1.8.

**705.2.2 Cast-Iron Pipe.** Joints in cast-iron pipe shall be made as provided in Section 316.1.1, 316.1.5, 606.1.2, 705.1.1, 705.1.8 or 705.1.9.

**705.2.3 Screw Pipe to Cast Iron.** Joints between wrought iron, steel, brass, or copper pipe and cast iron pipe shall be either caulked or threaded joints made as provided in Section 316.1.1 or 705.1.1, or shall be made with approved adapter fittings.

**705.2.4 Lead to Cast Iron, Wrought Iron, or Steel.** Joints between lead and cast iron, wrought iron, or steel pipe shall be made by means of wiped joints to a caulking ferrule, soldering nipple, or bushing as provided in Section 316.1.2.

## 705.3 Special Joints.

**705.3.1 Slip Joints.** In fixture drains and traps, slip joints of approved materials may be used in accordance with their approvals.

**705.3.2 Expansion Joints.** Expansion joints shall be accessible, except when in vent piping or drainage stacks, and may be used where necessary to provide for expansion and contraction of the pipes.

**705.3.3 Ground Joint, Flared, or Ferrule Connections.** Brass or copper ground joint, flared, or ferrule type connections which allow adjustment of tubing, but provide a rigid joint when made up, shall not be considered as slip joints.

## 706.0 Changes in Direction of Drainage Flow.

**706.1** Changes in direction of drainage piping shall be made by the appropriate use of approved fittings and shall be of the angles presented by a one-sixteenth (1/16) bend, one-eighth (1/8) bend, or one-sixth (1/6) bend, or other approved fittings of equivalent sweep.

**706.2** Horizontal drainage lines, connecting with a vertical stack, shall enter through forty-five (45) degree (0.79 rad) wye branches, sixty (60) degree (1.05 rad) wye branches, combination wye and 1/8 bend branches, sanitary tee or sanitary tapped tee branches, or other approved fittings of equivalent sweep. No fitting having more than one (1) inlet at the same level shall be used unless such fitting is constructed so that the discharge from one (1) inlet cannot readily enter any other inlet. Double sanitary tees may be used when the barrel of the fitting is at least two (2) pipe sizes larger than the largest inlet, (pipe sizes recognized for this purpose are 2 in., 2-1/2 in., 3 in., 3-1/2 in., 4 in., 4-1/2 in., 5 in., 6 in., etc.) (50, 65, 80, 90, 100, 115, 125, 150 mm, etc.).

**706.3** Horizontal drainage lines connecting with other horizontal drainage lines shall enter through forty-five (45) degree (0.79 rad) wye branches, combination wye and one-eighth (1/8) bend branches, or other approved fittings of equivalent sweep.

**706.4** Vertical drainage lines connecting with horizontal drainage lines shall enter through forty-five (45) degree (0.79 rad) wye branches, combination wye and one-eighth (1/8) bend branches, or other approved fittings of equivalent sweep. Sixty (60) degree (1.05 rad) branches or offsets may be used only when installed in a true vertical position.

## 707.0 Cleanouts.

**707.1** Each cleanout fitting for cast iron pipe shall consist of a cast iron or brass body and an approved plug. Each cleanout for galvanized wrought iron, galvanized steel, copper, or brass pipe shall consist of a brass plug as specified in Table 7-6, or a standard weight brass cap, or an approved ABS or PVC plastic plug. Plugs shall have raised square heads or approved countersunk rectangular slots.

**707.2** Each cleanout fitting and each cleanout plug or cap shall be of an approved type. Materials used for cleanouts shall conform to approved standards acceptable to the Authority Having Jurisdiction.

**707.3** Cleanouts shall be designed to be gas and watertight.

**707.4** Each horizontal drainage pipe shall be provided with a cleanout at its upper terminal and

each run of piping, which is more than one hundred (100) feet (30,480 mm) in total developed length, shall be provided with a cleanout for each one hundred (100) feet (30,480 mm), or fraction thereof, in length of such piping.

**Exceptions:**

- (1) Cleanouts may be omitted on a horizontal drain line less than five (5) feet (1524 mm) in length unless such line is serving sinks or urinals.
- (2) Cleanouts may be omitted on any horizontal drainage pipe installed on a slope of seventy-two (72) degrees (1.26 rad) or less from the vertical angle (angle of one-fifth (1/5) bend).
- (3) Excepting the building drain and its horizontal branches, a cleanout shall not be required on any pipe or piping which is above the floor level of the lowest floor of the building.
- (4) An approved type of two-way cleanout fitting, installed inside the building wall near the connection between the building drain and building sewer or installed outside of a building at the lower end of a building drain and extended to grade, may be substituted for an upper terminal cleanout.

**707.5** An additional cleanout shall be provided in a drainage line for each aggregate horizontal change of direction exceeding one hundred and thirty-five (135) degrees (2.36 rad).

**707.6** Each cleanout shall be installed so that it opens to allow cleaning in the direction of flow of the soil or waste or at right angles thereto and, except in the case of wye branch and end-of-line cleanouts, shall be installed vertically above the flow line of the pipe.

**707.7** Each cleanout extension shall be considered as drainage piping and each ninety (90) degree (1.6 rad) cleanout extension shall be extended from a wye-type fitting or other approved fitting of equivalent sweep.

**707.8** Each cleanout for an interceptor shall be outside of such interceptor.

**707.9** Each cleanout, unless installed under an approved cover plate, shall be above grade, readily accessible, and so located as to serve the purpose for which it is intended. Cleanouts located under cover plates shall be so installed as to provide the clearances and accessibility required by this section.

**707.10** Each cleanout in piping two (2) inches (50 mm) or less in size shall be so installed that there is a clearance of not less than twelve (12) inches (305 mm) in front of the cleanout. Cleanouts in piping larger than two (2) inches (50 mm) shall have a

clearance of not less than eighteen (18) inches (457 mm) in front of the cleanout. Cleanouts in underfloor piping shall be extended to or above the finished floor or shall be extended outside the building when there is less than eighteen (18) inches (457 mm) vertical overall, allowing for obstructions such as ducts, beams, and piping and thirty (30) inches (762 mm) horizontal clearance from the means of access to such cleanout. No underfloor cleanout shall be located more than twenty (20) feet (6096 mm) from an access door, trap door, or crawl hole.

**707.11** Cleanout fittings shall be not less in size than those given in Table 7-6.

**707.12** Cleanouts shall be provided for pressure drainage systems as classified under Section 710.7.

**Table 7-6  
Cleanouts**

Size of Pipe (inches)	Size of Cleanout (inches)	Threads (per inches)
1-1/2	1-1/2	11-1/2
2	1-1/2	11-1/2
2-1/2	2-1/2	8
3	2-1/2	8
4 & larger	3-1/2	8

**TABLE 7-6  
Cleanouts (Metric)**

Size of Pipe (mm)	Size of Cleanout (mm)	Threads (per 25.4 mm)
40	38	11-1/2
50	38	11-1/2
65	64	8
80	64	8
100 & larger	89	8

**707.13** Countersunk cleanout plugs shall be installed where raised heads may cause a hazard.

**707.14** When a hubless blind plug is used for a required cleanout, the complete coupling and plug shall be accessible for removal or replacement.

**708.0 Grade of Horizontal Drainage Piping.**

Horizontal drainage piping shall be run in practical alignment and a uniform slope of not less than one-fourth (1/4) inch per foot (20.9 mm/m) or two (2) percent toward the point of disposal provided that, where it is impractical due to the depth of the street sewer or to the structural features or to the arrangement of any building or structure to obtain a

slope of one-fourth (1/4) of an inch per foot (20.9 mm/m) or two (2) percent, any such pipe or piping four (4) inches (100 mm) or larger in diameter may have a slope of not less than one-eighth (1/8) of an inch per foot (10.5 mm/m) or one (1) percent, when first approved by the Authority Having Jurisdiction.

#### **709.0 Gravity Drainage Required.**

Wherever practicable, all plumbing fixtures shall be drained to the public sewer or private sewage disposal system by gravity.

#### **710.0 Drainage of Fixtures Located Below the Next Upstream Manhole or Below the Main Sewer Level.**

**710.1** Drainage piping serving fixtures which have flood-level rims located below the elevation of the next upstream manhole cover of the public or private sewer serving such drainage piping shall be protected from backflow of sewage by installing an approved type of backwater valve. Fixtures above such elevation shall not discharge through the backwater valve.

**710.2** Drainage piping serving fixtures that are located below the crown level of the main sewer shall discharge into an approved watertight sump or receiving tank, so located as to receive the sewage or wastes by gravity. From such sump or receiving tank, the sewage or other liquid wastes shall be lifted and discharged into the building drain or building sewer by approved ejectors, pumps, or other equally efficient approved mechanical device.

**710.3** A sewage ejector or sewage pump receiving the discharge of water closets or urinals:

**710.3.1** Shall have a minimum discharge capacity of twenty (20) gallons (75.7 liters) per minute.

**710.3.2** In single dwelling units, the ejector or pump shall be capable of passing a one and one-half (1-1/2) inch (38 mm) diameter solid ball, and the discharge piping of each ejector or pump shall have a backwater valve and gate valve, and be a minimum of two (2) inches (51 mm) in diameter.

**710.3.3** In other than single-dwelling units, the ejector or pump shall be capable of passing a two (2) inch (51 mm) diameter solid ball, and the discharge piping of each ejector or pump shall have a backwater valve and gate valve, and be a minimum of three (3) inches (80 mm) in diameter.

**710.4** The discharge line from such ejector, pump, or other mechanical device shall be provided with an accessible backwater or swing check valve and gate or ball valve. If the gravity drainage line to which such discharge line connects is horizontal, the

method of connection shall be from the top through a wye branch fitting. The gate or ball valve shall be located on the discharge side of the backwater or check valve.

Gate or ball valves, when used on drainage work, shall be fullway type with working parts of corrosion-resistant metal. Sizes four (4) inches (100mm) or more in diameter shall have cast-iron bodies, and sizes less than four (4) inches (100 mm), cast iron or brass bodies.

**710.5** Building drains or building sewers receiving discharge from any pump or ejector shall be adequately sized to prevent overloading. Two (2) fixture units shall be allowed for each gallon per minute (0.06 L/s) of flow.

**710.6** Backwater valves, gate valves, fullway ball valves, unions, motors, compressors, air tanks, and other mechanical devices required by this section shall be located where they will be accessible for inspection and repair at all times and, unless continuously exposed, shall be enclosed in a masonry pit fitted with an adequately sized removable cover.

Backwater valves shall have bodies of cast iron, plastic, brass, or other approved materials; noncorrosive bearings, seats, and self-aligning discs; and shall be constructed so as to insure a positive mechanical seal. Such backwater valves shall remain sufficiently open during periods of low flows to avoid screening of solids and shall not restrict capacities or cause excessive turbulence during peak loads. Unless otherwise listed, valve access covers shall be bolted type with gasket, and each valve shall bear the manufacturer's name cast into body and cover.

**710.7** The drainage and venting systems in connection with fixtures, sumps, receiving tanks, and mechanical waste-lifting devices, shall be installed under the same requirements as provided for in this code for gravity systems.

**710.8** Sumps and receiving tanks shall be watertight and shall be constructed of concrete, metal, or other approved materials. If constructed of poured concrete, the walls and bottom shall be adequately reinforced and designed to recognized acceptable standards. Metal sumps or tanks shall be of such thickness as to serve their intended purpose and shall be treated internally and externally to resist corrosion.

**710.9** All such sumps and receiving tanks shall be automatically discharged and, when in any "public use" occupancy, shall be provided with dual pumps or ejectors arranged to function alternately in normal use and independently in case of overload or mechanical failure. The pumps shall have an audio and visual alarm, readily accessible, that signals



pump failure or an overload condition. The lowest inlet shall have a minimum clearance of two (2) inches (51 mm) from the high-water or "starting" level of the sump.

**710.10** Sumps and receiving tanks shall be provided with substantial covers having a bolt and gasket type manhole or equivalent opening to permit access for inspection, repairs, and cleaning. The top shall be provided with a vent pipe which shall extend separately through the roof or, when permitted, may be combined with other vent pipes. Such vent shall be large enough to maintain atmospheric pressure within the sump under all normal operating conditions and, in no case, shall be less in size than that required by Table 7-5 for the number and type of fixtures discharging into the sump, nor less than one and one-half (1-1/2) inches (40 mm) in diameter. When the foregoing requirements are met and the vent, after leaving the sump, is combined with vents from fixtures discharging into the sump, the size of the combined vent need not exceed that required for the total number of fixtures discharging into the sump. No vent from an air-operating sewage ejector shall combine with other vents.

**710.11** Air tanks shall be so proportioned as to be of equal cubical capacity to the ejectors connected therewith in which there shall be maintained an air pressure of not less than two (2) pounds for each foot (3 kg for each m) of height the sewage is to be raised. No water operated ejectors shall be permitted.

**710.12** When subsoil drainage systems are installed, such systems shall be discharged into an approved sump or receiving tank and shall be discharged in a manner satisfactory to the Authority Having Jurisdiction.

**710.13 Grinder Pump Ejector.** With the approval of the Authority Having Jurisdiction, a grinder pump may be used.

**710.14 Macerating Toilet Systems.** Listed macerating toilet systems shall be permitted as an alternate to a sewage pump system for single bathrooms for private use when approved by the Authority Having Jurisdiction.

**710.14.1 Sumps.** The sump shall be water- and gastight.

**710.14.2 Discharge Piping.** The discharge piping shall be sized per manufacturer's instructions and shall be not less than 3/4 in. (20 mm) in diameter. The developed length of the discharge piping shall not exceed manufacturer's recommendations. A check valve and fullway-type shutoff valve shall be located within the discharge line or internally within the device.

**710.14.3 Venting.** The plumbing fixtures which

discharge into the macerating device shall be vented per this code. The sump shall be vented per manufacturer's instructions and such vent shall be permitted to connect to the fixture venting.

#### **711.0 Suds Relief.**

Drainage connections shall not be made into a drainage piping system within eight (8) feet (2438 mm) of any vertical to horizontal change of direction of a stack containing suds-producing fixtures. Bathtubs, laundries, washing machine standpipes, kitchen sinks, and dishwashers shall be considered suds-producing fixtures. Where parallel vent stacks are required, they shall connect to the drainage stack at a point eight (8) feet (2438 mm) above the lowest point of the drainage stack.

#### **Exceptions:**

- (1) Single-family residences.
- (2) Stacks receiving the discharge from less than three (3) stories of plumbing fixtures.

#### **712.0 Testing.**

**712.1 Media.** The piping of the plumbing, drainage, and venting systems shall be tested with water or air except that plastic pipe shall not be tested with air. The Authority Having Jurisdiction may require the removal of any cleanouts, etc., to ascertain whether the pressure has reached all parts of the system. After the plumbing fixtures have been set and their traps filled with water, they shall be submitted to a final test.

**712.2 Water Test.** The water test shall be applied to the drainage and vent systems either in its entirety or in sections. If the test is applied to the entire system, all openings in the piping shall be tightly closed, except the highest opening, and the system filled with water to point of overflow. If the system is tested in sections, each opening shall be tightly plugged except the highest opening of the section under test, and each section shall be filled with water, but no section shall be tested with less than a ten (10) foot (3048 mm) head of water. In testing successive sections, at least the upper ten (10) feet (3048 mm) of the next preceding section shall be tested, so that no joint or pipe in the building (except the uppermost ten (10) feet (3048 mm) of the system) shall have been submitted to a test of less than a ten (10) foot (3048 mm) head of water. The water shall be kept in the system, or in the portion under test, for at least fifteen (15) minutes before inspection starts. The system shall then be tight at all points.

**712.3 Air Test.** The air test shall be made by attaching an air compressor testing apparatus to any

suitable opening and, after closing all other inlets and outlets to the system, forcing air into the system until there is a uniform gauge pressure of five (5) pounds per square inch (34.5 kPa) or sufficient to balance a column of mercury ten (10) inches (254 mm) in height. The pressure shall be held without introduction of additional air for a period of at least fifteen (15) minutes.

## Part II – Building Sewers.

### 713.0 Sewer Required.

**713.1** Every building in which plumbing fixtures are installed and every premises having drainage piping thereon, shall have a connection to a public or private sewer, except as provided in Sections 101.4.1.3, 713.2 and 713.4.

**713.2** When no public sewer intended to serve any lot or premises is available in any thoroughfare or right of way abutting such lot or premises, drainage piping from any building or works shall be connected to an approved private sewage disposal system.

**713.3** Within the limits prescribed by Section 713.4 hereof, the rearrangement or subdivision into smaller parcels of a lot which abuts and is served by a public sewer shall not be deemed cause to permit the construction of a private sewage disposal system, and all plumbing or drainage systems on any such smaller parcel or parcels shall connect to the public sewer.

**713.4** The public sewer may be considered as not being available when such public sewer or any building or any exterior drainage facility connected thereto is located more than two hundred (200) feet (60.8 m) from any proposed building or exterior drainage facility on any lot or premises which abuts and is served by such public sewer.

**713.5** No permit shall be issued for the installation, alteration, or repair of any private sewage disposal system, or part thereof, on any lot for which a connection with a public sewer is available.

**713.6** On every lot or premises hereafter connected to a public sewer, all plumbing and drainage systems or parts thereof on such lot or premises shall be connected with such public sewer.

**Exception:** Single-family dwellings and buildings or structures accessory thereto, existing and connected to an approved private sewage disposal system prior to the time of connecting the premises to public sewer may, when no hazard, nuisance, or insanitary condition is evidenced and written permission has been obtained from the Authority Having Jurisdiction, remain connected to such properly

maintained private sewage disposal system when there is insufficient grade or fail to permit drainage to the sewer by gravity.

### 714.0 Damage to Public Sewer or Private Sewage Disposal System.

**714.1** It shall be unlawful for any person to deposit, by any means whatsoever, into any plumbing fixture, floor drain, interceptor, sump, receptor, or device which is connected to any drainage system, public sewer, private sewer, septic tank, or cesspool, any ashes, cinders, solids, rags, flammable, poisonous, or explosive liquids or gases, oils, grease, and any other thing whatsoever which would or could cause damage to the public sewer, private sewer, or private sewage disposal system.

**714.2** No rain, surface, or subsurface water shall be connected to or discharged into any drainage system, unless first approved by the Authority Having Jurisdiction.

**714.3** No cesspool, septic tank, seepage pit, or drainfield shall be connected to any public sewer or to any building sewer leading to such public sewer.

**714.4** No commercial food-waste grinder shall be connected to a private sewage disposal system unless permission has first been obtained from the Authority Having Jurisdiction.

**714.5** An approved type watertight sewage or waste water holding tank, the contents of which, due to their character, must be periodically removed and disposed of at some approved off-site location, shall be installed only when required by the Authority Having Jurisdiction or the Health Officer to prevent anticipated surface or subsurface contamination or pollution, damage to the public sewer, or other hazardous or nuisance condition.

### 715.0 Building Sewer Materials.

**715.1** The building sewer, beginning two (2) feet (610 mm) from any building or structure, shall be of such materials as may be approved by the Authority Having Jurisdiction under the approval procedures set forth in Chapter 3 of this code.

**715.2** Joining methods and materials shall be as prescribed in this code.

**715.3** – (See TIA on page vii).

### 716.0 Markings.

All pipe, brick, block, prefabricated septic tanks, prefabricated septic tank or seepage pit covers, or other parts or appurtenances incidental to the installation of building sewers or private sewage

disposal systems shall conform to the approval requirements of Chapter 3 of this code and shall be marked and identified in a manner satisfactory to the Authority Having Jurisdiction.

#### **717.0 Size of Building Sewers.**

The minimum size of any building sewer shall be determined on the basis of the total number of fixture units drained by such sewer, in accordance with Table 7-8. No building sewer shall be smaller than the building drain.

For alternate methods of sizing building sewers, see Appendix L.

#### **718.0 Grade, Support, and Protection of Building Sewers.**

**718.1** Building sewers shall be run in practical alignment and at a uniform slope of not less than one-fourth (1/4) of an inch per foot (20.9 mm/m) toward the point of disposal.

**Exception:** When approved by the Authority Having Jurisdiction and where it is impractical, due to the depth of the street sewer or to the structural features or to the arrangement of any building or structure, to obtain a slope of one-fourth (1/4) of an inch per foot (20.9 mm/m), any such pipe or piping four (4) inches (100 mm) through six (6) inches (150 mm) may have a slope of not less than one-eighth (1/8) inch per foot (10.5 mm/m) and any such piping eight (8) inches (200 mm) and larger may have a slope of not less than one-sixteenth (1/16) of an inch per foot (5.3 mm/m).

**718.2** Building sewer piping shall be laid on a firm bed throughout its entire length, and any such piping laid in made or filled-in ground shall be laid on a bed of approved materials and shall be adequately supported to the satisfaction of the Authority Having Jurisdiction.

**718.3** No building sewer or other drainage piping or part thereof, which is constructed of materials other than those approved for use under or within a building, shall be installed under or within two (2) feet (610 mm) of any building or structure, or part thereof, nor less than one (1) foot (305 mm) below the surface of the ground. The provisions of this subsection include structures such as porches and steps, whether covered or uncovered, breezeways, roofed porte cocheres, roofed patios, carports, covered walks, covered driveways, and similar structures or appurtenances.

#### **719.0 Cleanouts.**

**719.1** Cleanouts shall be placed inside the building near the connection between the building drain and the building sewer or installed outside the building at the lower end of the building drain and extended to grade.

Additional building sewer cleanouts shall be installed at intervals not to exceed one hundred (100) feet (30,480 mm) in straight runs and for each aggregate horizontal change in direction exceeding one hundred thirty-five (135) degrees (2.36 rad).

**719.2** When a building sewer or a branch thereof does not exceed ten (10) feet (3048 mm) in length and is a straight-line projection from a building drain which is provided with a cleanout, no cleanout will be required at its point of connection to the building drain.

**719.3** All required building sewer cleanouts shall be extended to grade and shall comply with all appropriate sections of Cleanouts, Section 707.0, for sizing, construction and materials. When building sewers are located under buildings, the cleanout requirements of Section 707.0 shall apply.

**719.4** Each cleanout shall be installed so that it opens to allow cleaning in the direction of flow of the soil or waste or at right angles thereto and, except in the case of wye branch and end-of-line cleanouts, shall be installed vertically above the flow line of the pipe.

**719.5** Cleanouts installed under concrete or asphalt paving shall be made accessible by yard boxes or by extending flush with paving with approved materials and shall be adequately protected.

**719.6** Approved manholes may be installed in lieu of cleanouts when first approved by the Authority Having Jurisdiction. The maximum distance between manholes shall not exceed three hundred (300) feet (91.4 m).

The inlet and outlet connections shall be made by the use of a flexible compression joint no closer than twelve (12) inches (305 mm) to and not farther than three (3) feet (914 mm) from the manhole. No flexible compression joints shall be embedded in the manhole base.

#### **720.0 Sewer and Water Pipes.**

Building sewers or drainage piping of clay or materials which are not approved for use within a building shall not be run or laid in the same trench as the water pipes unless both of the following requirements are met:

- (1) The bottom of the water pipe, at all points, shall be at least twelve (12) inches (305 mm) above the top of the sewer or drain line.
- (2) The water pipe shall be placed on a solid shelf excavated at one side of the common

trench with a minimum clear horizontal distance of at least twelve (12) inches (305 mm) from the sewer or drain line.

Water pipes crossing sewer or drainage piping constructed of clay or materials which are not approved for use within a building shall be laid a minimum of twelve (12) inches (305 mm) above that sewer or drain pipe.

**Note:**

For the purpose of this section, “within the building” shall mean within the fixed limits of the building foundation.

**721.0 Location.**

**721.1** Except as provided in Section 721.2, no building sewer shall be located in any lot other than the lot which is the site of the building or structure

served by such sewer nor shall any building sewer be located at any point having less than the minimum distances indicated in Table 7-7.

**721.2** Nothing contained in this code shall be construed to prohibit the use of all or part of an abutting lot to:

- (1) Provide access to connect a building sewer to an available public sewer when proper cause and legal easement not in violation of other requirements has been first established to the satisfaction of the Authority Having Jurisdiction.
- (2) Provide additional space for a building sewer when proper cause, transfer of ownership, or change of boundary not in violation of other requirements has been first established to the satisfaction of the Authority Having Jurisdiction. The instrument recording such action shall constitute an agreement with the Authority Having Jurisdiction and shall clearly state and

**TABLE 7-7  
Minimum Horizontal Distance Required From Building Sewer**

Buildings or structures <sup>1</sup> .....	2 feet	(610 mm)
Property line adjoining private property.....	Clear <sup>2</sup>	
Water supply wells.....	50 feet <sup>3</sup>	(15,240 mm)
Streams .....	50 feet	(15,240 mm)
On-site domestic water service line.....	1 foot <sup>4</sup>	(305 mm)
Public water main .....	10 feet <sup>5,6</sup>	(3,048 mm)

**Note:**

- <sup>1</sup> Including porches and steps, whether covered or uncovered, breezeways, roofed portecocheres, roofed patios, carports, covered walks, covered driveways, and similar structures or appurtenances.
- <sup>2</sup> See also Section 313.3.
- <sup>3</sup> All drainage piping shall clear domestic water supply wells by at least fifty (50) feet (15240 mm). This distance may be reduced to not less than twenty-five (25) feet (7620 mm) when the drainage piping is constructed of materials approved for use within a building.
- <sup>4</sup> See Section 720.0.
- <sup>5</sup> For parallel construction.
- <sup>6</sup> For crossings, approval by the Health Department or Authority Having Jurisdiction shall be required.

**TABLE 7-8  
Maximum/Minimum Fixture Unit Loading on Building Sewer Piping**

Size of Pipe, Inches (mm)	Slope, Inches per Foot (mm/m)		
	1/16 (5.3)	1/8 (10.5)	1/4 (20.9)
6 and smaller (150)	(As specified in Table 7-5/No minimum loading)		
8 (200)	1,950/1,500	2,800/625	3,900/275
10 (250)	3,400/1,600	4,900/675	6,800/300
12 (300)	5,600/1,700	8,000/725	11,200/325

See also Appendix K, Private Sewage Disposal Systems. For alternate methods of sizing drainage piping, see Appendix L.

show that the areas so joined or used shall be maintained as a unit during the time they are so used. Such an agreement shall be recorded in the office of the County Recorder as part of the conditions of ownership of said properties, and shall be binding on all heirs, successors, and assigns to such properties. A copy of the instrument recording such proceedings shall be filed with the Authority Having Jurisdiction.

#### **722.0 Abandoned Sewers and Sewage Disposal Facilities.**

**722.1** Every abandoned building (house) sewer, or part thereof, shall be plugged or capped in an approved manner within five (5) feet (1524 mm) of the property line.

**722.2** Every cesspool, septic tank, and seepage pit which has been abandoned or has been discontinued otherwise from further use or to which no waste or soil pipe from a plumbing fixture is connected shall have the sewage removed therefrom and be completely filled with earth, sand, gravel, concrete, or other approved material.

**722.3** The top cover or arch over the cesspool, septic tank, or seepage pit shall be removed before filling, and the filling shall not extend above the top of the vertical portions of the sidewalls or above the level of any outlet pipe until inspection has been called and the cesspool, septic tank, or seepage pit has been inspected. After such inspection, the cesspool, septic tank, or seepage pit shall be filled to the level of the top of the ground.

**722.4** No person owning or controlling any cesspool, septic tank, or seepage pit on the premises of such person or in that portion of any public street, alley, or other public property abutting such premises, shall fail, refuse, or neglect to comply with the provisions of this section or upon receipt of notice so to comply from the Authority Having Jurisdiction.

**722.5** Where disposal facilities are abandoned consequent to connecting any premises with the public sewer, the permittee making the connection shall fill all abandoned facilities as required by the Authority Having Jurisdiction within thirty (30) days from the time of connecting to the public sewer.

#### **723.0 Building Sewer Test.**

Building sewers shall be tested by plugging the end of the building sewer at its points of connection with the public sewer or private sewage disposal system and completely filling the building sewer with water from the lowest to the highest point thereof, or by approved equivalent low-pressure air test. The building sewer shall be watertight at all points.

## CHAPTER 8

### INDIRECT WASTES

#### 801.0 Indirect Wastes.

**801.1 Airgap or Airbreak Required.** All indirect waste piping shall discharge into the building drainage system through an airgap or airbreak as set forth in this code. Where a drainage airgap is required by this code, the minimum vertical distance as measured from the lowest point of the indirect waste pipe or the fixture outlet to the flood-level rim of the receptor shall be not less than one (1) inch (25.4 mm).

**801.2 Food and Beverage Handling Establishments.** Establishments engaged in the storage, preparation, selling, serving, processing, or other handling of food and beverage involving the following equipment which requires drainage shall provide indirect waste piping for refrigerators, refrigeration coils, freezers, walk-in coolers, iceboxes, ice-making machines, steam tables, egg boilers, coffee urns and brewers, hot-and-cold drink dispensers, and similar equipment.

**801.2.1** Except for refrigeration coils and ice-making machines, the minimum size of the indirect waste pipe shall not be smaller than the drain on the unit, but shall not be smaller than one (1) inch (25 mm), and the maximum developed length shall not exceed fifteen (15) feet (4572 mm). Indirect waste pipe for ice-making machines shall not be less than the drain on the unit, but shall not be less than three-quarters (3/4) inch (20 mm).

**801.2.2** For walk-in coolers, floor drains may be connected to a separate drainage line discharging into an outside receptor. The flood-level rim of the receptor shall be a minimum of six (6) inches (152 mm) lower than the lowest floor drain. Such floor drains shall be trapped and individually vented. Cleanouts shall be provided at every ninety (90) degree (1.6 rad) turn and shall be accessibly located. Such waste shall discharge through an airgap or airbreak into a trapped and vented receptor, except that a full-size airgap is required where the indirect waste pipe may be under vacuum.

**801.2.3** Food preparation sinks, steam kettles, potato peelers, ice cream dipper wells, and similar equipment shall be indirectly connected to the drainage system by means of an airgap. Bins, sinks, and other equipment having drainage connections and used for the storage of

unpackaged ice used for human ingestion, or used in direct contact with ready-to-eat food, shall be indirectly connected to the drainage system by means of an airgap. Each indirect waste pipe from food-handling fixtures or equipment shall be separately piped to the indirect waste receptor and shall not combine with other indirect waste pipes. The piping from the equipment to the receptor shall not be smaller than the drain on the unit, and it shall not be smaller than one-half (1/2) inch (15 mm).

**801.3 Bar and Fountain Sink Traps.** Where the sink in a bar, soda fountain, or counter is so located that the trap serving the sink cannot be vented, the sink drain shall discharge through an airgap or airbreak (see Section 801.2.3) into an approved receptor which is vented. The developed length from the fixture outlet to the receptor shall not exceed five (5) feet (1524 mm).

**801.4 Connections from Water Distribution System.** Indirect waste connections shall be provided for drains, overflows, or relief pipes from potable water pressure tanks, water heaters, boilers, and similar equipment which is connected to the potable water distribution system. Such indirect waste connections shall be made by means of a water distribution airgap constructed in accordance with Table 6-3.

**801.5 Sterilizers.** Lines, devices, or apparatus such as stills, sterilizers, and similar equipment requiring waste connections and used for sterile materials shall be indirectly connected by means of an airgap. Each such indirect waste pipe shall be separately piped to the receptor and shall not exceed fifteen (15) feet (4572 mm). Such receptors shall be located in the same room.

**801.6 Drip or Drainage Outlets.** Appliances, devices, or apparatus not regularly classed as plumbing fixtures, but which have drip or drainage outlets, may be drained by indirect waste pipes discharging into an open receptor through either an airgap or airbreak (see Section 801.2.1).

#### 802.0 Approvals.

No plumbing fixtures served by indirect waste pipes or receiving discharge therefrom shall be installed until first approved by the Authority Having Jurisdiction.

**803.0 Indirect Waste Piping.**

Except as hereinafter provided, the size and construction of indirect waste piping shall be in accordance with other sections of this code applicable to drainage and vent piping. No vent from indirect waste piping shall combine with any sewer connected vent, but shall extend separately to the outside air. Indirect waste pipes exceeding five (5) feet (1524 mm), but less than fifteen (15) feet (4572 mm) in length shall be directly trapped, but such traps need not be vented.

Indirect waste pipes less than fifteen (15) feet (4572 mm) in length shall not be less than the diameter of the drain outlet or tailpiece of the fixture, appliance, or equipment served, and in no case less than one-half (1/2) inch (15 mm) in size. Angles and changes of direction in such indirect waste pipes shall be provided with cleanouts so as to permit flushing and cleaning.

**804.0 Indirect Waste Receptors.**

**804.1** All plumbing fixtures or other receptors receiving the discharge of indirect waste pipes shall be approved for the use proposed and shall be of such shape and capacity as to prevent splashing or flooding and shall be located where they are readily accessible for inspection and cleaning. No standpipe receptor for any clothes washer shall extend more than thirty (30) inches (762 mm), nor less than eighteen (18) inches (457 mm) above its trap. No trap for any clothes washer standpipe receptor shall be installed below the floor, but shall be roughed in not less than six (6) inches (152 mm) and not more than eighteen (18) inches (457 mm) above the floor. No indirect waste receptor shall be installed in any toilet room, closet, cupboard, or storeroom, nor in any other portion of a building not in general use by the occupants thereof; except standpipes for clothes washers may be installed in toilet and bathroom areas when the clothes washer is installed in the same room.

**804.2** Where water service connections are installed for a clothes washer, an approved method of waste disposal shall be provided.

**805.0 Pressure Drainage Connections.**

Indirect waste connections shall be provided for drains, overflows, or relief vents from the water supply system, and no piping or equipment carrying wastes or producing wastes or other discharges under pressure shall be directly connected to any part of the drainage system.

The foregoing shall not apply to any approved sump pump or to any approved pressure-wasting plumbing fixture or device when the Authority Having Jurisdiction has been satisfied that the

drainage system is adequately sized to accommodate the anticipated discharge thereof.

**806.0 Sterile Equipment.**

Appliances, devices, or apparatus such as stills, sterilizers, and similar equipment requiring water and waste and used for sterile materials shall be drained through an airgap.

**807.0 Appliances.**

**807.1** Appliances, devices, equipment, or other apparatus not regularly classed as plumbing fixtures which are equipped with pumps, drips, or drainage outlets may be drained by indirect waste pipes discharging into an approved type of open receptor.

**807.2** When the condensate waste from air-conditioning coils discharges by direct connection to a lavatory tailpiece or to an approved accessible inlet on a bathtub overflow, the connection shall be located in the area controlled by the same person controlling the air-conditioned space.

**807.3** When undiluted condensate waste from a fuel-burning condensing appliance is discharged into the drainage system, the material in the drainage system shall be cast iron, galvanized iron, plastic, or other materials approved for this use.

**Exceptions:**

- (1) When the above condensate is discharged to an exposed fixture tailpiece and trap, such tailpiece and trap may be brass.
- (2) Any materials approved in Section 701.0 may be used when, in the opinion of the Authority Having Jurisdiction, condensate waste from a fuel-burning condensing appliance is diluted either before or after discharge into the drainage system.

**807.4** No domestic dish-washing machine shall be directly connected to a drainage system or food waste disposer without the use of an approved dishwasher airgap fitting on the discharge side of the dish-washing machine. Listed airgaps shall be installed with the flood level (FL) marking at or above the flood level of the sink or drainboard, whichever is higher.

**808.0 Cooling Water.**

When permitted by the Authority Having Jurisdiction, clean running water used exclusively as a cooling medium in an appliance, device, or apparatus may discharge into the drainage system through the inlet side of a fixture trap in the event that a suitable fixture is not available to receive such discharge. Such trap connection shall be by means of a pipe connected to the inlet side of an approved fixture trap, the upper

end terminating in a funnel-shaped receptacle set adjacent, and not less than six (6) inches (152 mm) above the overflow rim of the fixture.

**809.0 Drinking Fountains.**

Drinking fountains may be installed with indirect wastes.

**810.0 Steam and Hot Water Drainage Condensers and Sumps.**

**810.1** No steam pipe shall be directly connected to any part of a plumbing or drainage system, nor shall any water having a temperature above one hundred and forty (140)°F (60°C) be discharged under pressure directly into any part of a drainage system. Pipes from boilers shall discharge by means of indirect waste piping, as determined by the Authority Having Jurisdiction or the boiler manufacturer’s recommendations. Such pipes may be indirectly connected by discharging into an open or closed condenser or an intercepting sump of an approved type that will prevent the entrance of steam or such water under pressure into the drainage system. All closed condensers or sumps shall be provided with a vent which shall be taken off the top and extended separately, full size above the roof. All condensers and sumps shall be properly trapped at the outlet with a deep seal trap extending to within six (6) inches (152 mm) of the bottom of the tank. The top of the deep seal trap shall have a three-fourths (3/4) inch (19.1 mm) opening located at the highest point of the trap to serve as a siphon breaker. Outlets shall be taken off from the side in such a manner as to allow a water line to be maintained that will permanently occupy not less than one-half (1/2) the capacity of the condenser or sump. All inlets shall enter above the water line. Wearing plates or baffles shall be installed in the tank to protect the shell. The sizes of the blowoff line inlet, the water outlets, and the vent shall be as shown in Table 8-1. The contents of condensers receiving steam or hot water under pressure must pass through an open sump before entering the drainage system.

**810.2** Sumps, condensers, or intercepting tanks which are constructed of concrete shall have walls and bottom not less than four (4) inches (102 mm) in thickness, and the inside shall be cement plastered not less than one-half (1/2) inch (12.7 mm) in thickness. Condensers constructed of metal shall be not less than No. 12 U.S. Standard gauge (0.109 inch) (2.77 mm), and all such metal condensers shall be protected from external corrosion by an approved bituminous coating.

**810.3** Sumps and condensers shall be provided with suitable means of access for cleaning and shall contain a volume of not less than twice the volume of

water removed from the boiler or boilers connected thereto when the normal water level of such boiler or boilers is reduced not less than four (4) inches (102 mm).

**TABLE 8-1  
Pipe Connections in Blowoff Condensers and Sumps**

Boiler Blowoff		Water Outlet		Vent	
3/4 in.*	(20 mm)	3/4 in.*	(20 mm)	2 in.	(50 mm)
1 in.	(25 mm)	1 in.	(25 mm)	2-1/2 in.	(65 mm)
1-1/4 in.	(32 mm)	1-1/4 in.	(32 mm)	3 in.	(80 mm)
1-1/2 in.	(40 mm)	1-1/2 in.	(40 mm)	4 in.	(100 mm)
2 in.	(50 mm)	2 in.	(50 mm)	5 in.	(125 mm)
2-1/2 in.	(65 mm)	2-1/2 in.	(65 mm)	6 in.	(150 mm)

\*To be used only with boilers of 100 square feet (9.29 m<sup>2</sup>) of heating surface or less.

**810.4 Strainers.** Every indirect waste interceptor receiving discharge-containing particles that would clog the receptor drain shall have a readily removable beehive strainer.

**811.0 Chemical Wastes.**

**811.1** Chemical or industrial liquid wastes which are likely to damage or increase maintenance costs on the sanitary sewer system, detrimentally affect sewage treatment, or contaminate surface or subsurface waters shall be pretreated to render them innocuous prior to discharge into a drainage system. Detailed plans and specifications of the pretreatment facilities shall be required by the Authority Having Jurisdiction.

Piping conveying industrial, chemical, or process wastes from their point of origin to sewer-connected pretreatment facilities shall be of such material and design as to adequately perform its intended function to the satisfaction of the Authority Having Jurisdiction. Drainage discharge piping from pretreatment facilities or interceptors shall conform to standard drainage installation procedures.

Copper tube shall not be used for chemical or industrial wastes as defined in this section.

**811.2** Each waste pipe receiving or intended to receive the discharge of any fixture into which acid or corrosive chemical is placed and each vent pipe connected thereto shall be constructed of chemical-resistant glass, high-silicon iron pipe, or lead pipe with a wall thickness of not less than one-eighth (1/8) inch (3.2 mm), an approved type of ceramic glazed or



unglazed vitrified clay, or other approved corrosion-resistant materials.

**811.3** All jointing materials shall be of approved type and quality.

**811.4** Wherever practicable, all piping shall be readily accessible and installed with the maximum of clearance from other services.

**811.5** The owner shall make and keep a permanent record of the location of all piping and venting carrying chemical waste.

**811.6** No chemical vent shall intersect vents for other services.

**811.7** No chemical wastes shall be discharged into the ground, local sewer, or other means without approval of the local Authority Having Jurisdiction.

**811.8** The provisions in this section relative to materials and methods of construction shall not apply to installations such as photographic or X-ray dark rooms or research or control laboratories where minor amounts of adequately diluted chemicals are discharged.

**812.0 Clear Water Wastes.**

Water lifts, expansion tanks, cooling jackets, sprinkler systems, drip or overflow pans, or similar devices which discharge clear wastewater into the building drainage system shall discharge through an indirect waste.

**813.0 Swimming Pools.**

Pipes carrying wastewater from swimming or wading pools, including pool drainage and backwash from filters, shall be installed as an indirect waste. Where a pump is used to discharge waste pool water to the drainage system, the pump discharge shall be installed as an indirect waste.

**814.0 RESERVED**

**815.0 Condensate Wastes and Control.**

**815.1 Condensate Disposal.** Condensate from air washers, air cooling coils, fuel-burning condensing appliances, the overflow from evaporative coolers and similar water-supplied equipment or similar air-conditioning equipment shall be collected and discharged to an approved plumbing fixture or disposal area. If discharged into the drainage system, equipment shall drain by means of an indirect waste pipe. The waste pipe shall have a slope of not less than 1/8 inch per foot (10.5 mm/m) or one percent slope and shall be of approved corrosion-resistant material not smaller than the outlet size as required in either Section 310.3 or 310.4 below for air-cooling

coils or condensing fuel-burning appliances, respectively. Condensate or wastewater shall not drain over a public way.

**815.2 Size.** Air-conditioning condensate waste pipes shall be independent of any drainage and waste system and shall not be smaller than shown in Table 8-2.

**TABLE 8-2**  
**Minimum Condensate Pipe Size**

Equipment Capacity in Tons of Refrigeration (kW)	Minimum Condensate Pipe Diameter	
	in Inches	(mm)
Up to 20 (Up to 70.34)	3/4	(20)
21-40 (73.85-140.67)	1	(25)
41-90 (144.19-316.6)	1-1/4	(32)
91-125 (320.03-439.6)	1-1/2	(40)
126-250 (443.12-879.2)	2	(50)

The size of condensate waste pipes may be for one unit or a combination of units, or as recommended by the manufacturer. The capacity of waste pipes assumes a one-eighth (1/8) inch per foot (10.5 mm/m) or one percent slope, with the pipe running three-quarters (3/4) full at the following conditions:

Outside Air – 20%		Room Air – 80%	
DB	WB	DB	WB
90°F	73°F	75°F	62.5°F
(32°C)	(23°C)	(24°C)	(17°)

Condensate drain sizing for other slopes or other conditions shall be approved by the Authority Having Jurisdiction.

Air-conditioning waste pipes shall be constructed of materials specified in Chapter 7.

**815.3 Point of Discharge.** Air-conditioning condensate waste pipes shall connect indirectly to the drainage system through an airgap or airbreak to:

**815.3.1** A properly trapped receptor or

**815.3.2** Other points of discharge acceptable to the Authority Having Jurisdiction, including dry wells, leach pits, the tailpiece of plumbing fixtures, and so on.

**815.3.3** Condensate or waste water shall not drain over a public way.

## CHAPTER 9

### VENTS

#### 901.0 Vents Required.

Each plumbing fixture trap, except as otherwise provided in this code, shall be protected against siphonage and back-pressure, and air circulation shall be ensured throughout all parts of the drainage system by means of vent pipes installed in accordance with the requirements of this chapter and as otherwise required by this code.

#### 902.0 Vents Not Required.

**902.1** Where permitted by the Authority Having Jurisdiction, vent piping may be omitted on an interceptor when such interceptor acts as a primary settling tank and discharges through a horizontal indirect waste pipe into a secondary interceptor. The second interceptor shall be properly trapped and vented.

**902.2** Traps serving sinks which are part of the equipment of bars, soda fountains, and counters need not be vented when the location and construction of such bars, soda fountains, and counters is such as to make it impossible to do so. When such conditions exist, said sinks shall discharge by means of approved indirect waste pipes into a floor sink or other approved type of receptor.

#### 903.0 Materials.

**903.1** Vent pipe shall be cast iron, galvanized steel, galvanized wrought iron, copper, brass, Schedule 40 ABS DWV, Schedule 40 PVC DWV, or other approved materials having a smooth and uniform bore except that:

**903.1.1** No galvanized wrought iron or galvanized steel pipe shall be used underground and shall be kept at least six (6) inches (152 mm) above ground.

**903.1.2** ABS and PVC DWV piping installations shall be installed in accordance with IS 5, IS 9 and Chapter 15 "Firestop Protection." Except for individual single-family dwelling units, materials exposed within ducts or plenums shall have a flame-spread index of not more than 25 and a smoke-developed index of not more than 50 when tested in accordance with the Test for Surface-Burning Characteristics of the Building Materials (See the Building Code standards based on ASTM E-84 and ANSI/UL 723.).

#### 903.2 Use of Copper Tubing.

**903.2.1** Copper tube for underground drainage and vent piping shall have a weight of not less than that of copper drainage tube type DWV.

**903.2.2** Copper tube for aboveground drainage and vent piping shall have a weight of not less than that of copper drainage tube type DWV.

**903.2.3** Copper tube shall not be used for chemical or industrial wastes as defined in Section 811.0.

**903.2.4** In addition to the required incised marking, all hard-drawn copper tubing shall be marked by means of a continuous and indelibly colored stripe at least one quarter (1/4) inch (6.4 mm) in width, as follows: Type K, green; Type L, blue; Type M, red; Type DWV, yellow.

**903.3** Vent fittings shall be cast iron, galvanized malleable iron or galvanized steel, copper, brass, ABS, PVC, or other approved materials, except that no galvanized malleable iron or galvanized steel fittings shall be used underground and shall be kept at least six (6) inches (152 mm) above ground.

**903.4** Changes in direction of vent piping shall be made by the appropriate use of approved fittings, and no such pipe shall be strained or bent. Burred ends shall be reamed to the full bore of the pipe.

#### 904.0 Size of Vents.

**904.1** The size of vent piping shall be determined from its length and the total number of fixture units connected thereto, as set forth in Table 7-5. The diameter of an individual vent shall not be less than one and one-fourth (1-1/4) inches (32 mm) nor less than one-half (1/2) the diameter of the drain to which it is connected. In addition, the drainage piping of each building and each connection to a public sewer or a private sewage disposal system shall be vented by means of one or more vent pipes, the aggregate cross-sectional area of which shall not be less than that of the largest required building sewer, as determined from Table 7-5. Vent pipes from fixtures located upstream from pumps, ejectors, backwater valves, or other devices which in any way obstruct the free flow of air and other gases between the building sewer and the outside atmosphere shall not be used for meeting the cross-sectional area venting requirements of this section.

**Exception:** When connected to a common building sewer, the drainage piping of two (2) or more buildings located on the same lot and under one (1) ownership may be vented by means of piping sized in accordance with Table 7-5, provided the aggregate cross-sectional area of all vents is not less than that of the largest required common building sewer.

**904.2** No more than one-third (1/3) of the total permitted length, per Table 7-5, of any minimum sized vent shall be installed in a horizontal position.

**Exception:** When a minimum sized vent is increased one (1) pipe size for its entire length, the maximum length limitation does not apply.

### 905.0 Vent Pipe Grades and Connections.

**905.1** All vent and branch vent pipes shall be free from drops or sags, and each such vent shall be level or shall be so graded and connected as to drip back by gravity to the drainage pipe it serves.

**905.2** Where vents connect to a horizontal drainage pipe, each vent pipe shall have its invert taken off above the drainage centerline of such pipe downstream of the trap being served.

**905.3** Unless prohibited by structural conditions, each vent shall rise vertically to a point not less than six (6) inches (152 mm) above the flood level rim of the fixture served before offsetting horizontally, and whenever two or more vent pipes converge, each such vent pipe shall rise to a point at least six (6) inches (152 mm) in height above the flood level rim of the plumbing fixture it serves before being connected to any other vent. Vents less than six (6) inches (152 mm) above the flood level rim of the fixture shall be installed with approved drainage fittings, material, and grade to the drain.

**905.4** All vent pipes shall extend undiminished in size above the roof, or shall be reconnected with a soil or waste vent of proper size.

**905.5** The vent pipe opening from a soil or waste pipe, except for water closets and similar fixtures, shall not be below the weir of the trap.

**905.6** Two (2) fixtures may be served by a common vertical pipe when each such fixture wastes separately into an approved double fitting having inlet openings at the same level.

### 906.0 Vent Termination.

**906.1** Each vent pipe or stack shall extend through its flashing and shall terminate vertically not less than six (6) inches (152 mm) above the roof nor less than one (1) foot (305 mm) from any vertical surface.

**906.2** Each vent shall terminate not less than ten (10) feet (3048 mm) from, or at least three (3) feet (914 mm) above, any openable window, door, opening, air intake, or vent shaft, nor less than three (3) feet (914 mm) in every direction from any lot line-alley and street excepted.

**906.3** Vent pipes shall be extended separately or combined, of full required size, not less than six (6) inches (152 mm) above the roof or fire wall. Flagpoling of vents shall be prohibited except where the roof is used for purposes other than weather protection. All vents within ten (10) feet (3048 mm) of any part of the roof that is used for such other purposes shall extend not less than seven (7) feet (2134 mm) above such roof and shall be securely stayed.

**906.4** Vent pipes for outdoor installations shall extend at least ten (10) feet (3048 mm) above the surrounding ground and shall be securely supported.

**906.5** Joints at the roof around vent pipes shall be made watertight by the use of approved flashings or flashing material.

**906.6 Lead.** See Table 14-1. Sheet lead shall be not less than the following:

For safe pans – not less than four (4) pounds per square foot (19.5 kg/m<sup>2</sup>) or 1/16 inch (1.6 mm) thick.

For flashings or vent terminals – not less than three (3) pounds per square foot (14.7 kg/m<sup>2</sup>) or 1.2 mm thick.

Lead bends and lead traps shall not be less than one-eighth (1/8) inch (3.2 mm) wall thickness.

**906.7 Frost or Snow Closure.** Where frost or snow closure is likely to occur in locations having minimum design temperature below 0°F (-17.8°C), vent terminals shall be a minimum of two (2) inches (51 mm) in diameter, but in no event smaller than the required vent pipe. The change in diameter shall be made inside the building at least one (1) foot (305 mm) below the roof in an insulated space and terminate not less than ten (10) inches (254 mm) above the roof, or as required by the Authority Having Jurisdiction.

### 907.0 Vent Stacks and Relief Vents.

**907.1** Each drainage stack which extends ten (10) or more stories above the building drain or other horizontal drain, shall be served by a parallel vent stack which shall extend undiminished in size from its upper terminal and connect to the drainage stack at or immediately below the lowest fixture drain. Each such vent stack shall also be connected to the drainage stack at each fifth floor, counting down from the uppermost fixture drain, by means of a yoke vent, the

size of which shall be not less in diameter than either the drainage or the vent stack, whichever is smaller.

**907.2** The yoke vent connection to the vent stack shall be placed not less than forty-two (42) inches (1067 mm) above the floor level, and the yoke vent connection to the drainage stack shall be by means of a wye-branch fitting placed below the lowest drainage branch connection serving that floor.

### **908.0 Vertical Wet Venting.**

**908.1** Wet venting is limited to vertical drainage piping receiving the discharge from the trap arm of one (1) and two (2) fixture unit fixtures that also serves as a vent for not to exceed four (4) fixtures. All wet-vented fixtures shall be within the same story; provided, further, that fixtures with a continuous vent discharging into a wet-vent shall be within the same story as the wet-vented fixtures. No wet vent shall exceed six (6) feet (1829 mm) in developed length.

**908.2** The vertical piping between any two (2) consecutive inlet levels shall be considered a wet-vented section. Each wet-vented section shall be a minimum of one (1) pipe size larger than the required minimum waste pipe size of the upper fixture or shall be one (1) pipe size larger than the required minimum pipe size for the sum of the fixture units served by such wet-vented section, whichever is larger, but in no case less than two (2) inches (51 mm).

**908.3** Common vent sizing shall be the sum of the fixture units served but in no case smaller than the minimum vent pipe size required for any fixture served, or by Section 904.0.

### **909.0 Special Venting for Island Fixtures.**

Traps for island sinks and similar equipment shall be roughed in above the floor and may be vented by extending the vent as high as possible, but not less than the drainboard height and then returning it downward and connecting it to the horizontal sink drain immediately downstream from the vertical fixture drain. The return vent shall be connected to the horizontal drain through a wye-branch fitting and shall, in addition, be provided with a foot vent taken off the vertical fixture vent by means of a wye branch immediately below the floor and extending to the nearest partition and then through the roof to the open air or may be connected to other vents at a point not less than six (6) inches (152 mm) above the flood-level rim of the fixtures served. Drainage fittings shall be used on all parts of the vent below the floor level, and a minimum slope of one-quarter (1/4) inch per

foot (20.9 mm/m) back to the drain shall be maintained. The return bend used under the drainboard shall be a one (1) piece fitting or an assembly of a forty-five (45) degree (0.79 rad), a ninety (90) degree (1.6 rad), and a forty-five (45) degree (0.79 rad) elbow in the order named. Pipe sizing shall be as elsewhere required in this code. The island sink drain, upstream of the returned vent, shall serve no other fixtures. An accessible cleanout shall be installed in the vertical portion of the foot vent.

### **910.0 Combination Waste and Vent Systems.**

**910.1** Combination waste and vent systems shall be permitted only where structural conditions preclude the installation of conventional systems as otherwise prescribed by this code.

**910.2** Plans and specifications for each combination waste and vent system shall first be approved by the Authority Having Jurisdiction before any portion of any such system is installed.

**910.3** Each combination waste and vent system, as defined in Chapter 2, shall be provided with a vent or vents adequate to ensure free circulation of air. Any branch more than fifteen (15) feet (4572 mm) in length shall be separately vented in an approved manner. The minimum area of any vent installed in a combination waste and vent system shall be at least one-half (1/2) the inside cross-sectional area of the drain pipe served. The vent connection shall be downstream of the uppermost fixture.

**910.4** Each waste pipe and each trap in any such system shall be at least two (2) pipe sizes larger than the sizes required by Chapter 7 of this code, and at least two (2) pipe sizes larger than any fixture tailpiece or connection.

**910.5** Unless specifically required or permitted by the Authority Having Jurisdiction, no vertical waste pipe shall be used in any such system, except the tailpiece or connection between the outlet of a plumbing fixture and the trap therefor. Such tailpieces or connections shall be as short as possible, and in no case shall exceed two (2) feet (610 mm).

**Exception:** Branch lines may have forty-five (45) degree (0.79 rad) vertical offsets.

**910.6** Cleanouts may not be required on any wet-vented branch serving a single trap when the fixture tailpiece or connection is not less than two (2) inches (50 mm) in diameter and provides ready access for cleaning through the trap. An accessible cleanout shall be installed in each vent for the combination waste and vent system.

**910.7** No water closet or urinal shall be installed on any such system. Other one (1), two (2), or three (3) unit fixtures remotely located from the sanitary system and adjacent to a combination waste and vent system may be connected to such system in the conventional manner by means of waste and vent pipes of regular sizes, providing that the two (2) pipe size increase required in Section 910.4 is based on the total fixture unit load connected to the system.

**Note:**

→ See Appendix B of this code for explanatory notes on the design of combination waste and vent systems.

# CHAPTER 10

## TRAPS AND INTERCEPTORS

### 1001.0 Traps Required.

**1001.1** Each plumbing fixture, excepting those having integral traps or as permitted in Section 1001.2, shall be separately trapped by an approved type of waterseal trap. Not more than one (1) trap shall be permitted on a trap arm.

**1001.2** One (1) trap may serve a set of not more than three (3) single compartment sinks or laundry tubs of the same depth or three (3) lavatories immediately adjacent to each other and in the same room if the waste outlets are not more than thirty (30) inches (762 mm) apart and the trap is centrally located when three (3) compartments are installed.

**1001.3** No food waste disposal unit shall be installed with any set of restaurant, commercial, or industrial sinks served by a single trap; each such food waste disposal unit shall be connected to a separate trap. Each domestic clothes washer and each laundry tub shall be connected to a separate and independent trap, except that a trap serving a laundry tub may also receive the waste from a clothes washer set adjacent thereto. No clothes washer or laundry tub shall be connected to any trap for a kitchen sink.

**1001.4** The vertical distance between a fixture outlet and the trap weir shall be as short as practicable, but in no case shall the tailpiece from any fixture exceed twenty-four (24) inches (610 mm) in length.

### 1002.0 Traps Protected by Vent Pipes.

**1002.1** Each plumbing fixture trap, except as otherwise provided in this code, shall be protected against siphonage and back-pressure, and air circulation shall be assured throughout all parts of the drainage system by means of a vent pipe installed in accordance with the requirements of this code.

**1002.2** Each fixture trap shall have a protecting vent so located that the developed length of the trap arm from the trap weir to the inner edge of the vent shall be within the distance given in Table 10-1, but in no case less than two (2) times the diameter of the trap arm.

**1002.3** A trap arm may change direction without the use of a cleanout when such change of direction does not exceed ninety (90) degrees (1.6 rad). All horizontal changes in direction of trap arms shall comply with Section 706.3.

**Exception:** For trap arms three (3) inches (80 mm) in diameter and larger, the change of direction shall not exceed one hundred and

thirty-five (135) degrees (2.36 rad) without the use of a cleanout.

**1002.4** The vent pipe opening from a soil or waste pipe, except for water closets and similar fixtures, shall not be below the weir of the trap.

**TABLE 10-1**  
**Horizontal Distance of Trap Arms**  
**(Except for water closets and similar fixtures)\***

Trap Arm Inches	Distance Trap to Vent		Distance Trap to Vent	
	Feet	Inches	mm	mm
1-1/4	2	6	32	762
1-1/2	3	6	40	1067
2	5	0	50	1524
3	6	0	80	1829
4 & larger	10	0	100 & larger	3048

Slope one-fourth (1/4) inch per foot (20.9 mm/m)

\*The developed length between the trap of a water closet or similar fixture (measured from the top of the closet ring [closet flange] to the inner edge of the vent) and its vent shall not exceed six (6) feet (1829 mm).

### 1003.0 Traps — Described.

**1003.1** Each trap, except for traps within an interceptor or similar device shall be self-cleaning. Traps for bathtubs, showers, lavatories, sinks, laundry tubs, floor drains, urinals, drinking fountains, dental units, and similar fixtures shall be of standard design and weight and shall be of ABS, cast brass, cast iron, lead, PP, PVC, or other approved material. An exposed and readily accessible drawn-brass tubing trap, not less than 17 B&S Gauge (0.045 inch) (1.1 mm), may be used on fixtures discharging domestic sewage.

**Exception:** Drawn-brass tubing traps shall not be used for urinals. Each trap shall have the manufacturer's name stamped legibly in the metal of the trap, and each tubing trap shall have the gauge of the tubing in addition to the manufacturer's name. Every trap shall have a smooth and uniform interior waterway.

**1003.2** No more than one (1) approved slip joint fitting may be used on the outlet side of a trap, and no tubing trap shall be installed without a listed tubing trap adapter.

**1003.3** The size (nominal diameter) of a trap for a given fixture shall be sufficient to drain the fixture rapidly, but in no case less than nor more than one (1) pipe size larger than given in Table 7-3. The trap shall be the same size as the trap arm to which it is connected.

#### **1004.0 Traps – Prohibited.**

No form of trap which depends for its seal upon the action of movable parts shall be used. No trap which has concealed interior partitions, except those of plastic, glass, or similar corrosion-resisting material, shall be used. "S" traps, bell traps, and crown-vented traps shall be prohibited. No fixture shall be double trapped. Drum and bottle traps may be installed only when permitted by the Authority Having Jurisdiction for special conditions. No trap shall be installed without a vent, except as otherwise provided in this code.

#### **1005.0 Trap Seals.**

Each fixture trap shall have a water seal of not less than two (2) inches (51 mm) and not more than four (4) inches (102 mm) except where a deeper seal is found necessary by the Authority Having Jurisdiction for special conditions or for special designs relating to handicapped-accessible fixtures. Traps shall be set true with respect to their water seals and, where necessary, they shall be protected from freezing.

#### **1006.0 Floor Drain Traps.**

Floor drains shall connect into a trap so constructed that it can be readily cleaned and of a size to serve efficiently the purpose for which it is intended. The drain inlet shall be so located that it is at all times in full view. When subject to reverse flow of sewage or liquid waste, such drains shall be equipped with an approved backwater valve.

#### **1007.0 Trap Seal Protection.**

Floor drain or similar traps directly connected to the drainage system and subject to infrequent use shall be protected with a trap seal primer, except where not deemed necessary for safety or sanitation by the Authority Having Jurisdiction. Trap seal primers shall be accessible for maintenance.

#### **1008.0 Building Traps.**

Building traps shall not be installed except where required by the Authority Having Jurisdiction. Each building trap when installed shall be provided with a cleanout and with a relieving vent or fresh-air intake on the inlet side of the trap which need not be larger than one-half the diameter of the drain to which it connects. Such relieving vent or fresh-air intake shall be carried above grade and terminate in a screened outlet located outside the building.

#### **1009.0 Industrial Interceptors (Clarifiers) and Separators.**

**1009.1 When Required.** Interceptors (clarifiers) (including grease, oil, and sand interceptors [clarifiers], etc.) shall be provided when, in the judgment of the Authority Having Jurisdiction, they are necessary for the proper handling of liquid wastes containing grease, flammable wastes, sand, solids, acid or alkaline substances, or other ingredients harmful to the building drainage system, the public or private sewer, or to public or private sewage disposal.

**1009.2 Approval.** The size, type, and location of each interceptor (clarifier) or separator shall be approved by the Authority Having Jurisdiction in accordance with its standards. Except where otherwise specifically permitted, no wastes other than those requiring treatment or separation shall be discharged into any interceptor (clarifier).

**1009.3 Design.** Interceptors (clarifiers) for sand and similar heavy solids shall be so designed and located as to be readily accessible for cleaning and shall have a water seal of not less than six (6) inches (152 mm).

**1009.4 Relief Vent.** Interceptors (clarifiers) shall be so designed that they will not become air bound if closed covers are used. Each interceptor (clarifier) shall be properly vented.

**1009.5 Location.** Each interceptor (clarifier) cover shall be readily accessible for servicing and maintaining the interceptor (clarifier) in working and operating condition. The use of ladders or the removal of bulky equipment in order to service interceptors (clarifiers) shall constitute a violation of accessibility. Location of all interceptors (clarifiers) shall be shown on the approved building plan.

**1009.6 Maintenance of Interceptors.** Interceptors shall be maintained in efficient operating condition by periodic removal of accumulated grease, scum, oil, or other floating substances and solids deposited in the interceptor.

**1009.7 Discharge.** The waste pipe from oil and sand interceptors shall discharge as approved by the Authority Having Jurisdiction.

**1010.0 Slaughterhouses, Packing Establishments, etc.**

Every fish, fowl, and animal slaughterhouse or establishment; every fish, fowl, and meat packing or curing establishment; every soap factory, tallow-rendering, fat-rendering, and hide-curing establishment; or any other establishment; from which considerable amounts of grease are likely to be discharged into any plumbing system, sewer system, or private sewage disposal system shall be connected to and shall drain or discharge into a grease interceptor (clarifier) of an approved design for this use.

**1011.0 Minimum Requirements for Auto Wash Racks.**

Every private or public wash rack and/or floor or slab used for cleaning machinery or machine parts shall be adequately protected against storm or surface water and shall drain or discharge into an interceptor (clarifier) of an approved design for this use.

**1012.0 Commercial and Industrial Laundries.**

Laundry equipment in commercial and industrial buildings that does not have integral strainers shall discharge into an interceptor having a wire basket or similar device that is removable for cleaning and that will prevent passage into the drainage system of solids one-half (1/2) inch (12.7 mm) or larger in maximum dimension, such as string, rags, buttons, or other solid materials detrimental to the public sewerage system.

**1013.0 Bottling Establishments.** Bottling plants shall discharge their process wastes into an interceptor which will provide for the separation of broken glass or other solids, before discharging liquid wastes into the drainage system.

**1014.0 Grease Traps and Grease Interceptors.**

**1014.1** When, in the judgment of the Authority Having Jurisdiction, waste pretreatment is required, an approved type of grease trap complying with the provisions of this section shall be installed in the waste line leading from sinks, drains, and other fixtures or equipment in establishments such as restaurants, cafes, lunch counters, cafeterias, bars and clubs, hotel, hospital, sanitarium, factory or school kitchens, or other establishments where grease may be introduced into the drainage or sewage system in quantities that can effect line stoppage or hinder sewage treatment or private sewage disposal. A grease trap is not required for individual dwelling units or for any private living quarters.

**1014.2** No grease trap shall be installed which has an approved rate of flow of more than fifty-five (55) gallons per minute (3.5 L/s), nor less than twenty (20) gallons per minute (1.3 L/s), except when specially approved by the Authority Having Jurisdiction.

**1014.3** Each plumbing fixture or piece of equipment connected to a grease trap shall be provided with an approved type of vented flow control installed in a readily accessible and visible location. Flow control devices shall be so designed that the flow through such device or devices shall at no time be greater than the rated capacity of the grease trap. No flow control device having adjustable or removable parts shall be approved. The vented flow-control device shall be located such that no system vent shall be between the flow-control and the grease trap inlet. The vent or air inlet of the flow-control device shall connect with the sanitary drainage vent system as elsewhere required by this code or shall terminate through the roof of the building and shall not terminate to the free atmosphere inside the building.

**Exception:** Listed grease traps with approved type flow controls or restricting devices may be installed in an accessible location in accordance with the manufacturer's instructions.

**1014.4** Each grease trap required by this section shall have an approved rate of flow which is not less than that given in Table 10-2 for the total number of connected fixtures. The total capacity in gallons (L) of fixtures discharging into any such grease trap shall not exceed two and one-half (2-1/2) times the certified GPM (L/s) flow rate of the grease trap as per Table 10-2.

Not more than four (4) separate fixtures shall be connected to or discharged into any one (1) grease trap.

For the purpose of this section, the term "fixture" shall mean and include each plumbing fixture, appliance, apparatus, or other equipment required to be connected to or discharged into a grease trap by any provision of this section.

**1014.5** Each fixture discharging into a grease trap shall be individually trapped and vented in an approved manner.

**1014.6** Grease traps shall be maintained in efficient operating condition by periodic removal of the accumulated grease. No such collected grease shall be introduced into any drainage piping or public or private sewer.

**1014.7 RESERVED**

**1014.8 Grease Interceptors for Commercial Kitchens.** Required grease interceptors installed outdoors shall comply with the provisions of Appendix H.



**1015.0 Food Waste Disposal and Dishwasher Prohibited.**

Unless specifically required or permitted by the Authority Having Jurisdiction, no food waste disposal unit or dishwasher shall be connected to or discharge into any grease trap.

**TABLE 10-2  
Grease Traps**

Total Number of Fixtures Connected	Required Rate of Flow per Minute, Gallons	Grease Retention Capacity, Pounds
1	20	40
2	25	50
3	35	70
4	50	100

**TABLE 10-2**

Total Number of Fixtures Connected	Required Rate of Flow per Minute, Liters	Grease Retention Capacity, kg
1	76	18
2	95	22
3	132	31
4	189	45

**Grease Traps (Metric)**

**Note:**

For installations with more than four (4) fixtures, the Authority Having Jurisdiction may permit the use of larger grease traps designed not to exceed the parameters of Section 1014.4, but not to exceed seventy-five (75) GPM (284 liters per minute).

**1016.0 Sand Interceptors.**

**1016.1 Where Required.**

**1016.1.1** Whenever the discharge of a fixture or drain may contain solids or semi-solids heavier than water that would be harmful to a drainage system or cause a stoppage within the system, the discharge shall be through a sand interceptor. Multiple floor drains may discharge into one sand interceptor.

**1016.1.2** Sand interceptors are required whenever the Authority Having Jurisdiction deems it advisable to have a sand interceptor to protect the drainage system.

**1016.2 Construction and Size.**

Sand interceptors shall be built of brick or concrete, prefabricated coated steel, or other watertight material. The interceptor shall have an interior baffle for full separation of the interceptor into two (2) sections. The outlet pipe shall be the same size as the inlet size of the oil interceptor, the minimum being three (3) inches (80 mm), and the baffle shall have two (2) openings of the same diameter as the outlet pipe and at the same invert as the outlet pipe. These openings shall be staggered so that there cannot be a straight line flow between any inlet pipe and the outlet pipe. The invert of the inlet pipe shall be no lower than the invert of the outlet pipe.

The sand interceptor shall have a minimum dimension of two (2) feet square (0.2 m<sup>2</sup>) for the net free opening of the inlet section and a minimum depth under the invert of the outlet pipe of two (2) feet (610 mm).

For each five (5) gallons (18.9 L) per minute flow or fraction thereof over twenty (20) gallons (75.7 L) per minute, the area of the sand interceptor inlet section is to be increased by one (1) square foot (0.09 m<sup>2</sup>). The outlet section shall at all times have a minimum area of fifty (50) percent of the inlet section.

The outlet section shall be covered by a solid removable cover, set flush with the finished floor, and the inlet section shall have an open grating set flush with the finished floor and suitable for the traffic in the area in which it is located.

**1016.3 Separate Use.** Sand and similar interceptors for every solid shall be so designed and located as to be readily accessible for cleaning, shall have a water seal of not less than six (6) inches (152 mm), and shall be vented.

**1016.4 RESERVED**

**1017.0 Oil and Flammable Liquid Interceptors.**

**1017.1 Interceptors Required.** All repair garages and gasoline stations with grease racks or grease pits, and all factories which have oily, flammable, or both types of wastes as a result of manufacturing, storage, maintenance, repair, or testing processes, shall be provided with an oil or flammable liquid interceptor which shall be connected to all necessary floor drains. The separation or vapor compartment shall be independently vented to the outer air. If two (2) or more separation or vapor compartments are used, each shall be vented to the outer air or may connect to a header which is installed at a minimum of six (6) inches (152 mm) above the spill line of the lowest floor drain and vented independently to the

outer air. The minimum size of a flammable vapor vent shall not be less than two (2) inches (50 mm), and when vented through a sidewall, the vent shall not be less than ten (10) feet (3048 mm) above the adjacent level at an approved location. The interceptor shall be vented on the sewer side and shall not connect to a flammable vapor vent. All oil and flammable interceptors shall be provided with gastight cleanout covers which shall be readily accessible. The waste line shall not be less than three (3) inches (80 mm) in diameter with a full-size cleanout to grade. When an interceptor is provided with an overflow, it shall be provided with an overflow line (not less than two (2) inches (50 mm) in diameter) to an approved waste oil tank having a minimum capacity of five hundred fifty (550) gallons (2080 L) and meeting the requirements of the Authority Having Jurisdiction. The waste oil from the separator shall flow by gravity or shall be pumped to a higher elevation by an automatic pump. Pumps shall be adequately sized and accessible. Waste oil tanks shall have a two (2) inch (50 mm) minimum pump-out connection at grade and a one and one-half (1-1/2) inch (40 mm) minimum vent to atmosphere at an approved location at least ten (10) feet (3048 mm) above grade.

**1017.2 Design of Interceptors.** Each manufactured interceptor that is rated shall be stamped or labeled by the manufacturer with an indication of its full discharge rate in gpm (L/s). The full discharge rate to such an interceptor shall be determined at full flow. Each interceptor shall be rated equal to or greater than the incoming flow and shall be provided with an overflow line to an underground tank.

Interceptors not rated by the manufacturer shall have a depth of not less than two (2) feet (610 mm) below the invert of the discharge drain. The outlet opening shall have not less than an eighteen (18) inch (457 mm) water seal and shall have a minimum capacity as follows: where not more than three (3) motor vehicles are serviced and/or stored, interceptors shall have a minimum capacity of six (6) cubic feet (0.2 m<sup>3</sup>), and one (1) cubic foot (0.03 m<sup>3</sup>) of capacity shall be added for each vehicle up to ten (10) vehicles. Above ten (10) vehicles, the Authority Having Jurisdiction shall determine the size of the interceptor required. Where vehicles are serviced only and not stored, interceptor capacity shall be based on a net capacity of one (1) cubic foot (0.03 m<sup>3</sup>) for each one hundred (100) square feet (9.3 m<sup>2</sup>) of surface to be drained into the interceptor, with a minimum of six (6) cubic feet (0.2 m<sup>3</sup>).



# CHAPTER 11

## STORM DRAINAGE

### 1101.0 General.

**1101.1 Where Required.** All roofs, paved areas, yards, courts, and courtyards shall be drained into a separate storm sewer system, or into a combined sewer system where a separate storm sewer system is not available, or to some other place of disposal satisfactory to the Authority Having Jurisdiction. In the case of one- and two-family dwellings, storm water may be discharged on flat areas such as streets or lawns so long as the storm water shall flow away from the building and away from adjoining property, and shall not create a nuisance.

**1101.2 Storm Water Drainage to Sanitary Sewer Prohibited.** Storm water shall not be drained into sewers intended for sanitary drainage only.

**1101.3 Material Uses.** Rainwater piping placed within the interior of a building or run within a vent or shaft shall be of cast iron, galvanized steel, wrought iron, brass, copper, lead, Schedule 40 ABS DWV, Schedule 40 PVC DWV, or other approved materials, and changes in direction shall conform to the requirements of Section 706.0. ABS and PVC DWV piping installations shall be installed in accordance with IS 5, IS 9, and Chapter 15 "Firestop Protection." Except for individual single-family dwelling units, materials exposed within ducts or plenums shall have a flame-spread index of not more than 25 and a smoke-developed index of not more than 50, when tested in accordance with the Test for Surface-Burning Characteristics of the Building Materials (See the Building Code standards based on ASTM E-84 and ANSI/UL 723.).

**1101.4 Expansion Joints Required.** Expansion joints or sleeves shall be provided where warranted by temperature variations or physical conditions.

### 1101.5 Subsoil Drains.

**1101.5.1** Subsoil drains shall be provided around the perimeter of buildings having basements, cellars, or crawl spaces or floors below grade. Such subsoil drains may be positioned inside or outside of the footing, shall be of perforated or open-jointed approved drain tile or pipe not less than three (3) inches (80 mm) in diameter, and shall be laid in gravel, slag, crushed rock, approved three-quarter (3/4) inch (19.1 mm) crushed recycled glass aggregate, or other approved porous material with a minimum of four (4) inches (102 mm) surrounding the pipe on all sides. Filter media shall be provided for exterior subsoil piping.

**1101.5.2** Subsoil drains shall be piped to a storm drain, to an approved water course, to the front street curb or gutter, or to an alley or the discharge from the subsoil drains shall be conveyed to the alley by a concrete gutter. Where a continuously flowing spring or groundwater is encountered, subsoil drains shall be piped to a storm drain or an approved water course.

**1101.5.3** Where it is not possible to convey the drainage by gravity, subsoil drains shall discharge to an accessible sump provided with an approved automatic electric pump. The sump shall be at least fifteen (15) inches (375 mm) in diameter, eighteen (18) inches (457 mm) in depth, and provided with a fitted cover. The sump pump shall have an adequate capacity to discharge all water coming into the sump as it accumulates to the required discharge point, and the capacity of the pump shall not be less than fifteen (15) gpm (1.0 L/s). The discharge piping from the sump pump shall be a minimum of one and one-half (1-1/2) inches (40 mm) in diameter and have a union or other approved quick disconnect assembly to make the pump accessible for servicing.

**1101.5.4** For separate dwellings not serving continuously flowing springs or groundwater, the sump discharge pipe may discharge onto a concrete splash block with a minimum length of twenty-four (24) inches (610 mm). This pipe shall be within four (4) inches (102 mm) of the splash block and positioned to direct the flow parallel to the recessed line of the splash block.

**1101.5.5** Subsoil drains subject to backflow when discharging into a storm drain shall be provided with a backwater valve in the drain line so located as to be accessible for inspection and maintenance.

**1101.5.6** Nothing in Section 1101.5 shall prevent drains that serve either subsoil drains or areaways of a detached building from discharging to a properly graded open area, provided that:

- (1) They do not serve continuously flowing springs or groundwater;
- (2) The point of discharge is at least ten (10) feet (3048mm) from any property line; and
- (3) It is impracticable to discharge such drains to a storm drain, to an approved water course, to the front street curb or gutter, or to an alley.

**1101.6 Building Subdrains.** Building subdrains located below the public sewer level shall discharge into a sump or receiving tank, the contents of which shall be automatically lifted and discharged into the drainage system as required for building sumps.

**1101.7 Areaway Drains.** All open subsurface space adjacent to a building serving as an entrance to the basement or cellar of a building shall be provided with a drain or drains. Such areaway drains shall be two (2) inches (50 mm) minimum diameter for areaways not exceeding one hundred (100) square feet (9.3 m<sup>2</sup>) in area, and shall be discharged in the manner provided for subsoil drains not serving continuously flowing springs or groundwater (see Section 1101.5.2). Areaways in excess of one hundred (100) square feet (9.3 m<sup>2</sup>) shall not drain into subsoil. Areaway drains for areaways exceeding one hundred (100) square feet (9.3 m<sup>2</sup>) shall be sized according to Table 11-2.

**1101.8 Window Areaway Drains.** Window areaways not exceeding ten (10) square feet (0.9 m<sup>2</sup>) in area may discharge to the subsoil drains through a two (2) inch (50 mm) pipe. However, window areaways exceeding ten (10) square feet (0.9 m<sup>2</sup>) in area shall be handled in the manner provided for entrance areaways (see Section 1101.7).

**1101.9 Filling Stations and Motor Vehicle Washing Establishments.** Public filling stations and motor vehicle washing establishments shall have the paved area sloped toward sumps or gratings within the property lines. Curbs not less than six (6) inches (152 mm) high shall be placed where required to direct water to gratings or sumps.

**1101.10 Paved Areas.** Where the occupant creates surface water drainage, the sumps, gratings, or floor drains shall be piped to a storm drain or an approved water course.

**1101.11 Roof Drainage.**

**1101.11.1 Primary Roof Drainage.** Roof areas of a building shall be drained by roof drains or gutters. The location and sizing of drains and gutters shall be coordinated with the structural design and pitch of the roof. Unless otherwise required by the Authority Having Jurisdiction, roof drains, gutters, vertical conductors or leaders, and horizontal storm drains for primary drainage shall be sized based on a storm of sixty (60) minutes duration and 100-year return period.

**1101.11.2 Secondary Roof Drainage.**

**1101.11.2.1** Where parapet walls or other construction extends above the roof and creates areas where storm water would become trapped if the primary roof drainage

system failed to provide sufficient drainage, an independent secondary roof drainage system consisting of scuppers, standpipes, or roof drains shall be provided. Secondary roof drainage systems shall be sized in accordance with Section 1101.11.1 of this code. Overflow drains shall be the same size as the roof drains with the inlet flow line two (2) inches (51 mm) above the low point of the roof and shall be installed independent from the roof drains.

**1101.11.2.2** Where secondary roof drainage is provided by means of roof drains or standpipes, the secondary system shall be separate from the primary system and shall discharge independently at grade or other approved point of discharge.

**1101.11.2.3** Where secondary roof drainage is provided, the overflow level(s) into the secondary system shall be determined by the structural design of the roof, including roof deflection, at a level not less than two (2) inches (51 mm) above the level of the primary drain. An allowance shall be made to account for the required overflow head of water above the secondary inlets. The elevation of the secondary inlet plus the required overflow head shall not exceed the maximum allowable water level on the roof.

**1101.11.2.4** Scuppers shall be sized as rectangular weirs, using hydraulic principles to determine the required length and resulting overflow head. Secondary roof drains and standpipes shall be sized according to Table 11-1. Where standpipes are used, the head allowance required under Section 1101.11.2.3 shall be not less than one and one-half (1-1/2) inches (38 mm).

**1101.11.3 Equivalent Systems.** When approved by the Authority Having Jurisdiction, the requirements of Sections 1101.11.1 and 1101.11.2 shall not preclude the installation of an engineered roof drainage system that has sufficient capacity to prevent water from ponding on the roof in excess of that allowed in the roof structural design with a rainfall rate of at least twice that for a 100-year, 60-minute storm and with a blockage in any single point in the storm drainage system.

**1101.12 Cleanouts.**

**1101.12.1** Cleanouts for building storm drains shall comply with the requirements of Section 719.0 of this code.

**1101.12.2** Rain leaders and conductors connected to a building storm sewer shall have a cleanout installed at the base of the outside leader or outside conductor before it connects to the horizontal drain.

**1101.13** All rainwater sumps serving “public use” occupancy buildings shall be provided with dual pumps arranged to function alternately in case of overload or mechanical failure.

## **1102.0 Materials.**

### **1102.1 Conductors.**

**1102.1.1** Conductors installed above ground in buildings shall be constructed of materials specified in Table 14-1.

**1102.1.2** The inside of conductors installed above ground level shall be of seamless copper water tube, Type K, L, or M; Schedule 40 copper pipe or Schedule 40 copper alloy pipe; Type DWV copper drainage tube; service weight cast-iron soil pipe or hubless cast-iron soil pipe; standard weight galvanized steel pipe; or Schedule 40 ABS or Schedule 40 PVC plastic pipe.

### **1102.2 Leaders.**

**1102.2.1** Leaders shall be constructed of materials specified in Table 14-1.

**1102.2.2** Leaders shall be of seamless copper water tube, Type K, L, or M; Schedule 40 copper pipe; Schedule 40 copper alloy pipe; type DWV copper drainage tube; service weight cast-iron soil pipe or hubless cast-iron soil pipe; aluminum sheet metal, galvanized steel sheet metal or copper sheet metal; standard weight galvanized steel pipe; Class DL or XL lead pipe; or Schedule 40 ABS or Schedule 40 PVC plastic pipe.

**1102.3 Underground Building Storm Drains.** All underground building storm drains shall be constructed of materials specified in Table 14-1.

**1102.4 Building Storm Sewers.** Building storm sewers shall be constructed of materials specified in Table 14-1.

### **1102.5 Subsoil Drains.**

**1102.5.1** Subsoil drains shall be constructed of materials specified in Table 14-1.

**1102.5.2** Subsoil drains shall be open-jointed or of perforated pipe, vitrified clay, plastic, cast iron, or porous concrete.

## **1103.0 Traps on Storm Drains and Leaders.**

**1103.1 Where Required.** Leaders and storm drains, when connected to a combined sewer, shall be trapped. Floor and area drains connected to a storm drain shall be trapped.

**Exception:** Traps shall not be required where roof drains, rain leaders, and other inlets are at locations allowed under Section 906.0, Vent Termination.

**1103.2 Where Not Required.** No trap shall be required for leaders or conductors which are connected to a sewer carrying storm water exclusively.

**1103.3 Trap Size.** Traps, when installed for individual conductors, shall be the same size as the horizontal drain to which they are connected.

**1103.4 Method of Installation of Combined Sewer.** Individual storm-water traps shall be installed on the storm-water drain branch serving each storm-water inlet, or a single trap shall be installed in the main storm drain just before its connection with the combined building sewer. Such traps shall be provided with an accessible cleanout on the outlet side of the trap.

## **1104.0 Leaders, Conductors, and Connections.**

**1104.1 Improper Use.** Leaders or conductors shall not be used as soil, waste, or vent pipes nor shall soil, waste, or vent pipes be used as leaders or conductors.

**1104.2 Protection of Leaders.** Leaders installed along alleyways, driveways, or other locations where they may be exposed to damage shall be protected by metal guards, recessed into the wall, or constructed from ferrous pipe.

**1104.3 Combining Storm with Sanitary Drainage.** The sanitary and storm drainage system of a building shall be entirely separate, except where a combined sewer is used, in which case the building storm drain shall be connected in the same horizontal plane through single wye fittings to the combined building sewer at least ten (10) feet (3048 mm) downstream from any soil stack.

## **1105.0 Roof Drains.**

### **1105.1 Material.**

**1105.1.1** Roof drains shall be constructed of materials specified in Table 14-1.

**1105.1.2** Roof drains shall be of cast iron, copper or copper alloy, lead, or plastic.

**TABLE 11-1**  
**Sizing Roof Drains, Leaders, and Vertical Rainwater Piping**

Size of Drain, Leader or Pipe, Inches	Flow, gpm	Maximum Allowable Horizontal Projected Roof Areas Square Feet at Various Rainfall Rates					
		1 in./h	2 in./h	3 in./h	4 in./h	5 in./h	6 in./h
2	23	2176	1088	725	544	435	363
3	67	6440	3220	2147	1610	1288	1073
4	144	13,840	6920	4613	3460	2768	2307
5	261	25,120	12,560	8373	6280	5024	4187
6	424	40,800	20,400	13,600	10,200	8160	6800
8	913	88,000	44,000	29,333	22,000	17,600	14,667

**TABLE 11-1 (Metric)**  
**Sizing Roof Drains, Leaders, and Vertical Rainwater Piping**

Size of Drain Leader or Pipe, mm	Flow, L/s	Maximum Allowable Horizontal Projected Roof Areas Square Meters at Various Rainfall Rates					
		25 mm/h	50 mm/h	75 mm/h	100 mm/h	125 mm/h	150 mm/h
50	1.5	202	101	67	51	40	34
80	4.2	600	300	200	150	120	100
100	9.1	1286	643	429	321	257	214
125	16.5	2334	1117	778	583	467	389
150	26.8	3790	1895	1263	948	758	632
200	57.6	8175	4088	2725	2044	1635	1363

**Notes:**

1. The sizing data for vertical conductors, leaders, and drains are based on the pipes flowing 7/24 full.
2. For rainfall rates other than those listed, determine the allowable roof area by dividing the area given in the 1 inch/hour (25 mm/hour) column by the desired rainfall rate.
3. Vertical piping may be round, square, or rectangular. Square pipe shall be sized to enclose its equivalent round pipe. Rectangular pipe shall have at least the same cross-sectional area as its equivalent round pipe, except that the ratio of its side dimensions shall not exceed 3 to 1.

**TABLE 11-2**  
**Sizing of Horizontal Rainwater Piping**

Size of Pipe, Inches	Flow at 1/8 in./ft. Slope, gpm	Maximum Allowable Horizontal Projected Roof Areas Square Feet at Various Rainfall Rates					
		1 in./h	2 in./h	3 in./h	4 in./h	5 in./h	6 in./h
3	34	3288	1644	1096	822	657	548
4	78	7520	3760	2506	1880	1504	1253
5	139	13,360	6680	4453	3340	2672	2227
6	222	21,400	10,700	7133	5350	4280	3566
8	478	46,000	23,000	15,330	11,500	9200	7670
10	860	82,800	41,400	27,600	20,700	16,580	13,800
12	1384	133,200	66,600	44,400	33,300	26,650	22,200
15	2473	238,000	119,000	79,333	59,500	47,600	39,650

Size of Pipe, Inches	Flow at 1/4 in./ft. Slope, gpm	Maximum Allowable Horizontal Projected Roof Areas Square Feet at Various Rainfall Rates					
		1 in./h	2 in./h	3 in./h	4 in./h	5 in./h	6 in./h
3	48	4640	2320	1546	1160	928	773
4	110	10,600	5300	3533	2650	2120	1766
5	196	18,880	9440	6293	4720	3776	3146
6	314	30,200	15,100	10,066	7550	6040	5033
8	677	65,200	32,600	21,733	16,300	13,040	10,866
10	1214	116,800	58,400	38,950	29,200	23,350	19,450
12	1953	188,000	94,000	62,600	47,000	37,600	31,350
15	3491	336,000	168,000	112,000	84,000	67,250	56,000

Size of Pipe, Inches	Flow at 1/2 in./ft. Slope, gpm	Maximum Allowable Horizontal Projected Roof Areas Square Feet at Various Rainfall Rates					
		1 in./h	2 in./h	3 in./h	4 in./h	5 in./h	6 in./h
3	68	6576	3288	2192	1644	1310	1096
4	156	15,040	7520	5010	3760	3010	2500
5	278	26,720	13,360	8900	6680	5320	4450
6	445	42,800	21,400	14,267	10,700	8580	7140
8	956	92,000	46,000	30,650	23,000	18,400	15,320
10	1721	165,600	82,800	55,200	41,400	33,150	27,600
12	2768	266,400	133,200	88,800	66,600	53,200	44,400
15	4946	476,000	238,000	158,700	119,000	95,200	79,300

**Notes:**

1. The sizing data for horizontal piping are based on the pipes flowing full.
2. For rainfall rates other than those listed, determine the allowable roof area by dividing the area given in the 1 inch/hour (25 mm/hour) column by the desired rainfall rate.



**TABLE 11-2 (Metric)**  
**Sizing of Horizontal Rainwater Piping**

Size of Pipe, mm	Flow at 10 mm/m Slope, L/s	Maximum Allowable Horizontal Projected Roof Areas Square Meters at Various Rainfall Rates					
		25 mm/h	50 mm/h	75 mm/h	100 mm/h	125 mm/h	150 mm/h
80	2.1	305	153	102	76	61	51
100	4.9	700	350	233	175	140	116
125	8.8	1241	621	414	310	248	207
150	14.0	1988	994	663	497	398	331
200	30.2	4273	2137	1424	1068	855	713
250	54.3	7692	3846	2564	1923	1540	1282
300	87.3	12,375	6187	4125	3094	2476	2062
375	156.0	22,110	11,055	7370	5528	4422	3683

Size of Pipe, mm	Flow at 20 mm/m Slope, L/s	Maximum Allowable Horizontal Projected Roof Areas Square Meters at Various Rainfall Rates					
		25 mm/h	50 mm/h	75 mm/h	100 mm/h	125 mm/h	150 mm/h
80	3.0	431	216	144	108	86	72
100	6.9	985	492	328	246	197	164
125	12.4	1754	877	585	438	351	292
150	19.8	2806	1403	935	701	561	468
200	42.7	6057	3029	2019	1514	1211	1009
250	76.6	10,851	5425	3618	2713	2169	1807
300	123.2	17,465	8733	5816	4366	3493	2912
375	220.2	31,214	15,607	10,405	7804	6248	5202

Size of Pipe, mm	Flow at 40 mm/m Slope, L/s	Maximum Allowable Horizontal Projected Roof Areas Square Meters at Various Rainfall Rates					
		25 mm/h	50 mm/h	75 mm/h	100 mm/h	125 mm/h	150 mm/h
80	4.3	611	305	204	153	122	102
100	9.8	1400	700	465	350	280	232
125	17.5	2482	1241	827	621	494	413
150	28.1	3976	1988	1325	994	797	663
200	60.3	8547	4273	2847	2137	1709	1423
250	108.6	15,390	7695	5128	3846	3080	2564
300	174.6	24,749	12,374	8250	6187	4942	4125
375	312.0	44,220	22,110	14,753	11,055	8853	7367

**Notes:**

1. The sizing data for horizontal piping are based on the pipes flowing full.
2. For rainfall rates other than those listed, determine the allowable roof area by dividing the area given in the 1 inch/hour (25 mm/hour) column by the desired rainfall rate.

**TABLE 11-3  
Size of Gutters**

Diameter of Gutter in Inches	Maximum Rainfall in Inches per Hour				
	1/16 in./ft. Slope	2	3	4	5
3	340	226	170	136	113
4	720	480	360	288	240
5	1250	834	625	500	416
6	1920	1280	960	768	640
7	2760	1840	1380	1100	918
8	3980	2655	1990	1590	1325
10	7200	4800	3600	2880	2400

Diameter of Gutter in Inches	Maximum Rainfall in Inches per Hour				
	1/8 in./ft. Slope	2	3	4	5
3	480	320	240	192	160
4	1020	681	510	408	340
5	1760	1172	880	704	587
6	2720	1815	1360	1085	905
7	3900	2600	1950	1560	1300
8	5600	3740	2800	2240	1870
10	10,200	6800	5100	4080	3400

Diameter of Gutter in Inches	Maximum Rainfall in Inches per Hour				
	1/4 in./ft. Slope	2	3	4	5
3	680	454	340	272	226
4	1440	960	720	576	480
5	2500	1668	1250	1000	834
6	3840	2560	1920	1536	1280
7	5520	3680	2760	2205	1840
8	7960	5310	3980	3180	2655
10	14,400	9600	7200	5750	4800

Diameter of Gutter in Inches	Maximum Rainfall in Inches per Hour				
	1/2 in./ft. Slope	2	3	4	5
3	960	640	480	384	320
4	2040	1360	1020	816	680
5	3540	2360	1770	1415	1180
6	5540	3695	2770	2220	1850
7	7800	5200	3900	3120	2600
8	11,200	7460	5600	4480	3730
10	20,000	13,330	10,000	8000	6660

**TABLE 11-3 (Metric)**  
**Size of Gutters**

Diameter of Gutter in mm	Maximum Rainfall in Millimeters per Hour				
	<b>50.8</b>	<b>76.2</b>	<b>101.6</b>	<b>127.0</b>	<b>152.4</b>
<b>5.2 mm/m Slope</b>					
80	31.6	21.0	15.8	12.6	10.5
100	66.9	44.6	33.4	26.8	22.3
125	116.1	77.5	58.1	46.5	38.7
150	178.4	119.1	89.2	71.4	59.5
175	256.4	170.9	128.2	102.2	85.3
200	369.7	246.7	184.9	147.7	123.1
250	668.9	445.9	334.4	267.6	223.0

Diameter of Gutter in mm	Maximum Rainfall in Millimeters per Hour				
	<b>50.8</b>	<b>76.2</b>	<b>101.6</b>	<b>127.0</b>	<b>152.4</b>
<b>10.4 mm/m Slope</b>					
80	44.6	29.7	22.3	17.8	14.9
100	94.8	63.3	47.4	37.9	31.6
125	163.5	108.9	81.8	65.4	54.5
150	252.7	168.6	126.3	100.8	84.1
175	362.3	241.5	181.2	144.9	120.8
200	520.2	347.5	260.1	208.1	173.7
250	947.6	631.7	473.8	379	315.9

Diameter of Gutter in mm	Maximum Rainfall in Millimeters per Hour				
	<b>50.8</b>	<b>76.2</b>	<b>101.6</b>	<b>127.0</b>	<b>152.4</b>
<b>20.9 mm/m Slope</b>					
80	63.2	42.2	31.6	25.3	21.0
100	133.8	89.2	66.9	53.5	44.6
125	232.3	155.0	116.1	92.9	77.5
150	356.7	237.8	178.4	142.7	118.9
175	512.8	341.9	256.4	204.9	170.9
200	739.5	493.3	369.7	295.4	246.7
250	133.8	891.8	668.9	534.2	445.9

Diameter of Gutter in mm	Maximum Rainfall in Millimeters per Hour				
	<b>50.8</b>	<b>76.2</b>	<b>101.6</b>	<b>127.0</b>	<b>152.4</b>
<b>41.7 mm/m Slope</b>					
80	89.2	59.5	44.6	35.7	29.7
100	189.5	126.3	94.8	75.8	63.2
125	328.9	219.2	164.4	131.5	109.6
150	514.7	343.3	257.3	206.2	171.9
175	724.6	483.1	362.3	289.9	241.4
200	1040.5	693.0	520.2	416.2	346.5
250	1858.0	1238.4	929.0	743.2	618.7

**1105.2 Dome or Strainer for General Use.** All roof drains and overflow drains, except those draining to hanging gutters, shall be equipped with strainers extending not less than four (4) inches (102 mm) above the surface of the roof immediately adjacent to the drain. Strainers shall have a minimum inlet area above the roof level of not less than one and one-half (1-1/2) times the area of the conductor or leader to which the drain is connected.

**1105.3 Strainers for Flat Decks.** Roof drain strainers for use on sun decks, parking decks, and similar areas which are normally serviced and maintained may be of the flat surface type. Such roof drain strainers shall be level with the deck and shall have an available inlet area of no less than two (2) times the area of the conductor or leader to which the drain is connected.

**1105.4 Roof Drain Flashings.** Connection between the roof and roof drains which pass through the roof and into the interior of the building shall be made watertight by the use of proper flashing material.

**1105.4.1** Where lead flashing material is used, it shall be a minimum of four (4) pounds per square foot (19.5 kg/m<sup>2</sup>).

**1105.4.2** Where copper flashing material is used, it shall be a minimum of twelve (12) ounces per square foot (3.7 kg/m<sup>2</sup>).

**1106.0 Size of Leaders, Conductors, and Storm Drains.**

**1106.1 Vertical Conductors and Leaders.** Vertical conductors and leaders shall be sized on the basis of the maximum projected roof area and Table 11-1.

**1106.2 Size of Horizontal Storm Drains and Sewers.** The size of building storm drains or building storm sewers or any of their horizontal branches shall be based upon the maximum projected roof or paved area to be handled and Table 11-2.

**1106.3 Size of Roof Gutters.** The size of semicircular gutters shall be based on the maximum projected roof area and Table 11-3.

**1106.4 Side Walls Draining onto a Roof.** Where vertical walls project above a roof so as to permit storm water to drain to the roof area below, the adjacent roof area may be computed from Table 11-1 as follows:

- (1) For one (1) wall – add fifty (50) percent of the wall area to the roof area figures.
- (2) For two (2) adjacent walls – add thirty-five (35) percent of the total wall areas.
- (3) Two (2) walls opposite of same height – add no additional area.
- (4) Two (2) walls opposite of differing heights –

add fifty (50) percent of wall area above top of lower wall.

- (5) Walls on three (3) sides – add fifty (50) percent of area of the inner wall below the top of the lowest wall, plus allowance for the area of wall above top of lowest wall, per (2) and (4) above.
- (6) Walls on four (4) sides – no allowance for wall areas below top of lowest wall – add for areas above the top of the lowest wall per (1), (2), (4), and (5) above.

**1107.0 Values for Continuous Flow.**

Where there is a continuous or semi-continuous discharge into the building storm drain or building storm sewer, as from a pump, ejector, air-conditioning plant, or similar device, one (1) gpm (3.8 L/min.) of such discharge shall be computed as being equivalent to twenty-four (24) square feet (2.2 m<sup>2</sup>) of roof area, based upon a rate of rainfall of four (4) inches (102 mm) per hour.

**1108.0 Controlled-Flow Roof Drainage.**

**1108.1 Application.** In lieu of sizing the storm drainage system in accordance with Section 1106.0, the roof drainage may be sized on the basis of controlled flow and storage of the storm water on the roof, provided the following conditions are met:

- (1) The water from a 25-year-frequency storm shall not be stored on the roof for more than twenty-four (24) hours.
- (2) During the storm, the water depth on the roof shall not exceed the depths specified in Table 11-4.

**TABLE 11-4  
Controlled-Flow Maximum Roof Water Depth**

Roof Rise,*		Max Water Depth at Drain,	
Inches	(mm)	Inches	(mm)
Flat	(Flat)	3	(76)
2	(51)	4	(102)
4	(102)	5	(127)
6	(152)	6	(152)

\*Vertical measurement from the roof surface at the drain to the highest point of the roof surface served by the drain, ignoring any local depression immediately adjacent to the drain.

- (3) No less than two (2) drains shall be installed in roof areas of ten thousand (10,000) square feet (929.0 m<sup>2</sup>) or less, and no less than one (1) additional drain shall be installed for each ten thousand (10,000) square feet (929.0 m<sup>2</sup>) of roof area over ten thousand (10,000) square feet (929.0 m<sup>2</sup>).
- (4) Each roof drain shall have a pre-calibrated, fixed (non-adjustable), and proportional weir (notched) in a standing water collar inside the strainer. No mechanical devices or valves shall be allowed.
- (5) Pipe sizing shall be based on the precalibrated rate of flow (gpm) of the pre-calibrated weir for the maximum allowable water depth, and Tables 11-1 and 11-2.
- (6) The height of stones or other granular material above the waterproofed surface shall not be considered in water depth measurement, and the roof surface in the vicinity of the drain shall not be recessed to create a reservoir.
- (7) Roof design, where controlled-flow roof drainage is used, shall be such that the minimum design roof live load is thirty (30) pounds per square foot (146.5 kg/m<sup>2</sup>) to provide a safety factor above the fifteen (15) pounds per square foot (73.2 kg/m<sup>2</sup>) represented by the depth of water stored on the roof as indicated in Table 11-4.
- (8) Scuppers shall be provided in parapet walls. The distance of scupper bottoms above the roof level at the drains shall not exceed the maximum distances specified in Table 11-5.
- (9) Scupper openings shall be a maximum of one (1) inch (25.4 mm) high. A sufficient number of scuppers shall be provided so that the total scupper cross-sectional area is at least equal to that required for horizontal storm drains in Table 11-2 (column for half (1/2) inch (12.7 mm) slope).
- (10) Flashings shall extend above the top of the scuppers.
- (11) At any wall or parapet, forty-five (45) degree (0.79 rad) cants shall be installed.
- (12) Separate storm and sanitary drainage systems shall be provided within the building.
- (13) Calculations for the roof drainage system shall be submitted along with the plans to the Authority Having Jurisdiction for approval.

**1108.2 Setback Roofs.** Drains on setback roofs may be connected to the controlled-flow drainage systems provided:

- (1) The setback is designed for storing water, or
- (2) The square footage of the setback drainage area is converted as outlined in Section 1108.0 to gpm, and the storm-water pipe sizes in the controlled-flow system are based on the sum of the loads.
- (3) The branch from each of the roof drains that are not provided with controlled flow shall be sized in accordance with Table 11-1.

**1109.0 Testing.**

**1109.1 Testing Required.** New building storm drainage systems and parts of existing systems that have been altered, extended, or repaired shall be tested as described in Section 1109.2.1 to disclose leaks and defects.

**1109.2 Methods of Testing Storm Drainage Systems.** Except for outside leaders and perforated or open-jointed drain tile, the piping of storm drain systems shall be tested upon completion of the rough piping installation by water or air, and proved tight. The Authority Having Jurisdiction may require the removal of any cleanout plugs to ascertain whether the pressure has reached all parts of the system. Either of the following test methods shall be used:

**1109.2.1 Water Test.** After piping has been installed, the water test shall be applied to the drainage system, either to the entire system or to sections. If the test is applied to the entire system, all openings in the piping shall be tightly closed except for the highest opening, and the system shall be filled with water to the

**TABLE 11-5**

**Distance of Scupper Bottoms Above Roof**

Roof Rise,*		Maximum Distance of Scupper Bottom	
		Above Roof Level at Drains,	
Inches	(mm)	Inches	(mm)
Flat	(Flat)	3	(76.2)
2	(51)	4	(102.0)
4	(102)	5	(127.0)
6	(152)	6	(152.0)

\*Vertical measurement from the roof surface at the drain to the highest point of the roof surface served by the drain, ignoring any local depression immediately adjacent to the drain.

point of overflow. If the system is tested in sections, each opening shall be tightly plugged except for the highest opening of the section under test, and each section shall be filled with water, but no section shall be tested with less than a ten (10) feet (3048 mm) head of water. In testing successive sections, at least the upper ten (10) feet (3048 mm) of the next preceding section shall be tested so that no joint of pipe in the building (except the uppermost ten (10) feet (3048 mm) of a roof drainage system, which shall be filled with water to the flood level of the uppermost roof drain) shall have been submitted to a test of less than a ten (10) feet (3048 mm) head of water. The water shall be kept in the system or in the portion under test for at least fifteen (15) minutes before inspection starts; the system shall then be tight at all points.

**1109.2.2 Air Test.** The air test shall be made by attaching an air compressor testing apparatus to any suitable opening after closing all other inlets and outlets to the system, forcing air into the system until there is a uniform gauge pressure of five (5) psi (34.5 kPa) or sufficient to balance a column of mercury ten (10) inches (254 mm) in height. This pressure shall be held without introduction of additional air for a period of at least fifteen (15) minutes. Schedule 40 plastic DWV systems shall not be tested by the air test method.

**1109.2.3 Exceptions.** When circumstances exist that make air and water tests described in Sections 1109.2.1 and 1109.2.2 above impractical, and for minor maintenance, repairs and installations, the Authority Having Jurisdiction may perform the inspection as considered advisable by said authority to ensure that the work has been in accordance with provisions of this code.



## CHAPTER 12

### FUEL PIPING

#### 1201.0 Scope of Gas Piping.

- (A) Coverage of piping systems shall extend from the point of delivery to the connections with each gas utilization device. For other than undiluted liquefied petroleum gas systems, the point of delivery shall be considered the outlet of the service meter assembly or the outlet of the service regulator or service shutoff valve where no meter is provided. For undiluted liquefied petroleum gas systems, the point of delivery shall be considered the outlet of the final pressure regulator, exclusive of the line gas regulators, in the system.
- (B) Piping systems requirements shall include design, materials, components, fabrications, assembly, installation, testing inspection, operation, and maintenance.
- (C) This code shall not apply to the following (reference standards for some of which appear in Appendix L [NFPA 54:1.1.1.2]):
- (1) Portable LP-Gas equipment of all types that are not connected to a fixed fuel piping system
  - (2) Installation of farm equipment such as brooders, dehydrators, dryers, and irrigation equipment
  - (3) Raw material (feedstock) applications except for piping to special atmosphere generators
  - (4) Oxygen-fuel gas cutting and welding systems
  - (5) Industrial gas applications using gases such as acetylene and acetylenic compounds, hydrogen, ammonia, carbon monoxide, oxygen, and nitrogen
  - (6) Petroleum refineries, pipeline compressor or pumping stations, loading terminals, compounding plants, refinery tank farms, and natural gas processing plants
  - (7) Large integrated chemical plants or portions of such plants where flammable or combustible liquids or gases are produced by chemical reactions or used in chemical reactions
  - (8) LP-Gas installations at utility gas plants
  - (9) Liquefied natural gas (LNG) installations
  - (10) Fuel gas piping in power and atomic energy plants
  - (11) Proprietary items of equipment, apparatus, or instruments such as gas-generating sets, compressors, and calorimeters
  - (12) LP-Gas equipment for vaporization, gas mixing, and gas manufacturing
  - (13) LP-Gas piping for buildings under construction or renovations that are not to become part of the permanent building piping system—that is, temporary fixed piping for building heat
  - (14) Installation of LP-Gas systems for railroad switch heating
  - (15) Installation of LP-Gas and compressed natural gas systems on vehicles
  - (16) Gas piping, meters, gas-pressure regulators, and other appurtenances used by the serving gas supplier in distribution of gas, other than undiluted LP-Gas [NFPA 54: 1.1.1.2]

#### 1202.0 General.

The regulations of this chapter shall govern the installation of all fuel gas piping in or in connection with any building or structure or within the property lines of any premises up to 5 psi, other than service pipe. Fuel oil piping systems shall be installed in accordance with NFPA 31.

**Except for:** Gas piping, meters, gas-pressure regulators, and other appurtenances used by the serving gas supplier in distribution of gas, other than undiluted LP-Gas [NFPA 54: 1.1.1.2]

#### 1203.0 Definitions.

For the purposes of this code, these definitions shall apply to this chapter. Certain terms, phrases, words, and their derivatives shall be interpreted as set forth in this section, provided, however, that whenever the words “gas meters” appear, they shall be construed to also mean valves and those devices required for the regulation of pressure and the measurement of



natural gas being dispensed for any building, structure, or premises.

**1203.1 Appliance Fuel Connector** – An assembly of listed semi-rigid or flexible tubing and fittings to carry fuel between a fuel-piping outlet and a fuel-burning appliance.

**1203.2 Fuel Gas** – Natural, manufactured, liquefied petroleum, or a mixture of these.

**1203.3 Gas Piping** – Any installation of pipe, valves, or fittings that is used to convey fuel gas, installed on any premises or in any building, but shall not include:

- (1) Any portion of the service piping.
- (2) Any approved piping connection six (6) feet (1829 mm) or less in length between an existing gas outlet and a gas appliance in the same room with the outlet.

**1203.4 Gas-Piping System** – Any arrangement of gas piping supplied by one (1) meter and each arrangement of gas piping serving a building, structure, or premises, whether individually metered or not.

**1203.5 Liquefied Petroleum Gas (LPG) Facilities** – Liquefied petroleum gas (LPG) facilities means tanks, containers, container valves, regulating equipment, meters, and/or appurtenances for the storage and supply of liquefied petroleum gas for any building, structure, or premises.

**1203.6 Provision for Location of Point of Delivery** – The location of the point of delivery shall be acceptable to the serving gas supplier. [NFPA 54:5.2]

**1203.7 Quick-Disconnect Device** – A hand-operated device which provides a means for connecting and disconnecting an appliance or an appliance connector to a gas supply and which is equipped with an automatic means to shut off the gas supply when the device is disconnected.

**1203.8 Service Piping** – The piping and equipment between the street gas main and the gas piping system inlet which is installed by and is under the control and maintenance of the serving gas supplier.

**1203.9 Transition Gas Riser** – Any listed or approved section or sections of pipe and fittings used to convey fuel gas and installed in a gas piping system for the purpose of providing a transition from below ground to above ground.

#### **1204.0 Inspection.**

**1204.1** Upon completion of the installation, alteration, or repair of any gas piping, and prior to the use thereof, the Authority Having Jurisdiction shall be notified that such gas piping is ready for inspection.

**1204.2** All excavations required for the installation of underground piping shall be kept open until such time as the piping has been inspected and approved. If any such piping is covered or concealed before such approval, it shall be exposed upon the direction of the Authority Having Jurisdiction.

**1204.3** The Authority Having Jurisdiction shall make the following inspections and either shall approve that portion of the work as completed or shall notify the permit holder wherein the same fails to comply with this code.

##### **1204.3.1 Rough Piping Inspection.**

This inspection shall be made after all gas piping authorized by the permit has been installed and before any such piping has been covered or concealed or any fixture or appliance has been attached thereto. This inspection shall include a determination that the gas-piping size, material, and installation meet the requirements of this code.

##### **1204.3.2 Final Piping Inspection.**

This inspection shall be made after all piping authorized by the permit has been installed and after all portions thereof which are to be covered or concealed are so concealed and before any fixtures, appliance, or shutoff valve has been attached thereto. This inspection shall be in accordance with Section 1214.1. Test gauges used in conducting tests shall comply with Section 319.0, Test Gauges.

**1204.4** In cases where the work authorized by the permit consists of a minor installation of additional piping to piping already connected to a gas meter, the foregoing inspections may be waived at the discretion of the Authority Having Jurisdiction. In this event, the Authority Having Jurisdiction shall make such inspection as deemed advisable in order to be assured that the work has been performed in accordance with the intent of this code.

#### **1205.0 Certificate of Inspection.**

**1205.1** If, upon final piping inspection, the installation is found to comply with the provisions of this code, a certificate of inspection may be issued by the Authority Having Jurisdiction.

**1205.2** A copy of the certificate of such final piping inspection shall be issued to the serving gas supplier supplying gas to the premises.

**1205.3** It shall be unlawful for any serving gas supplier, or person furnishing gas, to turn on or cause to be turned on, any fuel gas or any gas meter or meters, until such certificate of final inspection, as herein provided, has been issued.

**1206.0 Authority to Render Gas Service.**

**1206.1** It shall be unlawful for any person, firm, or corporation, excepting an authorized agent or employee of a person, firm, or corporation engaged in the business of furnishing or supplying gas and whose service pipes supply or connect with the particular premises, to turn on or reconnect gas service in or on any premises where and when gas service is, at the time, not being rendered.

**1206.2** It shall be unlawful to turn on or connect gas in or on any premises unless all outlets are properly and securely connected to gas appliances or capped or plugged with screw joint fittings.

**1207.0 Authority to Disconnect.**

**1207.1** The Authority Having Jurisdiction or the serving gas supplier is hereby authorized to disconnect any gas piping or appliance or both which shall be found not to conform to the requirements of this code or which may be found defective and in such condition as to endanger life or property.

**1207.2** Where such disconnection has been made, a notice shall be attached to such gas piping or appliance or both which shall state the same has been disconnected, together with the reasons therefor.

**1207.3** It shall be unlawful to remove or disconnect any gas piping or gas appliance without capping or plugging with a screw joint fitting the outlet from which said pipe or appliance was removed. All outlets to which gas appliances are not connected shall be left capped gastight on any piping system which has been installed, altered, or repaired.

**Exception:** When an approved listed quick disconnect device is used.

**1208.0 Temporary Use of Gas.**

Where temporary use of gas is desired and the Authority Having Jurisdiction deems the use necessary, a permit may be issued for such use for a period of time not to exceed that designated by the Authority Having Jurisdiction, provided that such gas-piping system otherwise conforms to the requirements of this code regarding material, sizing, and safety.

**1209.0 Gas-Piping System Design, Materials, and Components.****1209.1 Piping Plan.**

**1209.1.1 Installation of Piping System.** Where required by the Authority Having Jurisdiction, a piping sketch or plan shall be prepared before proceeding with the installation. This plan shall

show the proposed location of piping, the size of different branches, the various load demands, and the location of the point of delivery.

**1209.1.2 Addition to Existing System.** When additional gas utilization equipment is being connected to a gas-piping system, the existing piping shall be checked to determine whether it has adequate capacity (see section 1209.4.3). If inadequate, the existing system shall be enlarged as required, or separate gas piping of adequate capacity shall be provided.

**1209.2 Provision for Location of Point of Delivery.** The location of the point of delivery shall be acceptable to the serving gas supplier.

**1209.3 Interconnections Between Gas-Piping Systems.**

**1209.3.1 Interconnections Supplying Separate Users.** Where two or more meters, or two or more service regulators where meters are not provided, are located on the same premises and supply separate users, the gas piping systems shall not be interconnected on the outlet side of the meters or service regulators.

**1209.3.2 Interconnections for Standby Fuels.** Where a supplementary gas for standby use is connected downstream from a meter or a service regulator where a meter is not provided, a device to prevent backflow shall be installed. A three-way valve installed to admit the standby supply and at the same time shut off the regular supply shall be permitted to be used for this purpose.

**1209.4 Sizing of Gas-Piping Systems.**

**1209.4.1 General Considerations.** Gas-piping systems shall be of such size and so installed as to provide a supply of gas sufficient to meet the maximum demand without undue loss of pressure between the point of delivery and the gas utilization equipment.

**1209.4.2 Maximum Gas Demand.** The volume of gas to be provided (in cubic feet per hour) shall be determined directly from the manufacturers' input ratings of the gas utilization equipment served. Where the input rating is not indicated, the gas supplier, equipment manufacturer, or a qualified agency shall be contacted or the rating from Table 12-1 shall be used for estimating the volume of gas to be supplied. The total connected hourly load shall be used as the basis for piping sizing, assuming all equipment is operating at full capacity simultaneously.

**Exception:** Sizing shall be permitted to be based upon established load diversity factors.

**TABLE 12-1**  
**Approximate Gas Input for Typical Appliances**

Appliance	Input Btu/h. (Approx.)
<b>Space Heating Units</b>	
Warm air furnace	
Single family	100,000
Multifamily, per unit	60,000
Hydronic boiler	
Single family	100,000
Multifamily, per unit	60,000
<b>Space-and Water-Heating Units</b>	
Hydronic boiler	
Single family	120,000
Multifamily, per unit	75,000
<b>Water-Heating Appliances</b>	
Water heater, automatic storage 30 to 40 gal tank	35,000
Water heater, automatic storage 50 gal tank	50,000
Water heater, automatic instantaneous	
Capacity at 2 gal/minute	142,800
Capacity at 4 gal/minute	285,000
Capacity at 6 gal/minute	428,400
Water heater, domestic, circulating or side-arm	35,000
<b>Cooking Appliances</b>	
Range, freestanding, domestic	65,000
Built-in oven or broiler unit, domestic	25,000
Built-in top unit, domestic	40,000
<b>Other Appliances</b>	
Refrigerator	3,000
Clothes dryer, type 1 (domestic)	35,000
Gas fireplace direct vent	40,000
Gas log	80,000
Barbecue	40,000
Gaslight	2,500

For SI units: 1 Btu per hour = 0.293 W

NFPA 54: Table 5.4.2.1

**1209.4.3 Sizing Methods.** Gas piping shall be sized in accordance with one of the following:

- (1) Pipe sizing tables or sizing equations in this chapter.
- (2) Other approved engineering methods acceptable to the Authority Having Jurisdiction.
- (3) Sizing tables included in a listed piping system manufacturer's installation instructions.

**1209.4.4 Allowable Pressure Drop.** The design pressure loss in any piping system under maximum probable flow conditions, from the point of delivery to the inlet connection of the gas utilization equipment, shall be such that the supply pressure at the equipment is greater than the minimum pressure required for proper equipment operation.

**1209.5 Acceptable Piping Materials and Joining Methods.**

**1209.5.1 General.**

**1209.5.1.1 Materials.** Materials used for piping systems shall comply with the requirements of this chapter or shall be acceptable to the Authority Having Jurisdiction.

**1209.5.1.2 Used Materials.** Pipe, fittings, valves, or other materials shall not be used again unless they are free of foreign materials and have been ascertained to be adequate for the service intended.

**1209.5.1.3 Other Materials.** Material not covered by the standards specifications listed herein shall be investigated and tested to determine that it is safe and suitable for the proposed service and, in addition, shall be recommended for that service by the manufacturer and shall be acceptable to the Authority Having Jurisdiction.

**1209.5.2 Metallic Pipe.**

**1209.5.2.1** Cast-iron pipe shall not be used.

**1209.5.2.2** Steel and wrought-iron pipe shall be at least of standard weight (Schedule 40) and shall comply with one of the following standards:

- (1) ANSI/ASME B36.10, *Welded and Seamless Wrought-Steel Pipe*
- (2) ASTM A 53, *Standard Specification for Pipe, Steel, Black and Hot-Dipped, Zinc-Coated Welded and Seamless*
- (3) ASTM A 106, *Standard Specification for Seamless Carbon Steel Pipe for High-Temperature Service*

**1209.5.2.3** Copper and brass pipe shall not be used if the gas contains more than an average of 0.3 grains of hydrogen sulfide per 100 scf of gas (0.7 mg/100 L).

Threaded copper, brass, or aluminum alloy pipe shall not be used with gases corrosive to such material.

**1209.5.2.4** Aluminum alloy pipe shall comply with ASTM B 241, *Specification for Aluminum-Alloy Seamless Pipe and Seamless Extruded Tube* (except that the use of alloy 5456 is prohibited) and shall be marked at each end of each length indicating compliance. Aluminum alloy pipe shall be coated to protect against external corrosion where it is in contact with masonry, plaster, or insulation or is subject to repeated wettings by such liquids as water, detergents, or sewage. Aluminum alloy pipe shall not be used in exterior locations or underground.

**1209.5.3 Metallic Tubing.** Seamless copper, aluminum alloy, or steel tubing shall not be used with gases corrosive to such material.

**1209.5.3.1** Steel tubing shall comply with ASTM A 539, *Standard Specification for Electric Resistance-Welded Coiled Steel Tubing for Gas and Fuel Oil Lines*, or ASTM A 254, *Standard Specification for Copper Brazed Steel Tubing*.

**1209.5.3.2** Copper and brass tubing shall not be used if the gas contains more than an average of 0.3 g of hydrogen sulfide per 100 scf of gas (0.7 mg/100 L). Copper tubing shall comply with standard Type K or L of ASTM B 88, *Specification for Seamless Copper Water Tube*, or ASTM B 280, *Specification for Seamless Copper Tube for Air-Conditioning and Refrigeration Field Service*.

**1209.5.3.3** Aluminum alloy tubing shall comply with ASTM B 210, *Specification for Aluminum-Alloy Drawn Seamless Tubes*, or ASTM B 241, *Specification for Aluminum Alloy Seamless Pipe and Seamless Extruded Tube*. Aluminum alloy tubing shall be coated to protect against external corrosion where it is in contact with masonry, plaster, or insulation or is subject to repeated wettings by liquids such as water, detergent, or sewage. Aluminum alloy tubing shall not be used in exterior locations or underground.

**1209.5.3.4** Corrugated stainless steel tubing shall be tested and listed in compliance with the construction, installation, and performance

requirements of ANSI/IAS LC-1, *Standard for Fuel Gas Piping Systems Using Corrugated Stainless Steel Tubing*.

**1209.5.4 Plastic Pipe, Tubing, and Fittings.**

Plastic pipe, tubing, and fittings shall be used outside underground only and shall conform with ASTM D 2513, *Standard Specification for Thermoplastic Gas Pressure Pipe, Tubing, and Fittings*. Pipe to be used shall be marked "gas" and "ASTM D 2513."

Anodeless risers shall comply with the following:

**1209.5.4.1** Factory-assembled anodeless risers shall be recommended by the manufacturer for the gas used and shall be leak tested by the manufacturer in accordance with written procedures.

**1209.5.4.2** Service head adapters and field-assembled anodeless risers incorporating service head adapters shall be recommended by the manufacturer for the gas used by the manufacturer and shall be design-certified to meet the requirements of Category I of ASTM D 2513, *Standard Specification for Thermoplastic Gas Pressure Pipe, Tubing, and Fittings*, and the code of Federal Regulations, Title 49, Part 192.281(e). The manufacturer shall provide the user qualified installation instructions as prescribed by the code of Federal Regulations, Title 49, Part 192.283(b).

**1209.5.4.3** The use of plastic pipe, tubing, and fittings in undiluted liquefied petroleum gas-piping systems shall be in accordance with NFPA 58, *Liquefied Petroleum Gas Code*.

**1209.5.5 Workmanship and Defects.** Gas pipe or tubing and fittings shall be clear and free from cutting burrs and defects in structure or threading and shall be thoroughly brushed, and chip and scale blown. Defects in pipe, tubing, and fittings shall not be repaired. Defective pipe, tubing, and fittings shall be replaced.

**1209.5.6 Protective Coating.** Where in contact with material or atmosphere exerting a corrosive action, metallic piping and fittings coated with a corrosion-resistant material shall be used. External or internal coatings or linings used on piping or components shall not be considered as adding strength.

**1209.5.7 Metallic Pipe Threads.**

**(A) Specifications for Pipe Threads.** Metallic pipe and fitting threads shall be taper pipe

threads and shall comply with ANSI/ASME B1.20.1, *Standard for Pipe Threads, General Purpose (Inch)*.

- (B) **Damaged Threads.** Pipe with threads that are stripped, chipped, corroded, or otherwise damaged shall not be used. Where a weld opens during the operation of cutting or threading, that portion of the pipe shall not be used.
- (C) **Number of Threads.** Field threading of metallic pipe shall be in accordance with Table 12-2.
- (D) **Thread Compounds.** Thread (joint) compounds (pipe dope) shall be resistant to the action of liquefied petroleum gas or to any other chemical constituents of the gases to be conducted through the piping.

**TABLE 12-2**  
**Specifications for Threading Metallic Pipe**

Iron Pipe Size (in.)	Approximate Length of Threaded Portion (in.)	Approximate No. of Threads to Be Cut
1/2	3/4	10
3/4	3/4	10
1	7/8	10
1-1/4	1	11
1-1/2	1	11
2	1	11
2-1/2	1-1/2	12
3	1-1/2	12
4	1-5/8	13

For SI units, 1 in. = 25.4 mm.

#### 1209.5.8 Metallic Piping Joints and Fittings.

The type of piping joint used shall be suitable for the pressure-temperature conditions and shall be selected giving consideration to joint tightness and mechanical strength under the service conditions. The joint shall be able to sustain the maximum end force due to the internal pressure and any additional forces due to temperature expansion or contraction, vibration, fatigue, or to the weight of the pipe and its contents.

**1209.5.8.1 Pipe Joints.** Pipe joints shall be threaded, flanged, brazed, or welded. Where nonferrous pipe is brazed, the

brazing materials shall have a melting point in excess of 1000°F (538°C). Brazing alloys shall not contain more than 0.05 percent phosphorus.

**1209.5.8.2 Tubing Joints.** Tubing joints shall either be made with approved gas tubing fittings or be brazed with a material having a melting point in excess of 1000°F (538°C). Brazing alloys shall not contain more than 0.05 percent phosphorus.

**1209.5.8.3 Flared Joints.** Flared joints shall be used only in systems constructed from nonferrous pipe and tubing where experience or tests have demonstrated that the joint is suitable for the conditions and where provisions are made in the design to prevent separation of the joints.

#### 1209.5.8.4 Metallic Fittings (Including Valves, Strainers, Filters).

- (1) Threaded fittings in sizes larger than 4 in. (100 mm) shall not be used unless acceptable to the Authority Having Jurisdiction.
- (2) Fittings used with steel or wrought-iron pipe shall be steel, brass, bronze, malleable iron, or cast iron.
- (3) Fittings used with copper or brass pipe shall be copper, brass, or bronze.
- (4) Fittings used with aluminum alloy pipe shall be of aluminum alloy.
- (5) Cast-Iron Fittings.
  - (a) Flanges shall be permitted.
  - (b) Bushings shall not be used.
  - (c) Fittings shall not be used in systems containing flammable gas-air mixtures.
  - (d) Fittings in sizes 4 in. (100 mm) and larger shall not be used indoors unless approved by the Authority Having Jurisdiction.
  - (e) Fittings in sizes 6 in. (150 mm) and larger shall not be used unless approved by the Authority Having Jurisdiction.
- (6) Aluminum Alloy Fittings. Threads shall not form the joint seal.
- (7) Zinc-Aluminum Alloy Fittings. Fittings shall not be used in systems containing flammable gas-air mixtures.
- (8) Special Fittings. Fittings such as couplings; proprietary-type joints; saddle tees; gland-type compression

fittings, and flared, flareless, or compression-type tubing fittings shall be (1) used within the fitting manufacturers' pressure-temperature recommendations; (2) used within the service conditions anticipated with respect to vibration, fatigue, thermal expansion, or contraction; (3) installed or braced to prevent separation of the joint by gas pressure or external physical damage; and (4) acceptable to the Authority Having Jurisdiction.

#### 1209.5.9 Plastic Piping, Joints, and Fittings.

Plastic pipe, tubing, and fittings shall be joined in accordance with the manufacturers' instructions. The following shall be observed when making such joints:

- (A) The joint shall be designed and installed so that the longitudinal pullout resistance of the joint will be at least equal to the tensile strength of the plastic piping material.
- (B) Heat-fusion joints shall be made in accordance with qualified procedures that have been established and proven by test to produce gastight joints at least as strong as the pipe or tubing being joined. Joints shall be made with the joining method recommended by the pipe manufacturer. Heat-fusion fittings shall be marked "ASTM D 2513."
- (C) Where compression-type mechanical joints are used, the gasket material in the fitting shall be compatible with the plastic piping and with the gas distributed by the system. An internal tubular rigid stiffener shall be used in conjunction with the fitting. The stiffener shall be flush with the end of the pipe or tubing and shall extend at least to the outside end of the pipe or tubing and shall extend at least to the outside end of the compression fitting when installed. The stiffener shall be free of rough or sharp edges and shall not be a force fit in the plastic. Split tubular stiffeners shall not be used.
- (D) Plastic piping joints and fittings for use in liquefied petroleum gas-piping systems shall be in accordance with *Liquefied Petroleum Gas Code*, NFPA 58.

**1209.5.10 Flanges.** All flanges shall comply with ANSI/ASME B16.1, *Standard for Cast Iron Pipe Flanges and Flanged Fittings*; ANSI/ASME B16.20, *Standard for Ring-Joint Gaskets and Grooves for Steel Pipe Flanges*; or MSS SP-6, *Standard Finishes for Contact Faces of Pipe Flanges and Connecting-End Flanges of Valves and Fittings*. The pressure-temperature ratings shall equal or exceed that required by the application.

- (A) **Flange Facings** (Standard facings shall be permitted for use under this code. Where 150-psi (1090 kPa) steel flanges are bolted to Class 125 cast-iron flanges, the raised face on the steel flange shall be removed.
- (B) **Lapped Flanges.** Lapped flanges shall be used only above ground or in exposed locations accessible for inspection.

**1209.5.11 Flange Gaskets.** The material for gaskets shall be capable of withstanding the design temperature and pressure of the piping system and the chemical constituents of the gas being conducted without change to its chemical and physical properties. The effects of fire exposure to the joint shall be considered in choosing the material.

- (1) Acceptable materials include the following:
  - (a) Metal or metal-jacketed asbestos (plain or corrugated)
  - (b) Asbestos
  - (c) Aluminum "O" rings and spiral-wound metal gaskets
- (2) When a flanged joint is opened, the gasket shall be replaced.
- (3) Full-face gaskets shall be used with all bronze and cast-iron flanges.

#### 1209.6 Gas Meters.

**1209.6.1 Capacity.** Gas meters shall be selected for the maximum expected pressure and permissible pressure drop.

#### 1209.6.2 Location.

- (A) Gas meters shall be located in ventilated spaces readily accessible for examination, reading, replacement, or necessary maintenance.
- (B) Gas meters shall not be placed where they will be subjected to damage, such as adjacent to a driveway; under a fire escape; in public passages, halls, or coal bins; or where they will be subject to excessive corrosion or vibration.
- (C) Gas meters shall be located at least 3 ft (0.9 m) from sources of ignition.

(D) Gas meters shall not be located where they will be subjected to extreme temperatures or sudden extreme changes in temperature. Meters shall not be located in areas where they are subjected to temperatures beyond those recommended by the manufacturer.

**1209.6.3 Supports.** Gas meters shall be supported or connected to rigid piping so as not to exert a strain on the meters. Where flexible connectors are used to connect a gas meter to downstream piping at mobile homes in mobile home parks, the meter shall be supported by a post or bracket placed in a firm footing or by other means providing equivalent support.

**1209.6.4 Meter Protection.** Meters shall be protected against overpressure, back pressure, and vacuum where such conditions are anticipated.

**1209.6.5 Identification.** Gas piping at multiple meter installations shall be marked by a metal tag or other permanent means attached by the installing agency, designating the building or the part of the building being supplied.

### 1209.7 Gas Pressure Regulators.

**1209.7.1 Where Required.** A line gas pressure regulator or gas equipment pressure regulator, as applicable, shall be installed where the gas supply pressure is higher than that at which the branch supply line or gas utilization equipment is designed to operate or varies beyond design pressure limits.

**1209.7.2 Listing.** Line gas pressure regulator shall be listed in accordance with ANSI Z21.80.

**1209.7.3 Location.** The gas pressure regulator shall be accessible for servicing.

**1209.7.4 Regulator Protection.** Pressure regulators shall be protected against physical damage.

#### 1209.7.5 Venting.

##### (A) Line Gas Pressure Regulators.

- (1) An independent vent to the outside of the building, sized in accordance with the regulator manufacturer's instructions, shall be provided where the location of a regulator is such that a ruptured diaphragm will cause a hazard. Where there is more than one regulator at a location, each regulator shall have a separate vent to the outside, or if approved by the Authority Having Jurisdiction, the vent lines shall be permitted to be manifolded in accordance with accepted engineering

practices to minimize back pressure in the event of diaphragm failure. [See NFPA 54:5.9.7] for information on properly locating the vent.) Materials for vent piping shall be in accordance with Section 1209.5.

**Exception:** A regulator and vent-limiting means combination listed as complying with ANSI Z21.80, Standard for Line Pressure Regulators, shall be permitted to be used without a vent to the outdoors.

*The following references were extracted from NFPA 54:*

5.9.7 Vents. The discharge stacks, vents or outlet parts of all pressure-relieving and pressure-limiting devices shall be located so that gas is safely discharged into the outside atmosphere.

Discharge stacks or vents shall be designed to prevent the entry of water, insects, or any other foreign material that could cause blockage. The discharge stack or vent line shall be at least the same size as the outlet of the pressure-relieving device.

- (2) The vent shall be designed to prevent the entry of water, insects, or other foreign materials that could cause blockage.
- (3) At locations where regulators might be submerged during floods, a special antiflood-type breather vent fitting shall be installed, or the vent line shall be extended above the height of the expected flood waters.
- (4) A regulator shall not be vented to the gas equipment flue or exhaust system.

**(B) Gas Appliance Pressure Regulators.** For venting of gas appliance pressure regulators [see NFPA 54: 8.1.19].

*The following references were extracted from NFPA 54:*

8.1.19 Venting of Gas Appliance Pressure Regulators. Venting of gas appliance pressure regulators shall comply with the following requirements:

- (1) Gas appliance pressure regulators requiring access to the atmosphere for successful shall be equipped with vent piping leading outdoors or, if the regulator vent is an integral part of the equipment, into the combustion chamber adjacent to a continuous pilot, unless constructed or

*equipped with a vent-limiting means to limit the escape of gas from the vent opening in the event of diaphragm failure.*

- (2) *Vent-limiting means shall be employed on listed gas appliance pressure regulators only.*
- (3) *In the case of vents leading outdoors, means shall be employed to prevent water from entering this piping and also to prevent blockage of vents by insects and foreign matter.*
- (4) *Under no circumstances shall a regulator be vented to the gas utilization equipment flue or exhaust system.*
- (5) *In the case of vents entering the combustion chamber, the vent shall be located so the escaping gas will be readily ignited by the pilot and the heat liberated thereby will not adversely affect the normal operation of the safety shutoff system. The terminus of the vent shall be securely held in a fixed position relative to the pilot. For manufactured gas, the need for a flame arrester in the vent piping shall be determined.*
- (6) *Vent lines from a gas appliance pressure regulator and bleed lines from a diaphragm-type valve shall not be connected to a common manifold terminating in a combustion chamber. Vent lines shall not terminate in positive-pressure-type combustion chambers.*

**1209.7.6 Bypass Piping.** Valved and regulated bypasses shall be permitted to be placed around gas line pressure regulators where continuity of service is imperative.

**1209.7.7 Identification.** Line pressure regulators at multiple regulator installations shall be marked by a metal tag or other permanent means designating the building or the part of the building being supplied.

#### **1209.8 Back Pressure Protection.**

**1209.8.1 Where to Install.** Protective devices shall be installed as close to the utilization equipment as practical where the design of utilization equipment connected is such that air, oxygen, or standby gases could be forced into the gas supply system. Gas and air combustion mixers incorporating double diaphragm "zero" or "atmosphere" governors or regulators shall require no further protection unless connected directly to compressed air or oxygen at pressures of 5 psi (34 kPa) or more.

**1209.8.2 Protective Devices.** Protective devices shall include but not be limited to the following:

- (1) Check valves
- (2) Three-way valves (of the type that completely closes one side before starting to open the other side)
- (3) Reverse flow indicators controlling positive shutoff valves
- (4) Normally closed air-actuated positive shutoff pressure regulators

#### **1209.9 Low-Pressure Protection.**

A protective device shall be installed between the meter and the gas utilization equipment if the operation of the equipment (i.e., gas compressors) is such that it could produce a vacuum or a dangerous reduction in gas pressure at the meter. Such devices include, but are not limited to, mechanical, diaphragm-operated, or electrically operated low-pressure shutoff valves.

**1209.10 Shutoff Valves.** Shutoff valves shall be approved and shall be selected giving consideration to pressure drop, service involved, emergency use, and reliability of operation. Shutoff valves of size 1 in. National Pipe Thread and smaller shall be listed.

#### **1209.11 Expansion and Flexibility.**

**1209.11.1 Design.** Piping systems shall be designed to have sufficient flexibility to prevent thermal expansion or contraction from causing excessive stresses in the piping material, excessive bending or loads at joints, or undesirable forces or moments at points of connections to equipment and at anchorage or guide points. Formal calculations or model tests shall be required only where reasonable doubt exists as to the adequate flexibility of the system.

Flexibility shall be provided by the use of bends, loops, offsets, or couplings of the slip type. Provision shall be made to absorb thermal changes by the use of expansion joints of the bellows type, or by the use of "ball" or "swivel" joints. Expansion joints of the slip type shall not be used inside buildings or for thermal expansion. Where expansion joints are used, anchors or ties of sufficient strength and rigidity shall be installed to provide for end forces due to fluid pressure and other causes.

Pipe alignment guides shall be used with expansion joints according to the recommended practice of the joint manufacturer.

**1209.11.2 Special Local Conditions.** Where local conditions include earthquake, tornado, unstable ground, or flood hazards, special consideration shall be given to increased strength and flexibility of piping supports and connections.



**1210.0 RESERVED****1211.0 Gas Piping Installation.****1211.1 Piping Underground.**

**1211.1.1 Clearances.** Underground gas piping shall be installed with sufficient clearance from any other underground structure to avoid contact therewith, to allow maintenance, and to protect against damage from proximity to other structures. In addition, underground plastic piping shall be installed with sufficient clearance or shall be insulated from any source of heat so as to prevent the heat from impairing the serviceability of the pipe.

**1211.1.2 Protection Against Damage.**

**(A) Cover Requirements.** Underground piping systems shall be installed with a minimum of 18 in. (460 mm) of cover. Where external damage to the pipe is not likely to result, the minimum cover shall be 12 in. (300 mm). Where a minimum of 12 in. (300 mm) of cover cannot be provided, the pipe shall be installed in conduit or bridged (shielded).

**(B) Trenches.** The trench shall be graded so that the pipe has a firm, substantially continuous bearing on the bottom of the trench.

**(C) Backfilling.** Where flooding of the trench is done to consolidate the backfill, care shall be exercised to see that the pipe is not floated from its firm bearing on the trench bottom.

**1211.1.3 Protection Against Corrosion.** Gas piping in contact with earth or other material that could corrode the piping shall be protected against corrosion in an approved manner. When dissimilar metals are joined underground, an insulating coupling or fitting shall be used. Piping shall not be laid in contact with cinders. Uncoated threaded or socket-welded joints shall not be used in piping in contact with soil or where internal or external crevice corrosion is known to occur.

**1211.1.4 Protection Against Freezing.** Where the formation of hydrates or ice is known to occur, piping shall be protected against freezing.

**1211.1.5 Piping Through Foundation Wall.** Underground piping, where installed through the outer foundation or basement wall of a building, shall be encased in a protective pipe. The space between the gas piping and the building shall be sealed to prevent entry of gas or water.

**1211.1.6 Piping Underground Beneath Buildings.** Where the installation of gas piping

underground beneath buildings is unavoidable, the piping shall be encased in an approved conduit designed to withstand the superimposed loads. The conduit shall extend into a normally usable and accessible portion of the building and, at the point where the conduit terminates in the building, the space between the conduit and the gas piping shall be sealed to prevent the possible entrance of any gas leakage. Where the end sealing is of a type that will retain the full pressure of the pipe, the conduit shall be designed for the same pressure as the pipe. The conduit shall extend at least 4 in. (100 mm) outside the building, be vented above grade to the outside, and be installed so as to prevent the entrance of water and insects. [NFPA 54: 6.1.6]

**1211.1.7 Plastic Pipe.**

**(A) Connection of Plastic Piping.** Plastic pipe shall be installed outside, underground only.

**Exception No. 1:** Plastic pipe shall be permitted to terminate above ground where an anodeless riser is used.

**Exception No. 2:** Plastic pipe shall be permitted to terminate with a wall head adapter above ground in buildings, including basements, where the plastic pipe is inserted in a piping material permitted for use in buildings.

**(B)** Connections made outside and underground between metallic and plastic piping shall be made only with ASTM D 2513, *Standard Specification for Thermoplastic Gas Pressure Pipe, Tubing, and Fittings, Category I transition fittings*.

**(C)** An electrically continuous corrosion-resistant tracer wire (minimum AWG 14) or tape shall be buried with the plastic pipe to facilitate locating. One end shall be brought above ground at a building wall or riser.

**1211.2 Installation of Piping.**

**1211.2.1** Piping installed above ground shall be securely supported and located where it will be protected from physical damage (also see 1211.1.4). Where passing through an outside wall, the piping shall also be protected against corrosion by coating or wrapping with an inert material approved for such applications. Where piping is encased in a protective pipe sleeve, the annular space between the gas piping and the sleeve shall be sealed at the wall to prevent the entry of water, insects, or rodents.

**1211.2.2 Building Structure.**

(1) The installation of gas piping shall not cause

structural stresses within building components to exceed allowable design limits.

- (2) Approval shall be obtained before any beams or joists are cut or notched. Permission shall be obtained from the Authority Having Jurisdiction.

**1211.2.3 Other than Dry Gas.** Drips, sloping, protection from freezing, and branch pipe connections, as provided for in 1211.1.4, 1211.6.1, and Section 1211.8, shall be provided when other than dry gas is distributed and climactic conditions make such provisions necessary.

**1211.2.4 Gas Piping to be Sloped.** Piping for other than dry gas conditions shall be sloped not less than 1/4 in. in 15 ft (7 mm in 4.6 m) to prevent traps.

**1211.2.4.1 Ceiling Locations.** Gas piping shall be permitted to be installed in accessible spaces between a fixed ceiling and a dropped ceiling, whether or not such spaces are used as a plenum. Valves shall not be located in such spaces.

**Exception:** Equipment shutoff valves required by this code shall be permitted to be installed in accessible spaces containing vented gas utilization equipment.

**1211.2.5 Prohibited Locations.** Gas piping inside any building shall not be installed in or through a circulating air duct, clothes chute, chimney or gas vent, ventilating duct, dumbwaiter, or elevator shaft. This provision shall not apply to ducts used to provide combustion and ventilation air in accordance with Section 507.0 or to above-ceiling spaces as covered in 1211.2.4.1.

**1211.2.6 Hangers, Supports, and Anchors.**

- (A) Piping shall be supported with pipe hooks, metal pipe straps, bands, brackets, or hangers suitable for the size of piping, be of adequate strength and quality, and located at intervals so as to prevent or damp out excessive vibration. Piping shall be anchored to prevent undue strains on connected equipment and shall not be supported by other piping. Pipe hangers and supports shall conform to the requirements of ANSI/MSS SP-58, *Pipe Hangers and Supports - Materials, Design and Manufacture*.
- (B) Spacings of supports in gas-piping installations shall not be greater than shown in Table 12-3. Spacing of supports for CSST shall be in accordance with the CSST manufacturer's instruction.

- (C) Supports, hangers, and anchors shall be installed so as not to interfere with the free expansion and contraction of the piping between anchors. All parts of the supporting equipment shall be designed and installed so they will not be disengaged by movement of the supported piping.

**TABLE 12-3  
Support of Piping**

Steel Pipe, Nominal Size of Pipe (in.)	Spacing of Supports (ft.)	Nominal Size of Tubing Smooth-wall (In. O.D.)	Spacing of Supports (ft.)
1/2	6	1/2	4
3/4 or 1	8	5/8 or 3/4	6
1-1/4 or larger (horizontal)	10	7/8 or 1 (horizontal)	8
1-1/4 or larger (vertical)	every floor level	1 or larger (vertical)	every floor level

For SI units: 1 ft = 0.305 m.

**1211.2.7 Removal of Pipe.** Where piping containing gas is to be removed, the line shall be first disconnected from all sources of gas and then thoroughly purged with air, water, or inert gas before any cutting or welding is done. (See Section 1214.7.)

**1211.3 Concealed Piping in Buildings.**

**1211.3.1 General.** Gas piping in concealed locations shall be installed in accordance with this section.

**1211.3.2 Connections.** Where gas piping is to be concealed, unions, tubing fittings, right and left couplings, bushings, swing joints, and compression couplings made by combinations of fittings shall not be used. Connections shall be of the following type:

- (1) Pipe fittings such as elbows, tees, and couplings
- (2) Joining tubing by brazing (See 1209.5.8.2.)
- (3) Fittings listed for use in concealed spaces that have been demonstrated to sustain, without leakage, any forces due to temperature expansion or contraction, vibration, or fatigue based on their geographic location, application, or operation.
- (4) Where necessary to insert fittings in gas pipe that has been installed in a concealed

location, the pipe shall be reconnected by welding, flanges, or the use of a ground joint union with the nut center-punched to prevent loosening by vibration.

**1211.3.3 Piping in Partitions.** Concealed gas piping shall not be located in solid partitions.

**1211.3.4 Tubing in Partitions.** This provision shall not apply to tubing that pierces walls, floors, or partitions or to tubing installed vertically and horizontally inside hollow walls or partitions without protection along its entire concealed length where both of the following requirements are met:

- (1) A steel striker barrier not less than 0.0508 in. (1.3 mm) thick, or equivalent, is installed between the tubing and the finished wall and extends at least 4 in. (100 mm) beyond concealed penetrations of plates, fire stops, wall studs, and so on.
- (2) The tubing is installed in single runs and is not rigidly secured.

**1211.3.5 Piping in Floors.** In industrial occupancies, gas piping in solid floors such as concrete shall be laid in channels in the floor and covered to permit access to the piping with a minimum of damage to the building. Where piping in floor channels could be exposed to excessive moisture or corrosive substances, the piping shall be protected in an approved manner.

**Exception:** In other than industrial occupancies and where approved by the Authority Having Jurisdiction, gas piping embedded in concrete floor slabs constructed with portland cement shall be surrounded with a minimum of 1-1/2 in. (38 mm) of concrete and shall not be in physical contact with other metallic structures such as reinforcing rods or electrically neutral conductors. All piping, fittings, and risers shall be protected against corrosion in accordance with 1209.5.6. Piping shall not be embedded in concrete slabs containing quickset additives or cinder aggregate.

**1211.4 Piping in Vertical Chases.** (See Section 1202.0.) Where gas piping exceeding 5 psi (34 kPa) is located within vertical chases in accordance with 5.5.1(2), the requirements of 1211.4.1 through 1211.4.3 shall apply.

*The following references were extracted from NFPA 54:*

*5.5.1 Maximum Design Operating Pressure. The maximum design operating pressure for piping systems located inside buildings shall not exceed 5 psi (34 kPa) unless one or more of the following conditions are met:*

- (1) *The piping system is welded.*
- (2) *The piping is located in a ventilated chase or otherwise enclosed for protection against accidental gas accumulation.*
- (3) *The piping is located inside buildings or separate areas of buildings used exclusively for one of the following:*
  - (a) *Industrial processing or heating*
  - (b) *Research*
  - (c) *Warehousing*
  - (d) *Boiler or mechanical equipment rooms*
- (4) *The piping is a temporary installation for buildings under construction.*

**1211.4.1 Pressure Reduction.** (See Section 1202.0) Where pressure reduction is required in branch connections for compliance with NFPA 54 Section 5.5.1, such reduction shall take place either inside the chase or immediately adjacent to the outside wall of the chase. Regulator venting and downstream overpressure protection shall comply with 1209.7.4 and NFPA Section 5.9. The regulator shall be accessible for service and repair and vented in accordance with one of the following:

- (1) Where the fuel gas is lighter than air, regulators equipped with a vent-limiting means shall be permitted to be vented into the chase. Regulators not equipped with a vent-limiting means shall be permitted to be vented either directly to the outdoors or to a point within the top 1 ft (0.3m) of the chase.
- (2) Where the fuel gas is heavier than air, the regulator vent shall be vented only directly to the outdoors.

**1211.4.2 Construction.** Chase construction shall comply with local building codes with respect to fire resistance and protection of horizontal and vertical openings.

**1211.4.3 Ventilation.** A chase shall be ventilated to the outdoors and only at the top. The openings shall have a minimum free area (in square inches) equal to the product of one-half of the maximum pressure in the piping (in psi) times the largest nominal diameter of that piping (in inches), or the cross-sectional area of the chase, whichever is smaller. Where more than one fuel gas piping system is present, the free area for each system shall be calculated and the largest area used.

**1211.5 Gas Pipe Turns.** Changes in direction of gas pipe shall be made by the use of fittings, factory bends, or field bends.

**1211.5.1 Metallic Pipe.** Metallic pipe bends shall comply with the following:

- (1) Bends shall be made only with bending equipment and procedures intended for that purpose.
- (2) All bends shall be smooth and free from buckling, cracks, or other evidence of mechanical damage.
- (3) The longitudinal weld of the pipe shall be near the neutral axis of the bend.
- (4) Pipe shall not be bent through an arc of more than 90 degrees.
- (5) The inside radius of a bend shall be not less than six times the outside diameter of the pipe.

**1211.5.2 Plastic Pipe.** Plastic pipe bends shall comply with the following:

- (1) The pipe shall not be damaged, and the internal diameter of the pipe shall not be effectively reduced.
- (2) Joints shall not be located in pipe bends.
- (3) The radius of the inner curve of such bends shall not be less than 25 times the inside diameter of the pipe.
- (4) Where the piping manufacturer specifies the use of special bending equipment or procedures, such equipment or procedures shall be used.

**1211.5.3 Mitered Bends.**

Mitered bends shall be permitted subject to the following limitations:

- (1) Miters shall not be used in systems having a design pressure greater than 50 psi (340 kPa). Deflections caused by misalignments up to 3 degrees shall not be considered as miters.
- (2) The total deflection angle at each miter shall not exceed 90 degrees.

**1211.5.4 Elbows.** Factory-made welding elbows or transverse segments cut therefrom shall have an arc length measured along the crotch of at least 1 in. (25 mm) for pipe sizes 2 in. and larger.

**1211.6 Drips and Sediment Traps.**

**1211.6.1 Provide Drips Where Necessary.** For other than dry gas conditions, a drip shall be provided at any point in the line of pipe where condensate could collect. Where required by the Authority Having Jurisdiction or the serving gas supplier, a drip shall also be provided at the outlet of the meter. This drip shall be so installed as to constitute a trap wherein an accumulation

of condensate will shut off the flow of gas before it will run back into the meter.

**1211.6.2 Location of Drips.** All drips shall be installed only in such locations that they will be readily accessible to permit cleaning or emptying. A drip shall not be located where the condensate is likely to freeze.

**1211.6.3 Sediment Traps. (See Section 1212.7.)**

**1211.7 Outlets.**

**1211.7.1 Location and Installation.**

- (1) The outlet fittings or piping shall be securely fastened in place.
- (2) Outlets shall not be located behind doors.
- (3) Outlets shall be located far enough from floors, walls, patios, slabs, and ceilings to permit the use of wrenches without straining, bending, or damaging the piping.
- (4) The unthreaded portion of gas piping outlets shall extend not less than 1 in. (25 mm) through finished ceilings or indoor or outdoor walls.
- (5) The unthreaded portion of gas-piping outlets shall extend not less than 2 in. (50 mm) above the surface of floors or outdoor patios or slabs.
- (6) The provisions of Sections 1211.7.1 (4) and (5) shall not apply to listed quick-disconnect devices of the flush-mounted type or listed gas convenience outlets. Such devices shall be installed in accordance with the manufacturers' installation instructions.

**1211.7.2 Cap All Outlets.**

- (A) Each outlet, including a valve, shall be closed gastight with a threaded plug or cap immediately after installation and shall be left closed until the gas utilization equipment is connected thereto. When equipment is disconnected from an outlet and the outlet is not to be used again immediately, it shall be closed gastight.

**Exception No. 1:** Laboratory equipment installed in accordance with 1212.2(A) shall be permitted.

**Exception No. 2:** The use of a listed quick-disconnect device with integral shutoff or listed gas convenience outlet shall be permitted.

- (B) Equipment shutoff valves installed in fireplaces shall be removed and the piping capped gastight where the fireplace is used for solid fuel burning.

**1211.8 Branch Pipe Connection.** When a branch outlet is placed on a main supply line before it is known what size pipe will be connected to it, the outlet shall be of the same size as the line that supplies it.

**1211.9 Manual Gas Shutoff Valves.** (Also see Section 1212.4.)

**1211.9.1 Valves at Regulators.** An accessible gas shutoff valve shall be provided upstream of each gas pressure regulator. Where two gas pressure regulators are installed in series in a single gas line, a manual valve shall not be required at the second regulator.

**1211.9.2 Valves Controlling Multiple Systems.**

**(A) Accessibility of Gas Valves.** Main gas shutoff valves controlling several gas piping systems shall be readily accessible for operation and installed so as to be protected from physical damage. They shall be marked with a metal tag or other permanent means attached by the installing agency so that the gas piping systems supplied through them can be readily identified.

**(B) Shutoff Valves for Multiple House Lines.** In multiple-tenant buildings supplied through a master meter, or through one service regulator where a meter is not provided, or where meters or service regulators are not readily accessible from the equipment location, an individual shutoff valve for each apartment or tenant line shall be provided at a convenient point of general accessibility.

In a common system serving a number of individual buildings, shutoff valves shall be installed at each building.

**1211.9.3 Emergency Shutoff Valves.** An exterior shutoff valve to permit turning off the gas supply to each building in an emergency shall be provided. The emergency shutoff valves shall be plainly marked as such and their locations posted as required by the Authority Having Jurisdiction.

**1211.10 Prohibited Devices.** No device shall be placed inside the gas piping or fittings that will reduce the cross-sectional area or otherwise obstruct the free flow of gas, except where proper allowance in the piping system design has been made for such a device and where approved by the Authority Having Jurisdiction.

**1211.11 Systems Containing Gas-Air Mixtures Outside the Flammable Range.** Where gas-air mixing machines are employed to produce mixtures above or below the flammable range, they shall be

provided with stops to prevent adjustment of the mixture to within or approaching the flammable range.

**1211.12 Systems Containing Flammable Gas-Air Mixtures.**

**1211.12.1 Required Components.** A central premix system with a flammable mixture in the blower or compressor shall consist of the following components:

- (1) Gas-mixing machine in the form of an automatic gas-air proportioning device combined with a downstream blower or compressor
- (2) Flammable mixture piping, minimum Schedule 40 NPS
- (3) Automatic firechecks
- (4) Safety blowouts or backfire preventers for systems utilizing flammable mixture lines above 2-1/2 in. nominal pipe size or the equivalent

**1211.12.2 Optional Components.**

The following components shall also be permitted to be utilized in any type of central premix system:

- (1) Flow meters
- (2) Flame arresters

**1211.12.3 Additional Requirements.** Gas-mixing machines shall have nonsparking blowers and shall be so constructed that a flashback will not rupture machine casings.

**1211.12.4 Special Requirements for Mixing Blowers.** A mixing blower system shall be limited to applications with minimum practical lengths of mixture piping, limited to a maximum mixture pressure of 10 in. water column (25 Pa) and limited to gases containing no more than 10 percent hydrogen.

The blower shall be equipped with a gas-control valve at its air entrance so arranged that gas is admitted to the airstream, entering the blower in proper proportions for correct combustion by the type of burners employed, the said gas-control valve being of either the zero governor or mechanical ratio valve type that controls the gas and air adjustment simultaneously. No valves or other obstructions shall be installed between the blower discharge and the burner or burners.

**1211.12.5 Installation of Gas-Mixing Machines.**

- (A)** The machine shall be located in a large, well-ventilated area or in a small detached building or cutoff room provided with room

construction and explosion vents in accordance with sound engineering principles. Such rooms or belowgrade installations shall have adequate positive ventilation.

- (B) Where gas-mixing machines are installed in well-ventilated areas, the type of electrical equipment shall be in accordance with NFPA 70, *National Electrical Code*<sup>®</sup>, for general service conditions unless other hazards in the area prevail. Where gas-mixing machines are installed in small detached buildings or cutoff rooms, the electrical equipment and wiring shall be installed in accordance with NFPA 70, *National Electrical Code*, for hazardous locations (Articles 500 and 501, Class I, Division 2).
- (C) Air intakes for gas-mixing machines using compressors or blowers shall be taken from outdoors whenever practical.
- (D) Controls for gas-mixing machines shall include interlocks and a safety shutoff valve of the manual reset type in the gas supply connection to each machine arranged to automatically shut off the gas supply in the event of high or low gas pressure. Except for open burner installations only, the controls shall be interlocked so that the blower or compressor will stop operating following a gas supply failure. Where a system employs pressurized air, means shall be provided to shut off the gas supply in the event of air failure.
- (E) Centrifugal gas-mixing machines in parallel shall be reviewed by the user and equipment manufacturer before installation, and means or plans for minimizing these effects of downstream pulsation and equipment overload shall be prepared and utilized as needed.

#### **1211.12.6 Use of Automatic Firechecks, Safety Blowouts, or Backfire Preventers.**

Automatic firechecks and safety blowouts or backfire preventers shall be provided in piping systems distributing flammable air-gas mixtures from gas-mixing machines to protect the piping and the machines in the event of flashback, in accordance with the following:

- (A) Approved automatic firechecks shall be installed upstream as close as practicable to the burner inlets following the firecheck manufacturers' instructions.

- (B) A separate manually operated gas valve shall be provided at each automatic firecheck for shutting off the flow of gas-air mixture through the firecheck after a flashback has occurred. The valve shall be located upstream as close as practical to the inlet of the automatic firecheck.

#### **CAUTION:**

These valves shall not be reopened after a flashback has occurred until the firecheck has cooled sufficiently to prevent reignition of the flammable mixture and has been reset properly.

- (C) A safety blowout or backfiring preventer shall be provided in the mixture line near the outlet of each gas-mixing machine where the size of the piping is larger than 2-1/2 in. NPS, or equivalent, to protect the mixing equipment in the event of an explosion passing through an automatic firecheck. The manufacturers' instructions shall be followed when installing these devices, particularly after a disc has burst.

The discharge from the safety blowout or backfire preventer shall be located or shielded so that particles from the ruptured disc cannot be directed toward personnel. Wherever there are interconnected installations of gas-mixing machines with safety blowouts or backfire preventers, provision shall be made to keep the mixture from other machines from reaching any ruptured disc opening. Check valves shall not be used for this purpose.

- (D) Large-capacity premix systems provided with explosion heads (rupture disc) to relieve excessive pressure in pipelines shall be located at and vented to a safe outdoor location. Provisions shall be provided for automatically shutting off the supply of gas-air mixture in the event of rupture.

#### **1211.13 Electrical Bonding and Grounding**

- (A) Each aboveground portion of a gas piping system that is likely to become energized shall be electrically continuous and bonded to an effective ground-fault current path. Gas piping shall be considered to be bonded when it is connected to gas utilization equipment that is connected to the equipment grounding conductor of the circuit supplying that equipment.
- (B) Gas piping shall not be used as a grounding conductor or electrode.

**1211.14 Electrical Circuits.** Electrical circuits shall not utilize gas piping or components as conductors.

**Exception:** Low-voltage (50 V or less) control circuits, ignition circuits, and electronic flame detection device circuits shall be permitted to make use of piping or components as a part of an electric circuit.

#### 1211.15 Electrical Connections.

- (A) All electrical connections between wiring and electrically operated control devices in a piping system shall conform to the requirements of NFPA 70, *National Electrical Code*. (See Section 1211.13.)
- (B) Any essential safety control depending on electric current as the operating medium shall be of a type that will shut off (fail safe) the flow of gas in the event of current failure.

#### 1211.16 Pipe Sizing Methods.

**1211.16.1** Where the pipe size is to be determined using any of the methods in sections 1211.16.1.1 through 1211.16.1.3, the diameter of each pipe segment shall be obtained from the pipe-sizing tables in Section 1211.16.2 or from the sizing equations in section 1211.16.3.

**1211.16.1.1 Longest Length Method.** The pipe size of each section of gas piping shall be determined using the longest length of piping from the point of delivery to the most remote outlet and the load of the section.

**1211.16.1.2 Branch Length Method.** Pipe shall be sized as follows:

- (A) Pipe size of each section of the longest pipe run from the point of delivery to the most remote outlet shall be determined using the longest run of piping and the load of the section.
- (B) The pipe size of each section of branch piping not previously sized shall be determined using the length of piping from the point of delivery to the most remote outlet in each branch and the load of the section.

**1211.16.1.3 Hybrid Pressure.** The pipe size for each section of higher pressure gas piping shall be determined using the longest length of piping from the point of delivery to the most remote line pressure regulator. The pipe size from the line pressure regulator to each outlet shall be determined

using the length of piping from the regulator to the most remote outlet served by the regulator.

**1211.16.2 Tables for Sizing Gas-Piping Systems.** Tables 12-7 through 12-23 shall be used to size gas piping in conjunction with one of the methods described in sections 1211.16.1.1 through 1211.16.1.3.

**1211.16.3 Sizing Equations.** The inside diameter of smooth wall pipe or tubing shall be determined by the sizing equations 12-1 and 12-2 using the equivalent pipe length determined by methods 1211.16.1.1 through 1211.16.1.3.

**Equation 12-1 Low-Pressure Gas Formula (Less than 1.5 psi [10.3 kPa]):**

$$D = \frac{Q^{0.381}}{19.17 \left( \frac{\Delta H}{Cr \times L} \right)^{0.206}}$$

where:

D = inside diameter of pipe, in.

Q = input rate appliance(s), cubic feet per hour at 60°F (16°C) and 30 in. (759 mm) mercury column

P<sub>1</sub> = upstream pressure, psia (P<sub>1</sub> + 14.7)

P<sub>2</sub> = downstream pressure, psia (P<sub>2</sub> + 14.7)

L = equivalent length of pipe, ft

ΔH = pressure drop, in. water column (27.7 in. H<sub>2</sub>O = 1 psi)

**Equation 12-2 High-Pressure Gas Formula (1.5 psi [10.3 kPa] and above):**

$$D = \frac{Q^{0.381}}{18.93 \left[ \frac{(P_1^2 - P_2^2) \cdot Y}{Cr \times L} \right]^{0.206}}$$

where:

D = inside diameter of pipe, in.

Q = input rate appliance(s), cubic feet per hour at 60°F (16°C) and 30 in. (759 mm) mercury column

P<sub>1</sub> = upstream pressure, psia (P<sub>1</sub> + 14.7)

P<sub>2</sub> = downstream pressure, psia (P<sub>2</sub> + 14.7)

L = equivalent length of pipe, ft.

ΔH = pressure drop, in. water column (27.7 in. H<sub>2</sub>O = 1 psi)

**TABLE 12-4**  
**Cr and Y for Natural Gas and Undiluted Propane**  
**at Standard Conditions**

Formula Factors Gas	Cr	Y
Natural Gas	0.6094	0.9992
Undiluted Propane	1.2462	0.9910

For SI units, 1 ft<sup>3</sup> = 0.028 m<sup>3</sup>; 1 ft = 0.305 m; 1 in. water column = 0.249 kPa; 1 psi = 6.894 kPa; 1000 Btu/h = 0.293 kW.

### 1212.0 Equipment Connections to Building Piping.

**1212.1 Connecting Gas Equipment.** Gas utilization equipment shall be connected to the building piping in compliance with 1212.4 and 1212.5 by one of the following:

- (1) Rigid metallic pipe and fittings.
- (2) Semirigid metallic tubing and metallic fittings. Aluminum alloy tubing shall not be used in exterior locations.
- (3) Listed flexible gas connectors in compliance with ANSI Z21.24, *Standard for Connectors for Gas Appliances*. The connector shall be used in accordance with the terms of their listing that are completely in the same room as the equipment.
- (4) CSST where installed in accordance with the manufacturer's instructions.
- (5) Listed non-metallic gas hose connectors in accordance with 1212.2.
- (6) Gas-fired food service (commercial cooking) equipment listed for use with casters or otherwise subject to movement for cleaning, and other large and heavy gas utilization equipment that can be moved, shall be connected in accordance with the connector manufacturer's installation instructions using a listed appliance connector complying with ANSI Z21.69, *Standard for Connectors for Movable Gas Appliances*.
- (7) In 1212.1(2), (3), and (5), the connector or tubing shall be installed so as to be protected against physical and thermal damage. Aluminum alloy tubing and connectors shall be coated to protect against external corrosion where they are in contact with masonry, plaster, or insulation or are subject to repeated wettings by such liquids as water (except rain water), detergents, or sewage.

**1212.2 Use of Non-Metallic Gas Hose Connectors.** Listed non-metallic gas hose connectors shall be used in accordance with the terms of their listing and as follows:

- (A) **Indoor.** Indoor gas hose connectors shall be used only to connect laboratory, shop, and ironing equipment requiring mobility during operation. An equipment shutoff valve shall be installed where the connector is attached to the building piping. The connector shall be of minimum length and shall not exceed 6 ft (1.8 m). The connector shall not be concealed and shall not extend from one room to another or pass through wall partitions, ceilings, or floors.
- (B) **Outdoor.** Outdoor gas hose connectors are permitted to connect portable outdoor gas-fired equipment. An equipment shutoff valve or a listed quick-disconnect device or a listed gas convenience outlet shall be installed where the connector is attached to the supply piping and in such a manner to prevent the accumulation of water or foreign matter. This connection shall be made only in the outdoor area where the equipment is to be used.

### 1212.3 Connection of Portable and Mobile Industrial Gas Equipment.

- (A) Where portable industrial gas utilization equipment or equipment requiring mobility or subject to vibration is connected to the building gas piping system by the use of a flexible hose, the hose shall be suitable and safe for the conditions under which it can be used.
- (B) Where industrial gas utilization equipment requiring mobility is connected to the rigid piping by the use of swivel joints or couplings, the swivel joints or couplings shall be suitable for the service required, and only the minimum number required shall be installed.
- (C) Where industrial gas utilization equipment subject to vibration is connected to the building piping system by the use of all-metal flexible connectors, the connectors shall be suitable for the service required.
- (D) Where flexible connections are used, they shall be of the minimum practical length and shall not extend from one room to another or pass through any walls, partitions, ceilings, or floors. Flexible connections shall not be used in any concealed location. They shall be protected against physical or thermal damage and shall be provided with gas shutoff valves in readily accessible locations in rigid piping upstream from the flexible connections.



**1212.4 Equipment Shutoff Valves and Connections.** Gas utilization equipment connected to a piping system shall have an accessible, approved manual shutoff valve with a nondisplaceable valve member, or a listed gas convenience outlet, installed within 6 ft (1.8 m) of the equipment it serves. Where a connector is used, the valve shall be installed upstream of the connector. A union or flanged connection shall be provided downstream from this valve to permit removal of controls. Shutoff valves serving decorative gas appliances shall be permitted to be installed in fireplaces if listed for such use.

**1212.5 Quick-Disconnect Devices.** Quick-disconnect devices used to connect equipment to the building piping shall be listed. Where they are installed indoors, an approved manual shutoff valve with a nondisplaceable valve member shall be installed upstream of the quick-disconnect device.

**1212.6 Support of Chimneys.** All portions of chimneys shall be supported for the design and weight of the materials employed. Listed factory-built chimneys shall be supported and spaced in accordance with their listings and the manufacturers' instructions.

**1212.7 Sediment Trap.** Where a sediment trap is not incorporated as a part of the gas utilization equipment, a sediment trap shall be installed as close to the inlet of the equipment as practical at the time of equipment installation. The sediment trap shall be either a tee fitting with a capped nipple in the bottom outlet as illustrated in Figure 12-1 or other device recognized as an effective sediment trap. Illuminating appliances, ranges, clothes dryers, decorative vented appliances for installation in vented fireplaces, gas fireplaces, and outdoor grills shall not be required to be so equipped.

**1212.8 Installation of Piping.** Piping shall be installed in a manner not to interfere with inspection, maintenance, or servicing of the gas utilization equipment.

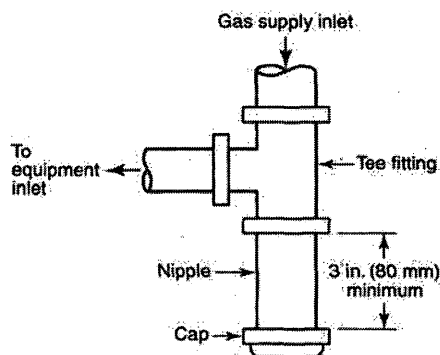

**Figure 12-1 Method of Installing a Tee Fitting Sediment Trap.**

## 1213.0 Liquefied Petroleum Gas Facilities and Piping.

Liquefied petroleum gas facilities shall comply with NFPA 58, *Liquefied Petroleum Gas Code*.

## 1214.0 Pressure Testing and Inspection.

### 1214.1 General.

**1214.1.1** Prior to acceptance and initial operation, all piping installations shall be inspected and pressure tested to determine that the materials, design, fabrication, and installation practices comply with the requirements of this code.

**1214.1.2** Inspection shall consist of visual examination during or after manufacture, fabrication, assembly, or pressure tests, as appropriate. Supplementary types of nondestructive inspection techniques, such as magnetic-particle, radiographic, and ultrasonic, shall not be required unless specifically listed herein or in the engineering design.

**1214.1.3** Where repairs or additions are made following the pressure test, the affected piping shall be tested. Minor repairs and additions are not required to be pressure tested provided that the work is inspected and connections are tested with a noncorrosive leak-detecting fluid or other leak-detecting methods approved by the Authority Having Jurisdiction.

**1214.1.4** Where new branches are installed from the point of delivery to new appliances, only the newly installed branches shall be required to be pressure tested. Connections between the new piping and the existing piping shall be tested with a noncorrosive leak-detecting fluid or approved leak-detecting methods.

**1214.1.5** A piping system shall be tested as a complete unit or in sections. Under no circumstances shall a valve in a line be used as a bulkhead between gas in one section of the piping system and test medium in an adjacent section, unless two valves are installed in series with a valved "telltale" located between these valves. A valve shall not be subjected to the test pressure unless it can be determined that the valve, including the valve-closing mechanism, is designed to safely withstand the pressure.

**1214.1.6** Regulator and valve assemblies fabricated independently of the piping system in which they are to be installed shall be permitted to be tested with inert gas or air at the time of fabrication.

**1214.1.7 Test Medium.** The test medium shall be air, nitrogen, carbon dioxide, or an inert gas. OXYGEN SHALL NEVER BE USED.

**1214.2 RESERVED****1214.3 Test Preparation.**

**1214.3.1** Pipe joints, including welds, shall be left exposed for examination during the test.

**Exception:** Covered or concealed pipe end joints that have been previously tested in accordance with this code.

**1214.3.2** Expansion joints shall be provided with temporary restraints, if required for the additional thrust load under test.

**1214.3.3** Appliances and equipment that are not to be included in the test shall be either disconnected from the piping or isolated by blanks, blind flanges, or caps. Flanged joints at which blinds are inserted to blank off other equipment during the test shall not be required to be tested.

**1214.3.4** Where the piping system is connected to appliances, equipment, or equipment components designed for operating pressures of less than the test pressure, such appliances, equipment, or equipment components shall be isolated from the piping system by disconnecting them and capping the outlets.

**1214.3.5** Where the piping system is connected to appliances, equipment, or equipment components designed for operating pressures equal to or greater than the test pressure, such appliances and equipment shall be isolated from the piping system by closing the individual equipment shutoff valves.

**1214.3.6** All testing of piping systems shall be done with due regard for the safety of employees and the public during the test. Bulkheads, anchorage, and bracing suitably designed to resist test pressures shall be installed if necessary. Prior to testing, the interior of the pipe shall be cleared of all foreign material.

**1214.4 Test Pressure.**

**1214.4.1** Test pressure shall be measured with a manometer or with a pressure-measuring device designed and calibrated to read, record, or indicate a pressure loss due to leakage during the pressure test period. The source of pressure shall be isolated before the pressure tests are made. Mechanical gauges used to measure test pressures shall have a range such that the highest end of the scale is not greater than five times the test pressure.

**1214.4.2** The test pressure to be used shall be no less than 1-1/2 times the proposed maximum working pressure, but not less than 3 psi (20 kPa), irrespective of design pressure.

**1214.4.3** Test duration shall be not less than 1/2

h for each 500 cu. ft. (14 m<sup>3</sup>) of pipe volume or fraction thereof. When testing a system having a volume less than 10 cu.ft.(0.28 m<sup>3</sup>) or a system in a single-family dwelling, the test duration shall be a minimum of 10 minutes. The duration of the test shall be a minimum of 10 minutes. The duration of the test shall not be required to exceed 24 hours.

**1214.5 Detection of Leaks and Defects.**

**1214.5.1** The piping system shall withstand the test pressure specified without showing any evidence of leakage or other defects. Any reduction of test pressures as indicated by pressure gauges shall be deemed to indicate the presence of a leak unless such reduction can be readily attributed to some other cause.

**1214.5.2** The leakage shall be located by means of an approved gas detector, a noncorrosive leak detection fluid, or other approved leak detection methods. Matches, candles, open flames, or other methods that provide a source of ignition shall not be used.

**1214.5.3** Where leakage or other defects are located, the affected portion of the piping system shall be repaired or replaced and retested. [See Section 1214.1.3.]

**1214.6 System and Equipment Leakage Test.**

**1214.6.1 Test Gases.** Leak checks using fuel gas shall be permitted in piping systems that have been pressure tested in accordance with Section 1214.0.

**1214.6.2 Before Turning Gas On.** Before gas is introduced into a system of new gas piping, the entire system shall be inspected to determine that there are no open fittings or ends and all valves at unused outlets are closed and plugged or capped.

**1214.6.3 Test for Leakage.** Immediately after the gas is turned on into a new system or into a system that has been initially restored after an interruption of service, the piping system shall be tested for leakage. Where leakage is indicated, the gas supply shall be shut off until the necessary repairs have been made.

**1214.6.4 Placing Equipment in Operation.**

Gas utilization equipment shall not be placed in operation until after the piping system has been tested in accordance with 1214.6.3 and purged in accordance with 1214.7.2.

**1214.7 Purging.**

**1214.7.1 Removal From Service.** When gas piping is to be opened for servicing, addition, or modification, the section to be worked on shall be turned off from the gas supply at the nearest convenient point and the line pressure vented to

the outdoors or to ventilated areas of sufficient size to prevent accumulation of flammable mixtures. The remaining gas in this section of pipe shall be displaced with an inert gas as required by Table 12-5.

**TABLE 12-5**  
**Length of Piping Requiring Purging with Inert Gas for Servicing or Modification**

Nominal Pipe Size (in.)	Length of Piping Requiring Purging (ft.)
2	> 50
3	> 30
4	> 15
6	> 10
8 or larger	Any length

For SI units: 1 ft = 0.305 m.

**1214.7.2 Placing in Operation.** When piping full of air is placed in operation, the air in the piping shall be displaced with fuel gas, except where such piping is required by Table 12-6 to be purged with an inert gas prior to introduction of fuel gas. The air can be safely displaced with fuel gas provided that a moderately rapid and continuous flow of fuel gas is introduced at one end of the line and air is vented out at the other end. The fuel gas flow shall be continued without interruption until the vented gas is free of air. The point of discharge shall not be left unattended during purging. After purging, the vent shall then be closed. Where required by Table 12-6, the air in the piping shall first be displaced with an inert gas, and the inert gas shall then be displaced with fuel gas.

**TABLE 12-6**  
**Length of Piping Requiring Purging with Inert Gas Before Placing in Operation**

Nominal Pipe Size (in.)	Length of Piping Requiring Purging (ft.)
3	>30
4	>15
6	>10
8 or larger	Any length

For SI units: 1 ft = 0.305 m.

**1214.7.3 Discharge of Purged Gases.** The open end of piping systems being purged shall not discharge into confined spaces or areas where there are sources of ignition unless precautions are taken to perform this operation in a safe manner by ventilation of the space, control of purging rate, and elimination of all hazardous conditions.

**1214.7.4 Placing Equipment in Operation.** After the piping has been placed in operation, all equipment shall be purged and then placed in operation, as necessary.

**1215.0 Interconnections Between Gas Piping Systems [NFPA 54: 5.3]**

**1215.1 Interconnections Supplying Separate Users.** Where two or more meters, or two or more service regulators where meters are not provided, are located on the same premises and supply separate users, the gas-piping systems shall not be interconnected on the outlet side of the meters or service regulators.

**1215.2 Interconnections for Standby Fuels.** Where supplementary gas for standby use is connected downstream from a meter or a service regulator where a meter is not provided, a device to prevent backflow shall be installed. A three-way valve installed to admit the standby supply and at the same time shut off the regular supply shall be permitted to be used for this purpose.

**1216.0 Required Gas Supply.**

**1216.1** The following regulations, as set forth in this section and in Section 1217.0, Required Gas Piping Size, shall be the standard for the installation of gas piping. All natural gas regulations and tables are based on the use of gas having a specific gravity of sixty hundredths (0.60), supplied at six (6) to eight (8) inches (152–203 mm) water column pressure at the outlet of the meter. For undiluted liquefied petroleum gas, gas piping may be sized for 2500 Btu per cubic foot (25.9 Watt-hours/L) at eleven (11) inches (279 mm) water column and specific gravity of one and fifty-two hundredths (1.52).

**Note:**

Where gas of a different specific gravity is to be delivered, the serving gas supplier should be contacted for specific gravity conversion factors to use in sizing piping systems from the pipe sizing tables in this chapter.

**1216.2** The hourly volume of gas required at each piping outlet shall be taken as not less than the maximum hourly rating as specified by the manufacturer of the appliance or appliances to be connected to each such outlet.

**1216.3** Where the gas appliances to be installed have not been definitely specified, Table 12-1 may be used as a reference to estimate requirements of typical appliances.

To obtain the cubic feet per hour (L/sec.) of gas required, divide input of appliances by the average Btu (Watt-hour) heating value per cubic foot (L) of the gas. The average Btu (Watt-hour) per cubic foot (L) of the gas in the area of the installation may be obtained from the serving gas supplier.

**1216.4** The size of the supply piping outlet for any gas appliance shall not be less than one-half (1/2) inch (15 mm).

The minimum size of any piping outlet for a mobile home shall be three-quarter (3/4) inch (20 mm).

#### **1217.0 Required Gas Piping Size.**

**1217.1** Where the maximum demand does not exceed two hundred fifty (250) cubic feet per hour (2 L/sec.) and the maximum length of piping between the meter and the most distant outlet is not over two hundred fifty (250) feet (76,200 mm), the size of each section and each outlet of any system of gas piping shall be determined by means of Table 12-7 for steel pipe, or Table 12-15 for copper tubing systems, or Table 12-19 for CSST systems. Other systems within the range of Table 12-7 or 12-15 or Table 12-19 may be sized from that table or by means of the methods set forth in Section 1217.3.

**1217.2** To determine the size of each section of pipe in any system within the range of Table 12-7, proceed as follows:

- (1) Measure the length of the pipe from the gas meter location to the most remote outlet on the system.
- (2) In Table 12-7 select the length in feet column and row showing that distance, or the next longer distance if the table does not give the exact length.
- (3) Starting at the most remote outlet, find in the row just selected the gas demand for that outlet. If the exact figure of demand is not shown, choose the next larger figure in the row.

(4) At the top of this column will be found the correct size of pipe.

(5) Using this same row, proceed in a similar manner for each section of pipe serving this outlet. For each section of pipe, determine the total gas demand supplied by that section. Where gas piping sections serve both heating and cooling equipment and the installation prevents both units from operating simultaneously, only the larger of the two demand loads need be used in sizing these sections.

(6) Size each section of branch piping not previously sized by measuring the distance from the gas meter location to the most remote outlet in that branch and follow the procedures of steps 2, 3, 4, and 5 above.

#### **Note:**

Size branch piping in the order of their distance from the meter location, beginning with the most distant outlet not previously sized.

**1217.3** For conditions other than those covered by Section 1217.1, such as longer runs or greater gas demands, the size of each gas piping system shall be determined by standard engineering methods acceptable to the Authority Having Jurisdiction, and each such system shall be so designed that the total pressure drop between the meter or other point of supply and any outlet when full demand is being supplied to all outlets, will at no time exceed five-tenths (0.5) inches (12.7 mm) water column pressure.

**1217.4** Where the gas pressure may be higher than fourteen (14) inches (356 mm) or lower than six (6) inches (152 mm) of water column, or when diversity demand factors are used, the design, pipe, sizing, materials, location, and use of such systems first shall be approved by the Authority Having Jurisdiction. Piping systems designed for pressures higher than the serving gas supplier's standard delivery pressure shall have prior verification from the gas supplier of the availability of the design pressure. Systems using undiluted liquefied petroleum gas may be sized using Table 12-11 for steel pipe and Table 12-23 for CSST for eleven (11) inches (279 mm) water column and in accordance with the provisions of Sections 1217.1 and 1217.2. For copper tubing systems using undiluted liquefied petroleum gas, the capacity of the tubing shall be determined by multiplying the values of Table 12-15 by the appropriate factor from Table 12-16.

**Figure 12-2 Example Illustrating Use of Tables 12-1 and 12-7**

Problem: Determine the required pipe size of each section and outlet of the piping system shown in Figure 12-2. Gas to be used has a specific gravity of sixty hundredths (0.60) and eleven hundred (1100) Btu per cubic foot (11.4 Watt-hour/L), delivered at eight (8) inch (203 mm) water column pressure.

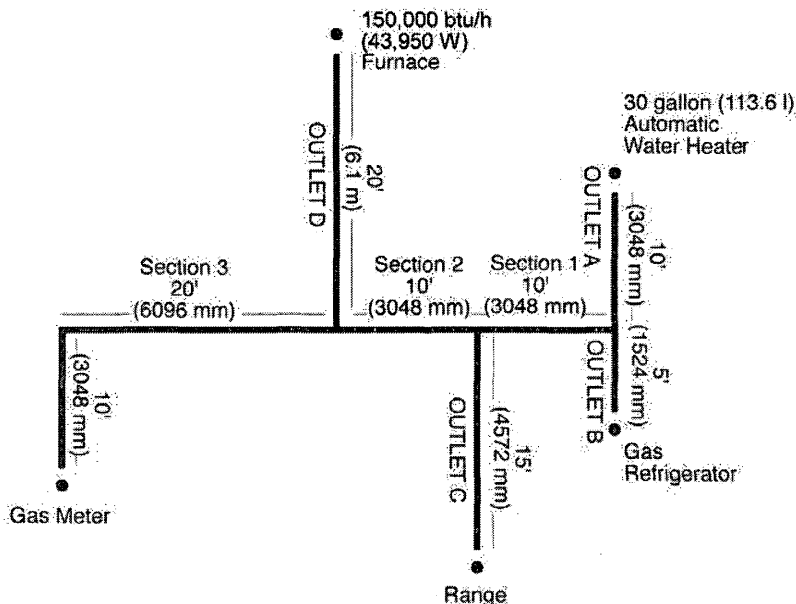

Solution:

- (1) Maximum gas demand of outlet A —  
 32 cubic feet per hour (0.21 L/sec.) (from Table 12-1).  
 Maximum gas demand of outlet B —  
 3 cubic feet per hour (0.02 L/sec.) (from Table 12-1).  
 Maximum gas demand of outlet C —  
 59 cubic feet per hour (0.46 L/sec.) (from Table 12-1).  
 Maximum gas demand of outlet D —  
 136 cubic feet per hour (1.1 L/sec.) (150,000 Btu/hour [43,950 W])  
 divided by 1100 Btu per cubic foot (11.4 Watt-hour/L)
- (2) The length of pipe from the gas meter to the most remote outlet (outlet A) is 60 feet (18,288 mm).
- (3) Using the length in feet column row marked 60 feet (18,288 mm) in Table 12-7:  
 Outlet A, supplying 32 cubic feet per hour (0.21 L/sec.), requires one-half (1/2) inch (15 mm) pipe. Section 1, supplying outlets A and B, or 35 cubic feet per hour (0.24 L/sec.) requires one-half (1/2) inch (15 mm) pipe.  
 Section 2, supplying outlets A, B, and C, or 94 cubic feet per hour (0.7 L/sec.) requires three-quarter (3/4) inch (20 mm) pipe.  
 Section 3, supplying outlets A, B, C, and D, or 230 cubic feet per hour (1.8 L/sec.), requires one (1) inch (25 mm) pipe.
- (4) Using the column marked 60 feet (18288 mm) in Table 12-7 (no column for actual length of 55 feet (16764 mm): Outlet B supplying 3 cubic feet per hour (0.02 L/sec.), requires one-half (1/2) inch (15 mm) pipe.  
 Outlet C, supplying 59 cubic feet per hour (0.46 L/sec.), requires one-half (1/2) inch (15 mm) pipe.
- (5) Using the column marked 50 feet (15,240 mm) in Table 12-7:  
 Outlet D, supplying 136 cubic feet per hour (1.1 L/sec.), requires three-quarter (3/4) inch (20 mm) pipe.

Table 12-7 Sizing of IPS Gas Piping

		Gas						Natural			
		Pressure Drop						0.5 in. w.c.			
		Specific Gravity						0.60			
		Pipe Size, inches									
		1/2	3/4	1	1-1/4	1-1/2	2	2-1/2	3	3-1/2	4
Length feet	Maximum Capacity in Cubic Feet of Gas per Hour										
	10	174	363	684	1,404	2,103	4,050	6,455	11,412	16,709	23,277
20	119	249	470	965	1,445	2,784	4,437	7,843	11,484	15,998	
30	96	200	377	775	1,161	2,235	3,563	6,299	9,222	12,847	
40	82	171	323	663	993	1,913	3,049	5,391	7,893	10,995	
50	73	152	286	588	880	1,696	2,703	4,778	6,995	9,745	
60	66	138	259	532	798	1,536	2,449	4,329	6,338	8,830	
70	61	127	239	490	734	1,413	2,253	3,983	5,831	8,123	
80	56	118	222	456	683	1,315	2,096	3,705	5,425	7,557	
90	53	111	208	428	641	1,234	1,966	3,476	5,090	7,091	
100	50	104	197	404	605	1,165	1,857	3,284	4,808	6,698	
125	44	93	174	358	536	1,033	1,646	2,910	4,261	5,936	
150	40	84	158	324	486	936	1,492	2,637	3,861	5,378	
200	34	72	135	278	416	801	1,277	2,257	3,304	4,603	
250	30	64	120	246	369	710	1,131	2,000	2,929	4,080	
300	28	58	109	223	334	643	1,025	1,812	2,654	3,697	
350	25	53	100	205	307	592	943	1,667	2,441	3,401	
400	24	49	93	191	286	551	877	1,551	2,271	3,164	
450	22	46	87	179	268	517	823	1,455	2,131	2,968	
500	21	44	82	169	253	488	778	1,375	2,013	2,804	
550	20	42	78	161	241	463	739	1,306	1,912	2,663	
600	19	40	75	153	230	442	705	1,246	1,824	2,541	

Table 12-7 (Metric) Sizing of IPS Gas Piping

		Gas									
		Natural									
		12.7 mm w.c.									
		0.60									
		Pipe Size, millimeters									
		15	20	25	32	40	50	65	80	90	100
Length meters	Maximum Delivery Capacity in Liters per Second										
	3.0	1.4	2.9	5.4	11.0	16.5	31.9	50.8	89.8	131.4	183.1
6.0	0.9	2.0	3.7	7.6	11.4	21.9	34.9	61.7	90.3	125.9	
9.0	0.8	1.6	3.0	6.1	9.1	17.6	28.0	49.6	72.5	101.1	
12.2	0.6	1.3	2.5	5.2	7.8	15.1	24.0	42.4	62.1	86.5	
15.2	0.6	1.2	2.3	4.6	6.9	13.3	21.3	37.6	55.0	76.7	
18.2	0.5	1.1	2.0	4.2	6.3	12.1	19.3	34.1	49.9	69.5	
21.3	0.5	1.0	1.9	3.9	5.8	11.1	17.7	31.3	45.9	63.9	
24.0	0.4	0.9	1.7	3.6	5.4	10.3	16.5	29.1	42.7	59.5	
27.4	0.4	0.9	1.6	3.4	5.0	9.7	15.5	27.3	40.0	55.8	
30.4	0.4	0.8	1.5	3.2	4.8	9.2	14.6	25.8	37.8	52.7	
38.0	0.3	0.7	1.4	2.8	4.2	8.1	13.0	22.9	33.5	46.7	
45.6	0.3	0.7	1.2	2.6	3.8	7.4	11.7	20.7	30.4	42.3	
60.8	0.3	0.6	1.1	2.2	3.3	6.3	10.0	17.8	26.0	36.2	
76.0	0.2	0.6	0.9	1.9	2.9	5.6	8.9	15.7	23.0	32.1	
91.2	0.2	0.5	0.9	1.8	2.6	5.1	8.1	14.3	20.9	29.1	
106.4	0.2	0.4	0.8	1.6	2.4	4.7	7.4	13.1	19.2	26.8	
121.6	0.2	0.4	0.7	1.5	2.2	4.3	6.9	12.2	17.9	24.9	
136.8	0.2	0.4	0.7	1.4	2.1	4.1	6.5	11.4	16.8	23.4	
152.0	0.2	0.3	0.6	1.3	2.0	3.8	6.1	10.8	15.8	22.1	
167.2	0.2	0.3	0.6	1.3	1.9	3.6	5.8	10.3	15.0	21.0	
182.4	0.1	0.3	0.6	1.2	1.8	3.5	5.5	9.8	14.3	20.0	

Table 12-8 Sizing of Medium Pressure Gas Piping

		Gas																																						
		Natural																																						
		Inlet Pressure																																						
		2.0 psi																																						
		Pressure Drop																																						
		1.5 psi																																						
		Specific Gravity																																						
		0.6																																						
		Pipe Size, inches																																						
		1/2	3/4	1	1-1/4	1-1/2	2	2-1/2	3	4	5	6																												
Length feet	Capacity in Cubic Feet of Gas per Hour																																							
	50	100	150	200	250	300	350	400	450	500	550	600	650	700	750	800	850	900	950	1000	1100	1200	1300	1400	1500	1600	1700	1800	1900	2000	2100	2200	2300	2400	2500	2600				
50	466	974	1,834	3,766	5,642	10,867	17,320	30,618																																
100	320	669	1,261	2,588	3,878	7,469	11,904	21,044																																
150	257	537	1,012	2,078	3,114	5,998	9,559	16,899																																
200	220	460	866	1,799	2,665	5,133	8,181	14,463																																
250	195	408	768	1,577	2,362	4,549	7,251	12,818																																
300	177	369	696	1,429	2,140	4,122	6,570	11,614																																
350	163	340	640	1,314	1,969	3,792	6,044	10,685																																
400	151	316	595	1,223	1,832	3,528	5,623	9,940																																
450	142	297	559	1,147	1,719	3,310	5,276	9,327																																
500	134	280	528	1,084	1,624	3,127	4,984	8,810																																
550	127	266	501	1,029	1,542	2,970	4,733	8,367																																
600	121	254	478	982	1,471	2,833	4,515	7,983																																
650	116	243	458	940	1,409	2,713	4,324	7,644	15,592																															
700	112	234	440	903	1,353	2,606	4,154	7,344	14,979																															
750	108	225	424	870	1,304	2,511	4,002	7,075	14,430																															
800	104	217	409	840	1,259	2,425	3,865	6,832	13,935																															
850	101	210	396	813	1,218	2,347	3,740	6,612	13,486																															
900	97	204	384	788	1,181	2,275	3,625	6,410	13,075																															
950	95	198	373	766	1,147	2,209	3,522	6,225	12,698																															
1000	92	193	363	745	1,116	2,149	3,425	6,055	12,351																															
1100	87	183	345	707	1,060	2,041	3,253	5,751	11,730																															
1200	83	174	329	675	1,011	1,947	3,103	5,486	11,190																															
1300	80	167	315	646	968	1,865	2,972	5,254	10,716																															
1400	77	161	302	621	930	1,791	2,855	5,047	10,295																															
1500	74	155	291	598	896	1,726	2,751	4,862	9,918	17,943	29,054																													
1600	71	149	281	578	865	1,667	2,656	4,696	9,578	17,327	28,057																													
1700	69	145	272	559	837	1,613	2,570	4,544	9,269	16,768	27,151																													
1800	67	140	264	542	812	1,564	2,492	4,406	8,986	16,258	26,325																													
1900	65	136	256	526	788	1,519	2,420	4,279	8,727	15,789	25,566																													
2000	63	132	249	512	767	1,477	2,354	4,162	8,488	15,357	24,866																													
2100	62	129	243	499	747	1,439	2,293	4,053	8,267	14,957	24,218																													
2200	60	126	237	486	728	1,403	2,236	3,953	8,062	14,585	23,616																													
2300	59	123	231	475	711	1,369	2,183	3,859	7,870	14,238	23,055																													
2400	57	120	226	464	695	1,338	2,133	3,771	7,691	13,914	22,531																													
2500	56	117	221	454	680	1,309	2,086	3,688	7,523	13,610	22,038																													
2600	55	115	216	444	665	1,282	2,043	3,611	7,365	13,325	21,576																													



Table 12-8 (Metric) Sizing of Medium Pressure Gas Piping

		Gas		Natural								
		Inlet Pressure		13.8 kPa								
		Pressure Drop		10.3 kPa								
		Specific Gravity		0.60								
		Pipe Size, millimeters										
		15	20	25	32	40	50	65	80	100	125	150
Length meters	Capacity in Liters per Second											
	15.2	3.7	7.7	14.4	29.6	44.4	85.5	136.3	240.9			
30.4	2.5	5.3	9.9	20.4	30.5	58.8	93.6	165.6				
45.6	2.0	4.2	8.0	16.4	24.5	47.2	75.2	132.9				
60.8	1.7	3.6	6.8	14.0	21.0	40.4	64.4	113.8				
76.0	1.5	3.2	6.0	12.4	18.6	35.8	57.0	100.8				
91.2	1.4	2.9	5.5	11.2	16.8	32.4	51.7	91.4				
106.4	1.3	2.7	5.0	10.3	15.5	29.8	47.6	84.1				
121.6	1.2	2.5	4.7	9.6	14.4	27.8	44.2	78.2				
136.8	1.1	2.3	4.4	9.0	13.5	26.0	41.5	73.4				
152.0	1.1	2.2	4.2	8.5	12.8	24.6	39.2	69.3				
167.2	1.0	2.1	3.9	8.1	12.1	23.4	37.2	65.8				
182.4	1.0	2.0	3.8	7.7	11.6	22.3	35.5	62.8				
197.6	0.9	1.9	3.6	7.4	11.1	21.3	34.0	60.1				
212.8	0.9	1.8	3.5	7.1	10.6	20.5	32.7	57.8	117.8			
228.0	0.8	1.8	3.3	6.8	10.3	19.8	31.5	55.7	113.5			
243.2	0.8	1.7	3.2	6.6	9.9	19.1	30.4	53.7	109.6			
258.4	0.8	1.7	3.1	6.4	9.6	18.5	29.4	52.0	106.1			
273.6	0.8	1.6	3.0	6.2	9.3	17.9	28.5	50.4	102.9			
288.8	0.7	1.6	2.9	6.0	9.0	17.4	27.7	49.0	99.9			
304.0	0.7	1.5	2.9	5.9	8.8	16.9	26.9	47.6	97.2			
334.4	0.7	1.4	2.7	5.6	8.3	16.1	25.6	45.2	92.3			
364.8	0.7	1.4	2.6	5.3	8.0	15.3	24.4	43.2	88.0			
395.2	0.6	1.3	2.5	5.1	7.6	14.7	23.4	41.3	84.3			
425.6	0.6	1.3	2.4	4.9	7.3	14.1	22.5	39.7	81.0			
456.0	0.6	1.2	2.3	4.7	7.0	13.6	21.6	38.3	78.0	141.2	228.6	
486.4	0.6	1.2	2.2	4.5	6.8	13.1	20.9	36.9	75.3	136.3	220.7	
516.8	0.5	1.1	2.1	4.4	6.6	12.7	20.2	35.7	72.9	131.9	213.6	
547.2	0.5	1.1	2.1	4.3	6.4	12.3	19.6	34.7	70.7	127.9	207.1	
577.6	0.5	1.1	2.0	4.1	6.2	11.9	19.0	33.7	68.7	124.2	201.1	
608.0	0.5	1.0	2.0	4.0	6.0	11.6	18.5	32.7	66.8	120.8	195.6	
638.4	0.5	1.0	1.9	3.9	5.9	11.3	18.0	31.9	65.0	117.7	190.5	
668.8	0.5	1.0	1.9	3.8	5.7	11.0	17.6	31.1	63.4	114.7	185.8	
669.2	0.5	1.0	1.8	3.7	5.6	10.8	17.2	30.4	61.9	112.0	181.4	
729.6	0.5	0.9	1.8	3.6	5.5	10.5	16.8	29.7	60.5	109.5	177.2	
760.0	0.4	0.9	1.7	3.6	5.3	10.3	16.4	29.0	59.2	107.1	173.4	
790.4	0.4	0.9	1.7	3.5	5.2	10.1	16.1	28.4	57.9	104.8	169.7	

Table 12-9 Sizing of Medium Pressure Gas Piping

		Gas								Natural		
		Inlet Pressure								3.0 psi		
		Pressure Drop								1.5 psi		
		Specific Gravity								0.60		
		Pipe Size, inches										
		1/2	3/4	1	1-1/4	1-1/2	2	2-1/2	3	4	5	6
Length feet	Capacity in Cubic Feet of Gas per Hour											
	50	857	1,793	3,377	6,934	10,389	20,008	31,890	56,376			
100	589	1,232	2,321	4,766	7,140	13,752	21,918	38,747				
150	473	990	1,864	3,827	5,734	11,043	17,601	31,115				
200	405	847	1,595	3,275	4,908	9,451	15,064	26,631				
250	359	751	1,414	2,903	4,349	8,377	13,351	23,602				
300	325	680	1,281	2,630	3,941	7,560	12,097	21,385				
350	299	626	1,179	2,420	3,626	6,983	11,129	19,674				
400	278	582	1,096	2,251	3,373	6,496	10,353	18,303				
450	261	546	1,029	2,112	3,165	6,095	9,714	17,173				
500	247	516	972	1,995	2,989	5,757	9,176	16,222				
550	234	490	923	1,895	2,839	5,468	8,715	15,406				
600	224	467	881	1,808	2,709	5,216	8,314	14,698				
650	214	448	843	1,731	2,594	4,995	7,962	14,075	28,709			
700	206	430	810	1,663	2,492	4,799	7,649	13,522	27,581			
750	198	414	780	1,602	2,401	4,623	7,369	13,027	26,570			
800	191	400	754	1,547	2,318	4,465	7,116	12,580	25,658			
850	185	387	729	1,497	2,243	4,321	6,886	12,174	24,831			
900	180	375	707	1,452	2,175	4,189	6,677	11,803	24,074			
950	174	365	687	1,410	2,112	4,068	6,484	11,463	23,380			
1000	170	355	668	1,371	2,055	3,957	6,307	11,149	22,741			
1100	161	337	634	1,302	1,951	3,758	5,990	10,589	21,598			
1200	154	321	605	1,242	1,862	3,585	5,714	10,102	20,605			
1300	147	308	580	1,190	1,783	3,433	5,472	9,674	19,731			
1400	141	296	557	1,143	1,713	3,298	5,257	9,294	18,956			
1500	136	285	536	1,101	1,650	3,178	5,064	8,953	18,262	33,038	53,496	
1600	131	275	518	1,063	1,593	3,069	4,891	8,646	17,635	31,904	51,660	
1700	127	266	501	1,029	1,542	2,970	4,733	8,367	17,066	30,875	49,993	
1800	123	258	486	998	1,495	2,879	4,589	8,112	16,546	29,935	48,471	
1900	120	251	472	969	1,452	2,796	4,457	7,878	16,069	29,072	47,074	
2000	117	244	459	942	1,412	2,720	4,335	7,663	15,629	28,276	45,785	
2100	114	237	447	918	1,375	2,649	4,222	7,463	15,222	27,539	44,593	
2200	111	231	436	895	1,341	2,583	4,117	7,278	14,844	26,855	43,484	
2300	108	226	426	874	1,309	2,522	4,019	7,105	14,491	26,217	42,451	
2400	106	221	416	854	1,279	2,464	3,927	6,943	14,161	25,620	41,485	
2500	103	216	407	835	1,252	2,410	3,842	6,791	13,852	25,060	40,579	
2600	101	211	398	818	1,225	2,360	3,761	6,649	13,561	24,534	39,727	

Table 12-9 (Metric) Sizing of Medium Pressure Gas Piping

		Gas							Natural			
		Inlet Pressure							20.7 kPa			
		Pressure Drop							10.3 kPa			
		Specific Gravity							0.60			
		Pipe Size, millimeters										
		15	20	25	32	40	50	65	80	100	125	150
Length meters	Capacity in Liters per Second											
	15.2	6.7	14.1	26.6	54.5	81.7	157.4	250.9	443.5			
30.4	4.6	9.7	18.3	37.5	56.2	108.2	172.4	304.8				
45.6	3.7	7.8	14.7	30.1	45.1	86.9	138.5	244.8				
60.8	3.2	6.7	12.6	25.8	38.6	74.4	118.5	209.5				
76.0	2.8	5.9	11.1	22.8	34.2	65.9	105.0	185.7				
91.2	2.6	5.4	10.1	20.7	31.0	59.7	95.2	168.2				
106.4	2.4	4.9	9.3	19.0	28.5	54.9	87.6	154.8				
121.6	2.2	4.6	8.6	17.7	26.5	51.1	81.5	144.0				
136.8	2.1	4.3	8.1	16.6	24.9	47.9	76.4	135.1				
152.0	1.9	4.1	7.6	15.7	23.5	45.3	72.2	127.6				
167.2	1.8	3.9	7.3	14.9	22.3	43.0	68.6	121.2				
183.4	1.8	3.7	6.9	14.2	21.3	41.0	65.4	115.6				
197.6	1.7	3.5	6.6	13.6	20.4	39.3	62.6	110.7	225.9			
212.8	1.6	3.4	6.4	13.1	19.6	37.8	60.2	106.4	217.0			
228.0	1.6	3.3	6.1	12.6	18.9	36.4	58.0	102.5	209.0			
243.2	1.5	3.1	5.9	12.2	18.2	35.1	56.0	99.0	201.9			
258.4	1.5	3.0	5.7	11.8	17.6	34.0	54.2	95.8	195.3			
273.6	1.4	3.0	5.6	11.4	17.1	33.0	52.5	92.9	189.4			
288.8	1.4	2.9	5.4	11.1	16.6	32.0	51.0	90.2	183.9			
304.0	1.3	2.8	5.3	10.8	16.2	31.1	49.6	87.7	178.9			
334.4	1.3	2.6	5.0	10.2	15.4	29.6	47.1	83.3	169.9			
364.8	1.2	2.5	4.8	9.8	14.6	28.2	45.0	79.5	162.1			
395.2	1.2	2.4	4.6	9.4	14.0	27.0	43.0	76.1	155.2			
425.6	1.1	2.3	4.4	9.0	13.5	25.9	41.4	73.1	149.1			
456.0	1.1	2.2	4.2	8.7	13.0	25.0	39.8	70.4	143.7			
486.4	1.0	2.2	4.1	8.4	12.5	24.1	38.5	68.0	138.7	251.0		406.4
516.8	1.0	2.1	3.9	8.1	12.1	23.4	37.2	65.8	134.3	242.9		393.3
547.2	1.0	2.0	3.8	7.8	11.8	22.6	36.1	63.8	130.2	235.5		381.3
577.6	0.9	2.0	3.7	7.6	11.4	22.0	35.1	62.0	126.4	228.7		370.3
608.0	0.9	1.9	3.6	7.4	11.1	21.4	34.1	60.3	123.0	222.4		360.2
638.4	0.9	1.9	3.5	7.2	10.8	20.8	33.2	58.7	119.8	216.7		350.8
668.8	0.9	1.8	3.4	7.0	10.6	20.3	32.4	57.3	116.8	211.3		342.1
669.2	0.9	1.8	3.3	6.9	10.3	19.8	31.6	55.9	114.0	206.2		334.0
729.6	0.8	1.7	3.3	6.7	10.1	19.4	30.9	54.6	111.4	201.6		326.4
760.0	0.8	1.7	3.2	6.6	9.8	19.0	30.2	53.4	109.0	197.2		319.2
790.4	0.8	1.7	3.1	6.4	9.6	18.6	29.6	52.3	106.7	193.0		312.5

Table 12-10 Sizing of Medium Pressure Gas Piping

		Gas		Natural								
		Inlet Pressure		5.0 psi								
		Pressure Drop		1.5 psi								
		Specific Gravity		0.60								
		Pipe Size, inches										
		1/2	3/4	1	1-1/4	1-1/2	2	2-1/2	3	4	5	6
Length feet	Capacity in Cubic Feet of Gas per Hour											
	50	1,399	2,925	5,509	11,311	16,947	32,638	52,020	91,962			
100	961	2,010	3,786	7,774	11,648	22,432	35,753	63,205				
150	772	1,614	3,041	6,243	9,353	18,014	28,711	50,756				
200	661	1,381	2,602	5,343	8,005	15,417	24,573	43,441				
250	586	1,224	2,306	4,735	7,095	13,664	21,779	38,501				
300	531	1,109	2,090	4,291	6,429	12,381	19,733	34,884				
350	488	1,021	1,923	3,947	5,914	11,390	18,154	32,093				
400	454	949	1,789	3,672	5,502	10,596	16,889	29,865				
450	426	891	1,678	3,445	5,162	9,942	15,846	28,013				
500	402	842	1,585	3,255	4,876	9,391	14,968	26,461				
550	382	799	1,506	3,091	4,631	8,919	14,216	25,131				
600	365	762	1,436	2,949	4,418	8,509	13,562	23,976				
650	349	730	1,375	2,824	4,231	8,149	12,988	22,960	46,830			
700	335	701	1,321	2,713	4,065	7,828	12,477	22,057	44,990			
750	323	676	1,273	2,614	3,916	7,542	12,020	21,249	43,342			
800	312	653	1,229	2,524	3,781	7,283	11,608	20,520	41,855			
850	302	632	1,190	2,442	3,659	7,048	11,233	19,858	40,504			
900	293	612	1,153	2,368	3,548	6,833	10,891	19,253	39,271			
950	284	595	1,120	2,300	3,446	6,636	10,577	18,698	38,139			
1000	277	578	1,089	2,237	3,351	6,455	10,288	18,187	37,095			
1100	263	549	1,035	2,124	3,183	6,130	9,771	17,273	35,231			
1200	251	524	987	2,027	3,037	5,848	9,321	16,478	33,611			
1300	240	502	945	1,941	2,908	5,600	8,926	15,780	32,186			
1400	231	482	908	1,865	2,794	5,380	8,575	15,160	30,921			
1500	222	464	875	1,796	2,691	5,183	8,261	14,605	29,789	53,892		87,263
1600	214	449	845	1,735	2,599	5,005	7,978	14,103	28,766	52,043		84,269
1700	208	434	818	1,679	2,515	4,844	7,720	13,648	27,838	50,363		81,550
1800	201	421	798	1,628	2,439	4,696	7,485	13,233	26,991	48,830		79,067
1900	195	409	770	1,581	2,368	4,561	7,270	12,851	26,213	47,422		76,787
2000	190	398	749	1,537	2,303	4,436	7,071	12,500	25,495	46,124		74,686
2100	185	387	729	1,497	2,243	4,321	6,886	12,174	24,831	44,923		72,740
2200	181	378	711	1,460	2,188	4,213	6,715	11,871	24,214	43,806		70,932
2300	176	369	694	1,425	2,136	4,113	6,556	11,589	23,639	42,765		69,247
2400	172	360	678	1,393	2,087	4,020	6,406	11,326	23,100	41,792		67,671
2500	168	352	664	1,363	2,042	3,932	6,267	11,078	22,596	40,879		66,193
2600	165	345	650	1,334	1,999	3,849	6,135	10,846	22,121	40,021		64,803

Table 12-10 (Metric) Sizing of Medium Pressure Gas Piping

												Gas		Natural									
												Inlet Pressure		34.5 kPa									
												Pressure Drop		10.3 kPa									
												Specific Gravity		0.60									
												Pipe Size, millimeters											
												15	20	25	32	40	50	65	80	100	125	150	
Length meters	Capacity in Liters per Second																						
	15.2	11.0	23.0	46.3	89.0	133.3	256.8	409.2	723.5														
30.4	7.6	15.8	29.8	61.2	91.6	176.5	281.3	497.2															
45.6	6.1	12.7	23.9	49.1	73.6	141.7	225.9	399.3															
60.8	5.2	10.9	20.5	42.0	63.0	121.3	193.3	341.7															
76.0	4.6	9.6	18.1	37.3	55.8	107.5	171.3	302.9															
91.2	4.2	8.7	16.4	33.8	50.6	97.4	155.2	274.4															
106.4	3.8	8.0	15.1	31.1	46.5	89.6	142.8	252.5															
121.6	3.6	7.5	14.1	28.9	43.3	83.4	132.9	234.9															
136.8	3.4	7.0	13.0	27.1	40.6	78.2	124.7	220.4															
152.0	3.2	6.6	12.5	25.6	38.4	73.9	117.8	208.2															
167.2	3.0	6.3	11.8	24.3	36.4	70.2	111.8	197.7															
182.4	2.9	6.0	11.3	23.2	34.8	66.9	106.7	188.6															
197.6	2.7	5.7	10.8	22.2	33.3	64.1	102.2	180.6	368.4														
212.8	2.6	5.5	10.4	21.3	32.0	61.6	98.2	173.5	353.9														
228.0	2.5	5.3	10.0	20.6	30.8	59.3	94.6	167.2	341.0														
243.2	2.5	5.1	9.7	19.9	29.7	57.3	91.3	161.4	329.3														
258.4	2.4	5.0	9.4	19.2	28.8	55.4	88.4	156.2	318.6														
273.6	2.3	4.8	9.1	18.6	27.9	53.8	85.7	151.5	308.9														
288.0	2.2	4.7	8.8	18.1	27.1	52.2	83.2	147.1	300.0														
304.0	2.2	4.6	8.6	17.6	26.4	50.8	80.9	143.1	291.8														
334.4	2.1	4.3	8.1	16.7	25.0	48.2	76.9	135.9	277.2														
364.8	2.0	4.1	7.8	15.9	23.9	46.0	73.3	129.6	264.4														
395.2	1.9	3.9	7.4	15.3	22.9	44.1	70.2	124.1	253.2														
425.6	1.8	3.8	7.1	14.7	22.0	42.3	67.5	119.3	243.3														
456.0	1.7	3.7	6.9	14.1	21.2	40.8	65.0	114.9	234.3	424.0	686.5												
486.4	1.7	3.5	6.6	13.6	20.4	39.4	62.8	111.0	226.3	409.4	662.9												
516.8	1.6	3.4	6.4	13.2	19.8	38.1	60.7	107.4	219.0	396.2	641.6												
547.2	1.6	3.3	6.2	12.8	19.2	36.9	58.9	104.1	212.3	384.1	622.0												
577.6	1.5	3.2	6.1	12.4	18.6	35.9	57.2	101.1	206.2	373.1	604.1												
608.0	1.5	3.1	5.9	12.1	18.1	34.9	55.6	98.3	200.6	362.9	587.6												
638.4	1.5	3.0	5.7	11.8	17.6	34.0	54.2	95.8	195.3	353.4	572.2												
668.8	1.4	3.0	5.6	11.5	17.2	33.1	52.8	93.4	190.5	344.6	558.0												
699.2	1.4	2.9	5.5	11.2	16.8	32.4	51.6	91.2	186.0	336.4	544.8												
729.6	1.4	2.8	5.3	11.0	16.4	31.6	50.4	89.1	181.7	328.8	532.4												
760.0	1.3	2.8	5.2	10.7	16.1	30.9	49.3	87.2	177.8	321.6	520.7												
790.4	1.3	2.7	5.1	10.5	15.7	30.3	48.3	85.3	174.0	314.8	509.8												

Table 12-11 Low-Pressure LPG Pipe Sizing

		Gas		Undiluted LPG		
		Inlet Pressure		11 in. w.c.		
		Pressure Drop		0.5 in. w.c.		
Pipe Size, inches						
	1/2	3/4	1	1-1/4	1-1/2	2
Length feet	Maximum Capacity in Thousands of Btu per Hour					
	10	275	567	1071	2205	3307
20	189	393	732	1496	2299	4331
30	152	315	590	1212	1858	3465
40	129	267	504	1039	1559	2992
50	114	237	448	913	1417	2646
60	103	217	409	834	1275	2394
70	96	196	378	771	1181	2205
80	89	185	346	724	1086	2047
90	83	173	322	677	1023	1921
100	78	162	307	630	976	1811
125	69	146	275	567	866	1606
150	63	132	252	511	787	1496
200	55	112	213	440	675	1280

Table 12-11 (Metric) Low-Pressure LPG Pipe Sizing

		Gas		Undiluted LPG		
		Inlet Pressure		279 mm w.c.		
		Pressure Drop		12.7 mm w.c.		
Pipe Size, millimeters						
	15	20	25	32	40	50
Length meters	Maximum Capacity in Thousands of Watts					
	3.0	80.6	166.1	313.8	646.1	969.0
6.1	55.4	115.2	214.5	438.3	673.6	1269.0
9.1	44.5	92.3	172.9	355.1	544.4	1015.2
12.2	37.8	78.2	147.7	304.4	456.8	876.7
15.2	33.4	69.4	131.3	267.5	415.2	775.3
18.2	30.2	63.6	119.8	244.4	373.6	701.4
21.3	28.1	57.4	110.8	225.9	346.0	646.1
24.3	26.1	54.2	101.4	212.1	318.2	600.0
27.4	24.3	50.7	94.4	198.4	299.7	562.9
30.4	22.9	47.5	90.0	184.6	286.0	530.6
38.0	20.2	42.8	80.6	166.1	253.7	470.6
45.6	18.5	38.7	73.8	149.7	230.6	438.3
60.8	16.1	32.8	62.4	128.9	197.8	369.2

Table 12-12 Sizing of IPS Pipe for Undiluted LPG

		Gas		Undiluted LPG								
		Inlet Pressure		10.0 psi								
		Pressure Drop		3.0 psi								
		Specific Gravity		1.52								
		Pipe Size, inches										
		1/2	3/4	1	1-1/4	1-1/2	2	2-1/2	3	4	5	6
Length feet	Maximum Delivery Capacity in Cubic Feet per Hour											
	50	1,000	2,070	3,899	8,005	11,994	23,100	36,818	65,088			
100	690	1,423	2,680	5,502	8,244	15,877	25,305	44,734				
150	550	1,142	2,152	4,418	6,620	12,750	20,321	35,923				
200	470	978	1,842	3,782	5,666	10,912	17,392	30,746				
250	420	867	1,632	3,351	5,022	9,671	15,414	27,243				
300	390	785	1,479	3,037	4,550	8,763	13,966	24,690				
350	350	722	1,361	2,794	4,186	8,062	12,849	22,714				
400	325	672	1,266	2,599	3,894	7,500	11,953	21,131				
450	300	631	1,188	2,439	3,654	7,037	11,215	19,827				
500	285	596	1,122	2,303	3,451	6,647	10,594	18,728				
550	272	566	1,066	2,188	3,278	6,313	10,062	17,787				
600	260	540	1,017	2,087	3,127	6,023	9,599	16,969				
650	250	517	973	1,999	2,995	5,767	9,192	16,250	33,145			
700	240	496	935	1,920	2,877	5,541	8,311	15,611	31,842			
750	230	478	901	1,850	2,772	5,338	8,507	15,040	30,676			
800	222	462	870	1,786	2,676	5,155	8,215	14,523	29,623			
850	215	447	842	1,729	2,590	4,988	7,950	14,055	28,667			
900	208	433	816	1,676	2,511	4,836	7,708	13,627	27,795			
950	202	421	793	1,628	2,439	4,697	7,486	13,234	26,993			
1,000	198	409	771	1,583	2,372	4,568	7,281	12,872	26,255			
1,100	188	389	732	1,504	2,253	4,339	6,915	12,225	24,935			
1,200	180	371	699	1,434	2,149	4,139	6,597	11,663	23,789			
1,300	171	355	669	1,374	2,058	3,964	6,318	11,169	22,780			
1,400	164	341	643	1,320	1,977	3,808	6,069	10,730	21,885			
1,500	158	329	619	1,271	1,905	3,669	5,847	10,337	21,083	38,143	61,762	
1,600	152	317	598	1,228	1,839	3,543	5,646	9,982	20,360	36,834	59,643	
1,700	148	307	579	1,138	1,780	3,428	5,464	9,660	19,705	35,645	57,718	
1,800	143	298	561	1,152	1,726	3,324	5,298	9,366	19,103	34,560	55,961	
1,900	139	289	545	1,119	1,676	3,228	5,145	9,096	18,552	33,564	54,348	
2,000	136	281	530	1,088	1,630	3,140	5,004	8,847	18,045	32,645	52,860	
2,100	133	274	516	1,060	1,588	3,058	4,874	8,616	17,575	31,795	51,483	
2,200	130	267	503	1,033	1,548	2,982	4,753	8,402	17,138	31,005	50,204	
2,300	127	261	491	1,009	1,512	2,911	4,640	8,203	16,731	30,268	49,011	
2,400	124	255	480	986	1,477	2,845	4,534	8,016	16,350	29,579	47,895	
2,500	121	249	470	964	1,445	2,783	4,435	7,841	15,993	28,933	46,849	
2,600	118	244	460	944	1,415	2,724	4,342	7,676	15,657	28,325	45,865	

Table 12-12 (Metric) Sizing of IPS Pipe for Undiluted LPG

		Gas								Undiluted LPG	
		Inlet Pressure								68.9 kPa	
		Pressure Drop								20.7 kPa	
		Specific Gravity								1.52	
Pipe Size, millimeters											
	15	20	25	32	40	50	65	80	100	125	150
Length meters	Maximum Delivery Capacity in Liters per Second										
	15.2	8.0	16.6	31.2	64.0	96.0	184.8	294.5	520.7		
30.4	5.5	11.4	21.4	44.0	66.0	127.0	202.4	357.9			
45.6	4.4	9.1	17.2	35.3	53.0	102.0	162.6	287.4			
60.8	3.8	7.8	14.7	30.3	45.3	87.3	139.1	246.0			
76.0	3.4	6.9	13.1	26.8	40.2	77.4	123.3	218.0			
91.2	3.0	6.3	11.8	24.3	36.4	70.1	111.7	197.5			
106.4	2.8	5.8	10.9	22.4	33.5	64.5	102.8	181.7			
121.6	2.6	5.4	10.1	20.8	31.2	60.0	95.6	169.1			
136.8	2.4	5.1	9.5	19.5	29.2	56.3	89.7	158.6			
152.0	2.3	4.8	9.0	18.4	27.6	53.2	84.8	149.8			
167.2	2.2	4.5	8.5	17.5	26.2	50.5	80.5	142.3			
182.4	2.1	4.3	8.1	16.7	25.0	48.2	76.8	135.8			
197.6	2.0	4.1	7.8	16.0	24.0	46.1	73.5	130.0	265.2		
212.8	1.9	4.0	7.5	15.4	23.0	44.3	70.7	124.9	254.7		
228.0	1.8	3.8	7.2	14.8	22.2	42.7	68.1	120.3	245.4		
243.2	1.8	3.7	7.0	14.3	21.4	41.2	65.7	116.2	237.0		
258.4	1.7	3.6	6.7	13.8	20.7	39.9	63.6	112.4	229.3		
273.6	1.7	3.5	6.5	13.4	20.1	38.7	61.7	109.0	222.4		
288.8	1.6	3.4	6.3	13.0	19.5	37.6	60.0	105.9	215.9		
304.0	1.6	3.3	6.2	12.7	19.0	36.5	58.2	103.0	210.0		
334.4	1.5	3.1	5.9	12.0	18.0	34.7	55.3	97.8	199.5		
364.8	1.4	3.0	5.6	11.5	17.2	33.1	52.8	93.3	190.3		
395.2	1.4	2.8	5.4	11.0	16.5	31.7	50.5	89.4	182.2		
425.6	1.3	2.7	5.1	10.6	15.8	30.5	48.6	85.8	175.1		
456.0	1.3	2.6	5.0	10.2	15.2	29.4	46.8	82.7	168.7	305.1	494.1
486.4	1.2	2.5	4.8	9.8	14.7	28.3	45.2	79.9	162.9	294.7	477.1
516.8	1.2	2.5	4.6	9.1	14.2	27.4	43.7	77.3	157.6	285.2	461.7
547.2	1.1	2.4	4.5	9.2	13.8	26.6	42.4	74.9	152.8	276.5	447.7
577.6	1.1	2.3	4.4	9.0	13.4	25.8	41.2	72.8	148.4	268.5	434.8
608.0	1.1	2.2	4.2	8.7	13.0	25.1	40.0	70.8	144.4	261.2	422.9
638.4	1.1	2.2	4.1	8.5	12.7	24.5	39.0	68.9	140.6	254.4	411.9
668.8	1.0	2.1	4.0	8.3	12.4	23.9	38.0	67.2	137.1	248.1	401.6
699.2	1.0	2.1	3.9	8.1	12.1	23.3	37.1	65.6	133.8	242.1	392.1
729.6	1.0	2.0	3.8	7.9	11.8	22.8	36.3	64.1	130.8	236.6	383.2
760.0	1.0	2.0	3.8	7.7	11.6	22.3	35.5	62.7	127.9	231.5	374.8
790.4	0.9	2.0	3.7	7.6	11.3	21.8	34.7	61.4	125.3	226.6	366.9



**TABLE 12-13**  
**Capacities of Listed Metal Appliance Connectors for Use with Gas Pressures Less Than an 8 Inch Water Column**

Semi-rigid Connector O.D, Inches	Flexible Connector Nominal I.D., Inches	Capacities for Various Lengths, in Thousands Btu/h (Based on Pressure Drop of 0.2 in. Water Column Natural Gas of 1100 Btu/cu. ft.)							
		1 foot	1-1/2 feet	2 feet	2-1/2 feet	3 feet	4 feet	5 feet	6 feet
All Gas Appliances				Ranges and Dryers Only					
3/8	1/4	28	23	20	19	17			
1/2	3/8	66	54	47	44	41			
5/8	1/2	134	110	95	88	82	72	63	57
-	3/4	285	233	202	188	174			
-	1	567	467	405	378	353			

Notes:

1. Flexible connector listings are based on the nominal internal diameter.
2. Semi-rigid connector listings are based on the outside diameter.
3. Gas connectors are certified by the testing agency as complete assemblies, including the fittings and valves. Capacities shown are based on the use of fittings and valves supplied with the connector.
4. Capacities for LPG are 1.6 times the natural gas capacities shown.

Example: Capacity of a 1/4 in. flexible connector 1 foot long is 28,000 x 1.6 = 44,800 Btu/h.

**TABLE 12-13 (Metric)**  
**Capacities of Listed Metal Appliance Connectors for Use with Gas Pressures Less Than a 203 mm Water Column**

Semi-rigid Connector O.D, mm	Flexible Connector Nominal I.D., mm	Capacities for Various Lengths, in Thousands Watts (Based on Pressure Drop of 50 Pa Water Column Natural Gas of 11.4 Watt-hours/L)							
		305 mm	457 mm	610 mm	762 mm	914 mm	1219 mm	1524 mm	1829 mm
All Gas Appliances				Ranges and Dryers Only					
10	6.4	8.2	6.7	5.9	5.6	5			
15	9.5	19.3	15.8	13.8	12.9	12			
18	12.7	39.3	32.2	27.8	25.8	24	21.1	18.5	16.7
	19.1	83.5	68.3	59.2	55.1	51			
	25.9	166.1	136.8	118.7	110.8	103.4			

Notes: See Table 12-13 (English units).

Example: Capacity of a 6.4 mm flexible connector 305 mm long is 8204 x 1.6 = 13,126.4 W.

**TABLE 12-14**  
**Capacities of Listed Metal Appliance Connectors for Use with Gas Pressures Not Less Than an 8 Inch Water Column**

Semi-rigid Connector O.D, Inches	Flexible Connector Nominal I.D., Inches	Capacities for Various Lengths, in Thousands Btu/h (Based on Pressure Drop of 0.2" Water Column Natural Gas of 1100 Btu/cu. ft.)							
		1 foot	1-1/2 feet	2 feet	2-1/2 feet	3 feet	4 feet	5 feet	6 feet
All Gas Appliances					Ranges and Dryers Only				
3/8	1/4	40	33	29	27	25			
1/2	3/8	93	76	66	62	58			
5/8	1/2	189	155	134	125	116	101	90	80
	3/4	404	330	287	266	244			
	1	803	661	573	534	500			

Notes:

1. Flexible connector listings are based on the nominal internal diameter.
2. Semi-rigid connector listings are based on the outside diameter.
3. Gas connectors are certified by the testing agency as complete assemblies, including the fittings and valves. Capacities shown are based on the use of fittings and valves supplied with the connector.
4. Capacities for LPG are 1.6 times the natural gas capacities shown.

Example: Capacity of a 1/4 in. flexible connector one (1) foot long is 40,000 x 1.6 = 64,000 Btu/h.

**TABLE 12-14 (Metric)**  
**Capacities of Listed Metal Appliance Connectors for Use with Gas Pressures Not Less Than a 203 mm Water Column**

Semi-rigid Connector O.D, mm	Flexible Connector Nominal I.D., mm	Capacities for Various Lengths, in Thousands Watts (Based on Pressure Drop of 50 Pa mm Water Column Natural Gas of 11.4 Watt-hours/L)							
		305 mm	457 mm	610 mm	762 mm	914 mm	1219 mm	1524 mm	1829 mm
All Gas Appliances					Ranges and Dryers Only				
10	6.4	11.7	9.7	8.5	7.9	7.3			
15	9.5	27.3	22.3	19.3	18.2	17.0			
18	12.7	55.4	45.4	39.3	36.6	34.0	29.6	26.4	23.4
	19.1	118.4	96.7	84.1	77.9	71.5			
	25.4	235.3	193.7	167.9	156.5	146.5			

Notes: See Table 12-14 (English units).

Example: Capacity of a 6.4 mm flexible connector 0.3 m long is 11,720W x 1.6 = 18,752 W.

**Table 12-15**  
**Copper Tube – Low Pressure**  
 Maximum Delivery Capacity\* of Cubic Feet of Gas Per Hour of Copper Tube Carrying Natural Gas of 0.60\*\* Specific Gravity at Low Pressure (Less than 14 inches Water Column) Based on Pressure Drop of 0.50 Inch Water Column

Length of Tube, feet	Outside Diameter of Tube, inches						
	3/8 (10 mm)	1/2 (15 mm)	5/8 (18 mm)	3/4 (20 mm)	7/8 (22 mm)	1-1/8 (28 mm)	1-3/8 (34 mm)
10	24	50	101	176	250	535	963
20	17	34	69	121	172	368	662
30	13	27	56	97	138	295	531
40	11	23	48	83	118	253	455
50	10	21	42	74	105	224	403
60	9.1	19	38	67	95	203	365
70	8.4	17	35	62	84	197	336
80	7.8	16	33	57	81	174	313
90	7.3	15	31	54	76	163	293
100	6.9	14	29	51	72	154	277
125	6.1	13	26	45	64	136	245
150	5.6	11	23	41	58	124	222
175	5.1	11	21	38	53	114	205
200	4.8	10	20	35	50	106	190
250	4.2	8.7	18	31	44	94	169

\*Includes 20% factor for fittings.  
 \*\*For other pressure drop values see Table 12-16.

**Table 12-16**  
**Specific Gravity**  
 Multipliers to Be Used with Copper Tube When Specific Gravity of Gas is other than 0.60.

Specific Gravity	Multiplier	Specific Gravity	Multiplier
.35	1.31	1.00	.78
.40	1.23	1.10	.74
.45	1.16	1.20	.71
.50	1.10	1.30	.68
.55	1.04	1.40	.66
.60	1.00	1.50	.63
.65	.96	1.60	.59
.70	.93	1.70	.58
.75	.90	1.80	.56
.80	.87	1.90	.56
.85	.84	2.00	.55
.90	.82	2.10	.54

Adjustment for a gas with an average specific gravity (relative density) other than 0.60 is achieved by multiplying the CFH values of Tables 12-15, 12-17, or 12-18 by the appropriate multiplier.

**Table 12-17**  
**Copper Tube – Medium Pressure**  
 Maximum Delivery Capacity\* of Cubic Feet of Gas Per Hour of Copper Tube Carrying Natural Gas of 0.60\*\* Specific Gravity at Medium Pressure (2.0 psig) Based on Pressure Drop of 1.0 psig:

Length of Tube, feet	Outside Diameter of Tube, inches						
	3/8 (10 mm)	1/2 (15 mm)	5/8 (18 mm)	3/4 (20 mm)	7/8 (22 mm)	1-1/8 (28 mm)	1-3/8 (34 mm)
10	222	458	932	1629	2,311	4,937	8,889
20	153	315	641	1120	1,589	3,393	6,109
30	123	253	515	899	1,276	2,725	4,906
40	105	216	440	770	1,092	2,332	4,199
50	93	192	390	682	968	2,067	3,721
60	84	174	354	618	877	1,873	3,372
70	78	160	325	569	807	1,723	3,102
80	72	149	303	529	750	1,603	2,886
90	68	140	254	496	704	1,504	2,708
100	64	132	268	469	665	1,421	2,558
125	57	117	238	415	589	1,259	2,267
150	51	106	215	376	534	1,141	2,054
175	47	97	198	346	491	1,050	1,890
200	44	91	184	322	457	976	1,758
250	39	80	163	286	405	865	1,558

\*Includes 20% factor for fittings.  
 \*\*For other pressure drop values see Table 12-16.

**Table 12-18**  
**Copper Tube – High Pressure**  
 Maximum Delivery Capacity\* of Cubic Feet of Gas Per Hour of Copper Tube Carrying Natural Gas of 0.60\*\* Specific Gravity at High Pressure (5.0 psig) Based on Pressure Drop of 3.50 psig:

Length of Tube, feet	Outside Diameter of Tube, inches						
	3/8 (10 mm)	1/2 (15 mm)	5/8 (18 mm)	3/4 (20 mm)	7/8 (22 mm)	1-1/8 (28 mm)	1-3/8 (34 mm)
10	462	954	1,941	3,392	4,812	10,279	18,504
20	318	656	1,334	2,331	3,307	7,064	12,718
30	255	527	1,071	1,872	2,656	5,673	10,213
40	218	451	917	1,602	2,273	4,855	8,741
50	194	399	812	1,420	2,015	4,303	7,747
60	175	362	736	1,287	1,825	3,899	7,019
70	161	333	677	1,184	1,679	3,587	6,458
80	150	310	630	1,101	1,562	3,337	6,008
90	141	291	591	1,033	1,466	3,131	5,637
100	133	274	558	976	1,385	2,958	5,324
125	118	243	495	865	1,227	2,621	4,719
150	107	220	448	784	1,112	2,375	4,276
175	98	203	413	721	1,023	2,185	3,934
200	91	189	384	671	952	2,033	3,659
250	81	167	340	594	843	1,802	3,243

\*Includes 20% factor for fittings.  
 \*\*For other pressure drop values see Table 12-16.

Table 12-19 Corrugated Stainless Steel Tubing (CSST)

		Gas				Natural						
		Inlet Pressure				0.5 psi or less						
		Pressure Drop				0.5 in.w.c.						
		Specific Gravity				0.60						
		Tube Size (EHD)*										
Flow Designation		13	15	18	19	23	25	30	31	37	46	62
Length feet	Maximum Capacity in Cubic Feet of Gas per Hour											
5	46	63	115	134	225	270	471	546	895	1,790	4,142	
10	32	44	82	95	161	192	330	383	639	1,261	2,934	
15	25	35	66	77	132	157	267	310	524	1,027	2,398	
20	22	31	58	67	116	137	231	269	456	888	2,078	
25	19	27	52	60	104	122	206	240	409	793	1,860	
30	18	25	47	55	96	112	188	218	374	723	1,698	
40	15	21	41	47	83	97	162	188	325	625	1,472	
50	13	19	37	42	75	87	144	168	292	559	1,317	
60	12	17	34	38	68	80	131	153	267	509	1,203	
70	11	16	31	36	63	74	121	141	248	471	1,114	
80	10	15	29	33	60	69	113	132	232	440	1,042	
90	10	14	28	32	57	65	107	125	219	415	983	
100	9	13	26	30	54	62	101	118	208	393	933	
150	7	10	20	23	42	48	78	91	171	320	762	
200	6	9	18	21	38	44	71	82	148	277	661	
250	5	8	16	19	34	39	63	74	133	247	591	
300	5	7	15	17	32	36	57	67	95	226	540	

Note:  
 Table includes losses for four 90 degree bends and two end fittings. Tubing runs with larger numbers of bends and/or fittings shall be increased by an equivalent length of tubing to the following equation:  $L = 1.3n$ , where  $L$  is additional length (ft.) of tubing and  $n$  is the number of additional fittings and/or bends.  
 \*EHD = Equivalent Hydraulic Diameter, which is a measure of the relative hydraulic efficiency between different tubing sizes. The greater the value of EHD, the greater the gas capacity of the tubing.

**Table 12-20 Corrugated Stainless Steel Tubing (CSST)**

		Gas		Natural							
		Inlet Pressure		0.5 psi or less							
		Pressure Drop		3.0 in. w.c.							
		Specific Gravity		0.60							
		Tube Size (EHD)*									
Flow Designation	13	15	18	19	23	25	30	31	37	46	62
Length feet	Maximum Capacity in Cubic Feet of Gas per Hour										
5	120	160	277	327	529	649	1,182	1,365	2,141	4,428	10,103
10	83	112	197	231	380	462	828	958	1,528	3,199	7,156
15	67	90	161	189	313	379	673	778	1,254	2,541	5,848
20	57	78	140	164	273	329	580	672	1,090	2,197	5,069
25	51	69	125	147	245	295	518	599	978	1,963	4,536
30	46	63	115	134	225	270	471	546	895	1,790	4,142
40	39	54	100	116	196	234	407	471	778	1,548	3,590
50	35	48	89	104	176	210	363	421	698	1,383	3,213
60	32	44	82	95	161	192	330	383	639	1,261	2,934
70	29	41	76	88	150	178	306	365	593	1,166	2,717
80	27	38	71	82	141	167	285	331	555	1,090	2,543
90	26	36	67	77	133	157	268	311	524	1,027	2,398
100	24	34	63	73	126	149	254	295	498	974	2,276
150	19	27	52	60	104	122	206	240	409	793	1,860
200	17	23	45	52	91	106	178	207	355	686	1,612
250	15	21	40	46	82	95	159	184	319	613	1,442
300	13	19	37	42	75	87	144	168	234	559	1,317

Note:

Table includes losses for four 90-degree bends and two end fittings. Tubing runs with larger numbers of bends and/or fittings shall be increased by an equivalent length of tubing to the following equation:  $L = 1.3n$ , where  $L$  is additional length (ft) of tubing and  $n$  is the number of additional fittings and/or bends.

\*EHD = Equivalent Hydraulic Diameter, which is a measure of the relative hydraulic efficiency between different tubing sizes. The greater the value of EHD, the greater the gas capacity of the tubing.

**Table 12-21 Corrugated Stainless Steel Tubing (CSST)**

		Gas		Natural							
		Inlet Pressure		0.5 psi or less							
		Pressure Drop		6.0 in.w.c.							
		Specific Gravity		0.60							
		Tube Size (EHD)*									
Flow Designation	13	15	18	19	23	25	30	31	37	46	62
Length feet	Maximum Capacity in Cubic Feet of Gas per Hour										
5	173	229	389	461	737	911	1,687	1,946	3,000	6,282	14,263
10	120	160	277	327	529	649	1,182	1,365	2,141	4,428	10,103
15	96	130	227	267	436	532	960	1,110	1,758	3,607	8,257
20	83	112	197	231	380	462	828	958	1,528	3,119	7,156
25	74	99	176	207	342	414	739	855	1,371	2,786	6,404
30	67	90	161	189	313	379	673	778	1,254	2,541	5,848
40	57	78	140	164	273	329	580	672	1,090	2,197	5,069
50	51	69	125	147	245	295	518	599	978	1,963	4,536
60	46	63	115	134	225	270	471	546	895	1,790	4,142
70	42	58	106	124	209	250	435	505	830	1,656	3,837
80	39	54	100	116	196	234	407	471	778	1,548	3,590
90	37	51	94	109	185	221	383	444	735	1,458	3,386
100	35	48	89	104	176	210	363	421	698	1,383	3,213
150	28	39	73	85	145	172	294	342	573	1,126	2,626
200	24	34	63	73	126	149	254	295	498	974	2,276
250	21	30	57	66	114	134	226	263	447	870	2,036
300	19	27	52	60	104	122	206	240	409	793	1,860

Note:  
 Table includes losses for four 90-degree bends and two end fittings. Tubing runs with larger numbers of bends and/or fittings shall be increased by an equivalent length of tubing to the following equation:  $L = 1.3n$ , where  $L$  is additional length (ft) of tubing and  $n$  is the number of additional fittings and/or bends.  
 \*EHD = Equivalent Hydraulic Diameter, which is a measure of the relative hydraulic efficiency between different tubing sizes. The greater the value of EHD, the greater the gas capacity of the tubing.

**Table 12-22 Corrugated Stainless Steel Tubing (CSST)**

		Gas						Natural			
		Inlet Pressure						2.0 psi			
		Pressure Drop						1.0 in.w.c.			
		Specific Gravity						0.60			
		Tube Size (EHD)*									
Flow Designation	13	15	18	19	23	25	30	31	37	46	62
Length feet	Maximum Capacity in Cubic Feet of Gas per Hour										
10	270	353	587	700	1,098	1,372	2,592	2,986	4,509	9,599	21,637
25	166	220	374	444	709	876	1,620	1,869	2,887	6,041	13,715
30	151	200	342	405	650	801	1,475	1,703	2,642	5,509	12,526
40	129	172	297	351	567	696	1,273	1,470	2,297	4,763	10,855
50	115	154	266	314	510	624	1,135	1,311	2,061	4,255	9,715
75	93	124	218	257	420	512	922	1,066	1,692	3,467	7,940
80	89	120	211	249	407	496	892	1,031	1,639	3,355	7,689
100	79	107	189	222	366	445	795	920	1,471	2,997	6,881
150	64	87	155	182	302	364	646	748	1,207	2,442	5,624
200	55	75	135	157	263	317	557	645	1,049	2,111	4,874
250	49	67	121	141	236	284	497	576	941	1,886	4,362
300	44	61	110	129	217	260	453	525	862	1,720	3,983
400	38	52	96	111	189	225	390	453	749	1,487	3,452
500	34	46	86	100	170	202	348	404	552	1,329	3,089

Notes:

Table includes losses for four 90-degree bends and two end fittings. Tubing runs with larger numbers of bends and/or fittings shall be increased by an equivalent length of tubing to the following equation:  $L = 1.3n$ , where  $L$  is additional length (ft.) of tubing and  $n$  is the number of additional fittings and/or bends.

\*EHD = Equivalent Hydraulic Diameter, which is a measure of the relative hydraulic efficiency between different tubing sizes. The greater the value of EHD, the greater the gas capacity of the tubing.

Table 12-23 Corrugated Stainless Steel Tubing (CSST)

		Gas						Natural			
		Inlet Pressure						5.0 psi			
		Pressure Drop						3.5 in. w.c.			
		Specific Gravity						0.60			
		Tube Size (EHD)*									
Flow Designation	13	15	18	19	23	25	30	31	37	46	62
Length feet	Maximum Capacity in Cubic Feet of Gas per Hour										
10	523	674	1,084	1,304	1,995	2,530	4,923	5,659	8,295	18,080	40,353
25	322	420	691	827	1,289	1,616	3,077	3,543	5,311	11,378	25,580
30	292	382	632	755	1,181	1,478	2,803	3,228	4,860	10,377	23,361
40	251	329	549	654	1,031	1,284	2,418	2,786	4,225	8,972	20,246
50	223	293	492	586	926	1,151	2,157	2,486	3,791	8,015	18,119
75	180	238	403	479	763	944	1,752	2,021	3,112	6,530	14,809
80	174	230	391	463	740	915	1,694	1,955	3,016	6,320	14,341
100	154	205	350	415	665	820	1,511	1,744	2,705	5,646	12,834
150	124	166	287	339	548	672	1,228	1,418	2,221	4,600	10,489
200	107	143	249	294	478	584	1,060	1,224	1,931	3,977	9,090
250	95	128	223	263	430	524	945	1,092	1,732	3,553	8,135
300	86	116	204	240	394	479	860	995	1,585	3,240	7,430
400	74	100	177	208	343	416	742	858	1,378	2,802	6,439
500	66	89	159	186	309	373	662	766	1,035	2,503	5,762

Notes:

1. Table does not include effect of pressure drop across line regulator. Where regulator loss exceeds 1 psi, do not use this table. Consult with regulator manufacturer for pressure drops and capacity factors. Pressure drop across regulator may vary with the flow rate.
2. CAUTION: Capacities shown in table may exceed maximum capacity of selected regulator. Consult with tubing manufacturer for guidance.
3. Table includes losses for four 90-degree bends and two end fittings. Tubing runs with larger numbers of bends and/or fittings shall be increased by an equivalent length of tubing to the following equation:  $L = 1.3n$ , where  $L$  is additional length (ft.) of tubing and  $n$  is the number of additional fittings and/or bends.

\*EHD = Equivalent Hydraulic Diameter, which is a measure of the relative hydraulic efficiency between different tubing sizes. The greater the value of EHD, the greater the gas capacity of the tubing.





# CHAPTER 13

## HEALTH CARE FACILITIES AND MEDICAL GAS AND VACUUM SYSTEMS

### Part I – Special Requirements for Health Care Facilities.

#### 1301.0 Application.

**1301.1** Construction and equipment requirements shall be applied only to new construction and new equipment, except as modified in individual chapters. Only the altered, renovated, or modernized portion of an existing system or individual component shall be required to meet the installation and equipment requirements stated in this standard. If the alteration, renovation, or modernization adversely impacts existing performance requirements of a system or component, additional upgrading shall be required. [NFPA 99 1.3.2]

**1301.2** This chapter applies to the special fixtures and systems in health care facilities and to the special plumbing requirements for such facilities. Other plumbing in such facilities shall comply with other applicable sections of the code.

#### 1302.0 Medical Gas and Vacuum Piping Systems – Installation Requirements.

The installation of medical gas and vacuum piping systems shall be in accordance with the requirements of this chapter and/or the appropriate standards adopted by the Authority Having Jurisdiction. For additional standards see Table 14-1.

**1302.1** The installation of individual components shall be made in accordance with the instructions of the manufacturer. Such instructions shall include directions and information deemed by the manufacturer to be adequate for attaining proper operation, testing, and maintenance of the medical gas and vacuum systems. Copies of manufacturer's instructions shall be left with the system owner. [NFPA 99 5.1.10.6.9.1, 5.1.10.6.9.2, 5.1.10.6.9.3]

**1302.2** The installation of medical gas and vacuum systems shall be made by qualified, competent technicians who are experienced in making such installations. Installers of medical gas and vacuum systems shall meet the requirements of ANSI/ASSE Standard 6010, *Professional Qualification Standard for Medical Gas and Vacuum System Installers*. [NFPA 99 5.1.10.6.11.1, 5.1.10.6.11.2]

**1302.3** Brazing shall be performed by individuals who are qualified under the provisions of 1311.6. [NFPA 99 5.1.10.6.11.3]

**1302.4** Prior to any installation work, the installer of medical gas and vacuum piping shall provide and maintain documentation on the job site for the qualification of brazing procedures and individual brazers that is required under 1311.6. [NFPA 99 5.1.10.6.11.4]

#### 1303.0 Protrusions from Walls.

**1303.1** Drinking fountain control valves shall be flush-mounted or fully recessed when installed in corridors or other areas where patients may be transported on a gurney, bed, or wheelchair.

**1303.2** Piping exposed in corridors and other areas where subject to physical damage from the movement of carts, stretchers, portable equipment, or vehicles shall be protected. [NFPA 99 5.1.10.6.2.1]

#### 1304.0 Psychiatric Patient Rooms.

Piping and drain traps in psychiatric patient rooms shall be concealed. Fixtures and fittings shall be resistant to vandalism. [NFPA 101]

#### 1305.0 Locations for Ice Storage.

Ice makers or ice storage containers shall be located in nursing stations or similarly supervised areas to minimize potential contamination. [See NFPA 101]

#### 1306.0 Sterilizers.

**1306.1 General.** The requirements of this section apply to sterilizers and bedpan steamers. Such equipment shall be installed in accordance with this code and the manufacturer's installation instructions.

#### 1306.2 Indirect Waste Connections.

Waste drainage from sterilizers and bedpan steamers shall be connected to the sanitary drainage system through an air gap in accordance with this chapter and Chapter 8. The size of indirect waste piping shall not be less than the size of the drain connection on the fixture. Each such indirect waste pipe shall not exceed fifteen (15) feet (4572 mm) in length and shall be separately piped to a receptor. Such receptors shall be located in the same room as the equipment served. Except for bedpan steamers, such indirect waste pipes shall not require traps. A trap having a minimum seal of three (3) inches (80 mm) shall be provided in the indirect waste pipe for a bedpan steamer.

**1307.0 Vapor Vents and Stacks for Sterilizers.**

**1307.1 General.** When a sterilizer has provision for a vapor vent and such a vent is required by the manufacturer, the vent shall be extended to the outdoors above the roof. Sterilizer vapor vents shall be installed in accordance with the manufacturer's instructions and shall not be connected to any drainage system vent.

**1308.0 Aspirators.**

**1308.1** See Section 603.4.10, Water Inlets to Water Supplied Aspirators. Provisions for aspirators or other water supplied suction devices shall be installed only with the specific approval of the Authority Having Jurisdiction. Where aspirators are used for removing body fluids, they shall include a collection container to collect liquids and solid particles. Aspirators shall indirectly discharge to the sanitary drainage system through an air gap in accordance with Chapter 8. The potable water supply to an aspirator shall be protected by a vacuum breaker or equivalent backflow protection device in accordance with Section 603.0.

**Part II—Medical Gas and Vacuum Systems.****1309.0 Application.**

**1309.1** The provisions herein shall apply to the installation, testing, and verification of medical gas and vacuum piping in hospitals, clinics, and other health care facilities.

**1309.2** The purpose of this chapter is to provide requirements for the installation, testing, and verification of medical gas and medical vacuum systems, from the central supply system to the station outlets or inlets.

**1309.3** Wherever the terms *medical gas* or *vacuum* occur, the provisions shall apply to all piped systems for oxygen, nitrous oxide, medical air, carbon dioxide, helium, nitrogen, medical-surgical vacuum, waste anesthetic gas disposal, and mixtures thereof. Wherever the name of a specific gas or vacuum service occurs, the provision shall apply only to that gas. [NFPA 99 5.1.1.2]

**1309.4** This chapter does not apply to portable compressed gas systems. [NFPA 99 4-1.3]

**1309.5** This chapter does not apply to:

- (A) Cylinder and container management, storage, and reserve requirements
- (B) Gas central supply and bulk supply systems except as addressed in this chapter
- (C) Electrical connections and requirements

- (D) Motor requirements and controls
- (E) Systems having non-standard operating pressures except as addressed in this chapter
- (F) Waste anesthetic gas disposal (WAGD) systems
- (G) Surface-mounted medical gas rail systems

**1309.6** The requirements of this chapter shall not be interpreted to conflict with the requirements of NFPA 99 *Standard for Health Care Facilities*. For requirements of portions of medical gas and medical vacuum systems not addressed in this chapter or medical gas and medical vacuum systems beyond the scope of this chapter refer to NFPA 99 *Standard for Health Care Facilities*.

**1309.7** An existing system that is not in strict compliance with the provisions of the standard (Code) shall be permitted to be continued in use as long as the Authority Having Jurisdiction has determined that such use does not constitute a distinct hazard to life. [NFPA 99 4-1.4] (Same as the 2002 edition of NFPA 99 5.1.1.3)

**1310.0 Definitions.**

**1310.1 Building Supply** – The pipe from the source of supply to a building or structure.

**1310.2 Critical Care Area** – Those special care units, intensive care units, coronary care units, angiography laboratories, cardiac catheterization laboratories, delivery rooms, operating rooms, postanesthesia recovery rooms, emergency departments, and similar areas in which patients are intended to be subjected to invasive procedures and connected to line-operated, patient-care-related electrical appliances. [NFPA 99 3.3.135.2]

**1310.3 General Care Areas** – General care areas are patient bedrooms, examining rooms, treatment rooms, clinics, and similar areas in which it is intended that the patient will come in contact with ordinary appliances such as a nurses-call system, electric beds, examining lamps, telephones, and entertainment devices. [NFPA 99 2-2]

**1310.4 Manifold** – A device for connecting outlets of one or more gas cylinders to the central piping system for that specific gas. [NFPA 99 2-2]

**1310.5 Medical Air** – For purposes of this standard, medical air is air supplied from cylinders, bulk containers, medical air compressors, or has been reconstituted from oxygen USP and oil-free, dry nitrogen NF. Medical air shall be required to have the following characteristics:

- (1) Be supplied from cylinders, bulk containers, medical air compressor sources, or be reconstituted from oxygen USP and oil-free dry nitrogen NF

- (2) Meet the requirements of medical air USP
- (3) Have no detectable liquid hydrocarbons
- (4) Have less than 25 ppm gaseous hydrocarbons
- (5) Have equal to or less than 5 mg/m<sup>3</sup> of permanent particulates sized 1 micron or larger in the air at normal atmospheric pressure [NFPA 99 3.3.106, 5.1.3.5.1]

**1310.6 Medical Gas** – Gas used in a medical facility, including oxygen, nitrous oxide, nitrogen, carbon dioxide, helium, medical air, and mixtures of these gases. Standards of purity apply.

**1310.7 Medical Gas System** – Complete system consisting of a central supply system (manifold, bulk, or compressors), including control equipment and piping extending to station outlets at the points where medical gases may be required.

**1310.8 Medical Vacuum System** – See 1310.19, Vacuum System – Level 1

**1310.9 Nitrogen, Oil-Free, Dry (Nitrogen for Brazing and Testing)** - Nitrogen complying, at a minimum, with nitrogen NF. [NFPA 99 2-2]

**1310.10 Patient Care Area** – Any portion of a health care facility wherein patients are intended to be examined or treated. [NFPA 99 2-2]

**1310.11 Purge, Flow** – The removal of oxygen from a system by oil-free dry nitrogen during brazing.

**1310.12 Purge, System** – The removal of nitrogen from a system with the medical gas required for that system.

**1310.13 SCFM** – Standard cubic feet per minute. [NFPA 99 3.3.159]

**1310.14 Special Hazard Area** – An area such as a kitchen or electrical switch-gear room.

**1310.15 Station Inlet** – An inlet point in a Type I medical-surgical piped vacuum distribution system at which the user makes connections and disconnections. [NFPA 99 2-2]

**1310.16 Station Outlet** – An inlet point in a piped medical/surgical vacuum distribution system at which the user makes connections and disconnections. [NFPA 3.3.167]

**1310.17 Use Point** – A room or area of a room, where medical gases are dispensed to a single patient for medical purposes. A use point is permitted to be comprised of a number of station outlets of different gases. [NFPA 99 2-2]

**1310.18 User Outlet** – See **Station Outlet**.

**1310.19 Vacuum System – Level 1** – A system consisting of central vacuum-producing equipment with pressure and operating controls, shutoff valves, alarm warning systems, gauges, and a network of piping extending to and terminating with suitable

station inlets at locations where patient suction could be required. [NFPA 99 2-2]

**1310.20 Valve, Isolation** – A valve which isolates one piece of equipment from another.

**1310.21 Valve, Riser** – A valve at the base of a vertical riser, which isolates that riser.

**1310.22 Valve, Service** – A valve serving horizontal piping extending from a riser to a station outlet or inlet.

**1310.23 Valve, Source** – A single valve at the source which controls a number of units that make up the source.

**1310.24 Valve, Zone** – A valve which controls the gas or vacuum to a particular area.

**1310.25 Waste Anesthetic Gas Disposal** – The process of capturing and carrying away gases vented from the patient breathing circuit during the normal operation of gas anesthesia or analgesia equipment. [NFPA 99 3.3.178]

### 1311.0 General Requirements.

**1311.1 Oxygen Compatibility** - Tubes, valves, fittings, station outlets, and other piping components in medical gas systems shall have been cleaned for oxygen service by the manufacturer prior to installation in accordance with CGA 4.1, *Cleaning Equipment for Oxygen Service*, except that fittings shall be permitted to be cleaned by a supplier or agency other than the manufacturer. [NFPA 99 5.1.10.1.1]

**1311.1.1** Components include but are not limited to containers, valves, valve seats, lubricants, fittings, gaskets, and interconnecting equipment including hose. Easily ignitable materials should be avoided.

Compatibility involves both combustibility and ease of ignition. Materials that burn in air will burn violently in pure oxygen at normal pressure and explosively in pressurized oxygen. Also, many materials that do not burn in air will do so in pure oxygen, particularly under pressure. Metals for containers and piping have to be carefully selected, depending on service conditions. The various steels are acceptable for many applications, but some service conditions can call for other materials (usually copper or its alloys) because of their greater resistance to ignition and lower rate of combustion. Similarly, materials that can be ignited in air have lower ignition energies in oxygen. Many such materials can be ignited by friction at a valve seat or stem packing or by adiabatic compression produced when oxygen at high

pressure is rapidly introduced into a system initially at low pressure.

**1311.1.2** Materials used in central supply systems shall meet the following requirement:

In those portions of systems intended to handle oxygen or nitrous oxide at gauge pressures of less than 2070 kPa (300 psi), material construction shall be compatible with oxygen under the temperatures and pressures to which the components can be exposed in the containment and use of oxygen, nitrous oxide, mixtures of these gases, or mixtures containing more than 23.5 percent oxygen. [NFPA 99 5.1.3.4.3 (2)]

**1311.2** Certification of medical gas and medical vacuum systems shall conform to the requirements of Section 1331.0 of this code, the Authority Having Jurisdiction, and NFPA 99 *Standard for Health Care Facilities* section 5.1.12. [NFPA 5.1.12].

**1311.3** Prior to any installation work, the installer of medical gas and vacuum piping shall provide and maintain documentation on the job site for the qualification of brazing procedures and individual brazers that is required under 1311.6. [NFPA 99 5.1.10.6.11.4]

**1311.3.1** Each length of tube shall be delivered plugged or capped by the manufacturer and kept sealed until prepared for installation. Fittings, valves, and other components shall be delivered sealed, labeled, and kept sealed until prepared for installation. [NFPA 99 5.1.10.1.2 and 5.1.10.1.3]

**1311.4** All medical gas and medical vacuum systems shall be supplied from a source consisting of at least two units – primary and secondary, e.g., a manifold consisting of two cylinder banks with at least two cylinders in each bank, minimum of two air compressors, or minimum of two vacuum pumps. However, two supply pipelines are not required.

**1311.5** Health Care Organization personnel shall be permitted to install piping systems if all the requirements of this chapter are met during installation. [NFPA 99 4-3.1.2.10(b)]

**1311.6** Brazing procedures and brazer performance for the installation of medical gas and vacuum piping shall be qualified in accordance with either *Section IX, Welding and Brazing Qualifications*, of the ASME Boiler and Pressure Vessel Code, or AWS B2.2, *Standard for Brazing Procedure and Performance Qualifications*, both as modified below. [NFPA 5.1.10.6.12.1]

**1311.6.1** Brazers shall be qualified by visual examination of the test coupon followed by sectioning. [NFPA 5.1.10.6.12.2]

**1311.6.2** The Brazing Procedure Specification (BPS) shall address cleaning, joint clearance, overlap, internal purge gas purge gas flow rate, and filler metal. [NFPA 99 4-3.1.2.12(b)]

**1311.6.3** The brazing procedure specification and the record of brazer performance qualification shall document filler metal used, cleaning, joint clearance, overlap, internal purge gas and flow rate during brazing of coupon, and the absence of internal oxidation in the completed coupon. [NFPA 5.1.10.6.12.4]

**1311.6.4** Brazing procedures qualified by a technically competent group or agency shall be permitted under the following conditions:

- (1) The brazing procedure specification and the procedure qualification record meets the requirements of this standard.
- (2) The employer obtains a copy of both the brazing procedure specification and the supporting qualification records from the group or agency and signs and dates these records, thereby accepting responsibility for the qualifications that were performed by the group or agency.
- (3) The employer qualifies at least one brazer following each brazing procedure specification used. [NFPA 5.1.10.6.12.5]

**1311.6.5** An employer shall be permitted to accept brazer qualification records of a previous employer under the following conditions:

- (1) The brazer has been qualified following the same or an equivalent procedure that the new employer uses.
- (2) The new employer obtains a copy of the record of brazer performance qualification tests from the previous employer and signs and dates these records, thereby accepting responsibility for the qualifications performed by the previous employer. [NFPA 99 5.1.10.6.12.6]

**1311.6.6** Performance qualifications of brazers shall remain in effect indefinitely unless the brazer does not braze with the qualified procedure for a period exceeding 6 months, or there is a specific reason to question the ability of the brazer." [NFPA 99 5.1.10.6.12.7]

## **1312.0 Plan Review.**

**1312.1** Before any medical gas or medical vacuum system is installed or altered in any hospital, medical facility, or clinic, duplicate plans and specifications shall be filed with the Authority Having Jurisdiction, Approval of the plans shall be obtained prior to

issuance of any permit by the Authority Having Jurisdiction.

**1312.2** Plans and specifications shall show the following, in detail:

**1312.2.1** Plot plan of the site, drawn to scale, indicating the location of existing or new cylinder storage areas, property lines, driveways, and existing or proposed buildings.

**1312.2.2** Piping layout of the proposed piping system or alteration, including alarms, valves, origin of gases, and user outlets/inlets. The demand and loading of any piping, existing or future, shall also be indicated.

**1312.2.3** Complete specification of materials.

**1312.3** Plans and specifications submitted to the Authority Having Jurisdiction shall clearly indicate the nature and extent of the work proposed and shall show in detail that such work will conform to the provisions of this code.

**1312.4** A record of as-built plans and valve identification records shall remain on the site at all times.

### **1313.0 System Performance.**

**1313.1 Required Operating Pressures.** All medical gas and medical vacuum systems shall be capable of delivering service in the pressure ranges listed in Table 13-1. [NFPA 99 Table 5.1.11]

**1313.2 Minimum Flow Rates.** All medical gas and medical vacuum systems shall be capable of supplying the flow rates listed in Table 13-2.

**1313.3 Minimum Station Outlets/Inlets.** Station outlets and inlets for medical gas and medical vacuum systems shall be provided as listed in Table 13-3.

### **1314.0 (Reserved)**

### **1315.0 Required Pipe Sizing.**

**1315.1** Where the maximum demand for each medical gas or vacuum system and the maximum length of piping between the source equipment and the most distant station outlet/inlet do not exceed the values in Table 13-6, the size of pipe of each section of the system shall be determined using Tables 13-4 and 13-6. The size for systems beyond the range of Table 13-6 shall be determined by using the methods set forth in Section 1315.3 of this chapter.

**1315.2** To determine the size of each section of pipe in any system within the range of Table 13-6, proceed as follows:

**1315.2.1** Measure the length of the pipe from the source equipment location to the most remote station inlet/outlet on the system.

**1315.2.2** In Table 13-6, select the column showing that distance, or the next longer distance if the table does not give the exact length.

**1315.2.3** Starting at the most remote outlet/inlet, find in the vertical column just selected, the medical gas or vacuum demand for that inlet/outlet. If the exact figure of demand is not shown, choose the next larger figure below in the column.

**1315.2.4** Opposite this demand figure, in the first column at the left in Table 13-6 will be found the correct size of pipe.

**1315.2.5** Using this same vertical column, proceed in a similar manner for each section of pipe serving this inlet/outlet. For each section of pipe, determine the total gas or vacuum demand supplied by the section, using Table 13-4.

**1315.2.6** Size each section of branch piping not previously sized by measuring the distance from the source equipment location to the most remote inlet/outlet in that branch, and follow the procedures of Sections 1315.2.2, 1315.2.3, 1315.2.4, and 1315.2.5.

#### **Note:**

Size branch piping in the order of the distance from the source location, beginning with the most distant outlet not previously sized.

**1315.3** For conditions other than those covered by Section 1315.1 of this section, such as longer runs of greater gas or vacuum demands, the size of each gas or vacuum piping system shall be determined by standard engineering methods acceptable to the Authority Having Jurisdiction, and each system shall be so designed that the total pressure drop or gain between the source equipment and any inlet/outlet will not exceed the allowable pressures shown in Table 13-1.

### **1316.0 Workmanship.**

**1316.1** All design, construction, and workmanship shall be in conformity with accepted engineering practices and shall meet the requirements of this code.

**1316.2** Cracks, holes, or other imperfections in materials shall not be concealed by welding, brazing, or soldering, or by using paint, wax, tar, or other leak-sealing or repair agents.

**1316.3** Burred ends of all tubing shall be deburred using a deburring tool to the full bore of the tube, and all chips shall be removed.

**1317.0 Materials.** The provisions of this section apply to the field-installed piping for the distribution of medical piped gases. [NFPA 4-3.1.2.7]

**1317.1** Tubes, valves, fittings, station outlets, and other piping components in medical gas systems shall have been cleaned for oxygen service by the manufacturer prior to installation in accordance with CGA 4.1, *Cleaning Equipment for Oxygen Service*, except that fittings shall be permitted to be cleaned by a supplier or agency other than the manufacturer. [NFPA 99: 5.1.10.1.1]

**1317.2** Each length of tube shall be delivered plugged or capped by the manufacturer and kept sealed until prepared for installation. Fittings, valves, and other components shall be delivered sealed, labeled, and kept sealed until prepared for installation. [NFPA 99: 5.1.10.1.2, 5.1.10.1.3]

**1317.3** Tubes shall be hard-drawn seamless copper ASTM B 819 medical gas tube, Type L, except that where operating pressures are above a gauge pressure of 1275 kPa (185 psi), Type K shall be used for sizes larger than DN80 (NPS 3) (3-1/8 in. O.D.).

ASTM B 819 medical gas tube shall be identified by the manufacturer's markings "OXY," "MED," "OXY/MED," "OXY/ACR," or "ACR/MED" in blue (Type L) or green (Type K).

Vacuum tubes shall be hard-drawn seamless copper, either ASTM B 819 medical gas tube, ASTM B 88 water tube (Type K, L, or M), or ASTM B 280 ACR tube.

Piping systems shall be designed and sized to deliver the required flow rates at the utilization pressures.

Mains and branches in medical gas-piping systems shall be not less than DN15 (NPS 1/2) (5/8 in. O.D.) size.

Mains and branches in medical-surgical vacuum systems shall be not less than DN20 (NPS 3/4) (7/8 in. O.D.) size.

Drops to individual station outlets and inlets shall be not less than DN15 (NPS 1/2) (5/8 in. O.D.) size.

Runouts to alarm panels and connecting tubing for gauges and alarm devices shall be permitted to be DN8 (NPS 1/4) (3/8 in. O.D.) size. [NFPA 99 5.1.10.1.4, 5.1.10.1.5, 5.1.10.2.1, 5.1.10.6]

**1317.3.1** For systems operated at pressures between 200 and 300 psig (1380 and 2070 kPa, respectively) ASTM B819, Type K copper shall be used. [NFPA 99 4-3.1.2.7(c)]

**1317.4** Turns, offsets, and other changes in direction in medical gas and vacuum piping shall be made with brazed wrought-copper capillary fittings

complying with ANSI B16.22, *Wrought Copper and Copper Alloy Solder-Joint Fittings*; or brazed fittings complying with MSS SP-73, *Brazed Joints for Wrought and Cast Copper Alloy Solder Joint Pressure Fittings*; or for vacuum only, fittings as permitted as follows:

- (A) Couplings and fittings rated by the coupling/fitting manufacturer for full vacuum service and having mechanically pressed joints that include a resilient O-ring seal that is rated for use with anesthetizing agents.
- (B) Grooved joints rated by the coupling/fitting manufacturer for full vacuum service consisting of roll-grooved tube ends and mechanical-joint couplings that include resilient gaskets rated for use with anesthetizing agents.
- (C) Copper tube shall not be joined by roll-grooving if less than DN50 (NPS 2 in.) pipe size.
- (D) Mechanically pressed joints and grooved joints shall be made using the coupling/fitting manufacturer's recommended procedure.

**1317.4.1** Cast-copper alloy fittings shall not be permitted.

**1317.4.2** Branch connections in vacuum piping systems shall be permitted to be made using mechanically formed, drilled, and extruded tee-branch connections that are formed in accordance with the tool manufacturer's instructions, and brazed. [NFPA 5.1.10.3.1, 5.1.10.3.2, 5.1.10.3.3, 5.1.10.5.8 (4)-(7)]

### 1317.5 RESERVED

**1317.6** The following special fittings shall be permitted to be used in lieu of brazed joints:

- (1) Memory-metal couplings having temperature and pressure ratings joints not less than that of a brazed joint.
- (2) Listed or approved metallic gas tube fittings that, when made up, provide a permanent joint having the mechanical, thermal, and sealing integrity of a brazed joint.
- (3) Dielectric fittings where required by the manufacturer of special medical equipment to electrically isolate the equipment from the piping distribution system.
- (4) Couplings and fittings rated by the coupling/fitting manufacturer for full vacuum service and having mechanically pressed joints that include a resilient O-ring

seal that is rated for use with anesthetizing agents.

- (5) Grooved joints rated by the coupling/fitting manufacturer for full vacuum service consisting of roll-grooved tube ends and mechanical-joint couplings that include resilient gaskets rated for use with anesthetizing agents.
- (6) Copper tube shall not be joined by roll-grooving if less than DN50 (NPS 2 in.) pipe size.
- (7) Mechanically pressed joints and grooved joints shall be made using the coupling/fitting manufacturer's recommended procedure.

**1317.7** The following joints shall be prohibited throughout medical gas and vacuum distribution pipeline systems:

- (1) Flared and compression-type connections, including connections to station outlets and inlets, alarm devices, and other components.
- (2) Other straight-threaded connections, including unions.

**1317.7.1** Threaded joints in medical gas and vacuum distribution piping shall meet the following requirements:

- (1) Be limited to connections to pressure/vacuum indicators, alarm devices, and source equipment.
- (2) Be tapered pipe threads complying with ANSI B1.20.1, *Pipe Threads, General Purpose*.
- (3) Be made up with polytetrafluoroethylene (such as Teflon™) tape or other thread sealant recommended for oxygen service, with the sealant applied to the male threads only. [NFPA 99 5.1.10.5.8, 5.1.10.5.9 and 5.1.10.4]

**1317.8** New or replacement shutoff valves shall be as follows:

- (1) Quarter turn, full ported ball type
- (2) Brass or bronze construction
- (3) Have extensions for brazing
- (4) Have a handle indicating open or closed
- (5) Consist of three pieces permitting inline serviceability [NFPA 99 5.1.4.3]

**1317.9** Tubes shall be hard-drawn seamless copper ASTM B 819 medical gas tube, Type L, except that where operating pressures are above a gauge pressure of 1275 kPa (185 psi) Type K shall be used for sizes larger than DN80 (NPS 3) (3-1/8 in. O.D.). [NFPA 5.1.10.1.4]

**1317.10** Vacuum tubes shall be hard-drawn seamless copper, either ASTM B 819 medical gas tube, ASTM B 88 water tube (Type K, L, or M), or ASTM B 280 ACR tube. Threaded joints in medical gas and vacuum distribution piping shall meet the following requirements:

- (1) Be limited to connections to pressure/vacuum indicators, alarm devices, and source equipment
- (2) Be tapered pipe threads complying with ANSI B1.20.1, *Pipe Threads, General Purpose*
- (3) Be made up with polytetrafluoroethylene (such as Teflon™) tape or other thread sealant recommended for oxygen service, with the sealant applied to the male threads only.

Soldered joints in copper Level 3 vacuum and Level 3 gas-powered systems piping shall be made in accordance with ASTM B 828, *Making Capillary Joints by Soldering of Copper and Copper Alloy Tube and Fittings*, using a lead-free solder filler metal containing not more than 0.2 percent lead by volume. [NFPA 5.1.10.2.1, 5.1.10.4, and 5.3.10.5]

**1317.10.1** Piping systems shall be designed and sized to deliver the required flow rates at the utilization pressures.

Mains and branches in medical gas piping systems shall be not less than DN15 (NPS 1/2) (5/8 in. O.D.) size.

Mains and branches in medical-surgical vacuum systems shall be not less than DN20 (NPS 3/4) (7/8 in. O.D.) size.

Drops to individual station outlets and inlets shall be not less than DN15 (NPS 1/2) (5/8 in. O.D.) size.

Runouts to alarm panels and connecting tubing for gauges and alarm devices shall be permitted to be DN8 (NPS 1/4) (3/8 in. O.D.) size. [NFPA 5.1.10.6 and its subsections.]

**1317.11** Turns, offsets, and other changes in direction in medical gas and vacuum piping shall be made with brazed wrought copper capillary fittings complying with ANSI B16.22, *Wrought Copper and Copper Alloy Solder-Joint Fittings*; or brazed fittings complying with MSS SP-73, *Brazed Joints for Wrought and Cast Copper Alloy Solder Joint Pressure Fittings*; or for vacuum only fittings, as permitted as shown below:

- (1) Couplings and fittings rated by the coupling/fitting manufacturer for full vacuum service and having mechanically pressed joints that include a resilient O-ring seal that is rated for use with anesthetizing agents.



- (2) Grooved joints rated by the coupling/fitting manufacturer for full vacuum service consisting of roll-grooved tube ends and mechanical-joint couplings that include resilient gaskets rated for use with anesthetizing agents.
- (3) Copper tube shall not be joined by roll-grooving if less than DN50 (NPS 2 in.) pipe size.
- (4) Mechanically pressed joints and grooved joints shall be made using the coupling/fitting manufacturer's recommended procedure. [NFPA 99 5.1.10.5.8 (4)-(7)] Cast-copper alloy fittings shall not be permitted.

Turns, offsets, and other changes in direction in medical gas piping, copper Level 3 vacuum piping, and piping for gas-powered devices shall be made with brazed wrought-copper capillary fittings complying with ANSI B16.22, *Wrought Copper and Copper Alloy Solder-Joint Fittings*, or brazing fittings complying with MSS SP-73, *Brazed Joints for Wrought and Cast Copper Alloy Solder Joint Pressure Fittings*.

Cast-copper alloy fittings shall not be used where joints are brazed.

Branch connections in copper vacuum piping systems shall be permitted to be made using mechanically formed, drilled, and extruded tee-branch connections that are formed in accordance with the tool manufacturer's instructions, and brazed. [NFPA 99 5.1.10.3.1, 5.3.10.3.1, and 5.3.10.3.3]

The following joints shall be prohibited throughout medical gas and vacuum distribution pipeline systems:

- (1) Flared and compression-type connections, including connections to station outlets and inlets, alarm devices, and other components
- (2) Other straight-threaded connections, including unions [NFPA 99 5.1.10.5.9]

New or replacement shutoff valves shall be as follows:

- (1) Quarter turn, full ported, ball type
- (2) Brass or bronze construction
- (3) Have extensions for brazing
- (4) Have a handle indicating open or closed
- (5) Consist of three pieces permitting inline serviceability [NFPA 99 5.1.4.3]

### 1318.0 Cleaning for Medical Gas Piping Systems.

**1318.1** Tubes, valves, fittings, station outlets, and other piping components in medical gas systems shall have been cleaned for oxygen service by the

manufacturer prior to installation in accordance with CGA 4.1, *Cleaning Equipment for Oxygen Service*, except that fittings shall be permitted to be cleaned by a supplier or agency other than the manufacturer. [NFPA 99 5.1.10.1.1]

**1318.2** The interior surfaces of tube ends, fittings, and other components that were cleaned for oxygen service by the manufacturer, but become contaminated prior to being installed, shall be permitted to be recleaned on-site by the installer by thoroughly scrubbing the interior surfaces with a clean, hot water-alkaline solution, such as sodium carbonate or trisodium phosphate 450 g to 11 L (1 lb to 3 gal) of potable water and thoroughly rinsing them with clean, hot potable water. Other aqueous cleaning solutions shall be permitted to be used for on-site recleaning permitted above, provided that they are as recommended in CGA Pamphlet G-4.1, *Cleaning Equipment for Oxygen Service*, and are listed in CGA Pamphlet O2-DIR, *Directory of Cleaning Agents for Oxygen Service*. [NFPA 99 5.1.10.5.3.10 and 5.1.10.5.3.11]

**1318.3** Material that has become contaminated internally and is not clean for oxygen service shall not be installed. [NFPA 99 5.1.10.5.3.12]

### 1319.0 Installation of Piping.

**1319.1** Piping shall be protected against freezing, corrosion, and physical damage.

Piping exposed in corridors and other areas where subject to physical damage from the movement of carts, stretchers, portable equipment, or vehicles shall be protected.

Piping underground within buildings or embedded in concrete floors or walls shall be installed in a continuous conduit. [NFPA 99 5.1.10.6.2]

**1319.2** Piping risers shall be permitted to be installed in pipe shafts if protected from physical damage, effects of excessive heat, corrosion, or contact with oil.

Piping shall not be installed in kitchens, electrical switchgear rooms, elevator shafts, and areas with open flames.

Medical gas piping shall be permitted to be installed in the same service trench or tunnel with fuel gas lines, fuel oil lines, electrical lines, steam lines, and similar utilities provided that the space is ventilated (naturally or mechanically) and the ambient temperature around the medical gas piping is limited to 54°C (130°F) maximum.

Medical gas piping shall not be located where subject to contact with oil, including a possible

flooding area in the case of a major oil leak. [NFPA 99 5.1.10.6.3]

**1319.3** Buried piping outside of buildings shall be installed below the local level of frost penetration.

**1319.4** Underground piping shall be installed in a continuous enclosure to protect the pipe during backfilling.

The continuous enclosure shall be split or otherwise provide access at the joints during visual inspection and leak testing.

Buried piping that will be subject to surface loads shall be buried at a depth that will protect the piping and its enclosure from excessive stresses.

The minimum backfilled cover above the top of the enclosure for buried piping outside of buildings shall be 900 mm (36 in.), except that the minimum cover shall be permitted to be reduced to 450 mm (18 in.) where physical damage is otherwise prevented.

Trenches shall be excavated so that the pipe enclosure has firm, substantially continuous bearing on the bottom of the trench.

Backfill shall be clean and compacted so as to protect and uniformly support the pipe enclosure.

A continuous tape or marker placed immediately above the enclosure shall clearly identify the pipeline by specific name.

A continuous warning means shall also be provided above the pipeline at approximately one-half the depth of bury.

Where underground piping is installed through a wall sleeve, the ends of the sleeve shall be sealed to prevent the entrance of groundwater into the building. [NFPA 99 5.1.10.6.5]

**1319.5 RESERVED**

**1319.6 RESERVED**

**1319.7 RESERVED**

**1319.8** Hose and flexible connectors, both metallic and non-metallic, shall be no longer than necessary and shall not penetrate or be concealed in walls, floors, ceilings, or partitions. Flexible connectors, metallic or non-metallic, shall have a minimum burst pressure, with a gauge pressure of 6895 kPa (1000 psi). [NFPA 99 5.1.10.6.7]

**1319.9** Where a positive pressure medical gas-piping distribution system originally used or constructed for the use at one pressure and for one gas is converted for operation at another pressure or for another gas, all provisions of NFPA 5.1.10 shall apply as if the system were new.

A vacuum system shall not be permitted to be converted for use as a gas system. [NFPA 99 5.1.10.6.10]

**1319.10** Piping exposed in corridors and other areas where subject to physical damage from the movement of carts, stretchers, portable equipment, or vehicles shall be protected.

**1319.11** Piping shall be supported from the building structure in accordance with MSS Standard Practice SP-69, *Piping Hangers and Supports - Selection and Application*.

Hangers and supports shall comply with MSS Standard Practice SP-58, *Pipe Hangers and Supports - Materials, Design, and Manufacture*.

Hangers for copper tube shall have a copper finish and be sized for copper tube.

In potentially damp locations, copper tube hangers or supports that are in contact with the tube shall be plastic-coated or otherwise be insulated from the tube.

Maximum support spacing shall be in accordance with Table 13-7 [NFPA Table 5.1.10.6.4.5]

**1319.12** Where required, medical gas and vacuum piping shall be seismically restrained against earthquakes in accordance with the applicable building code. [NFPA 99 5.1.10.6.4.6] Seismic considerations shall conform to the requirements of this code and the Authority Having Jurisdiction.

**1319.13** Two or more medical gas-piping systems shall not be interconnected for testing or any other reason. Leak testing shall be accomplished by separately charging and testing the individual piping system. [NFPA 99 4-3.1.2.10(d)]

**1319.14** Piping shall be labeled by stenciling or adhesive markers that identify the medical gas or vacuum system. [NFPA 5.1.11.1.1]

Pipe labels shall show the name of the gas/vacuum system or the chemical symbol. [NFPA 99 5.1.11.1.2]

**1320.0 Joints.** This section sets forth the requirements for pipe joint installation for positive pressure medical gas systems.

**1320.1** Threaded joints in medical gas and vacuum distribution piping shall meet the following requirements:

- (1) Be limited to connections to pressure/vacuum indicators, alarm devices, and source equipment
- (2) Be tapered pipe threads complying with ANSI B1.20.1, *Pipe Threads, General Purpose*
- (3) Be made up with polytetrafluoroethylene (such as Teflon™) tape or other thread sealant recommended for oxygen service, with the sealant applied to the male threads only

Brazed joints shall be made using a brazing alloy that exhibits a melting temperature in excess of 538°C (1000°F) to retain the integrity of the piping system in the event of fire exposure. [NFPA 99 5.1.10.5.1.1]

Brazed tube joints shall be the socket type. [NFPA 99 5.1.10.5.1.2]

Filler metals shall bond with and be metallurgically compatible with the base metals being joined. [NFPA 99 5.1.10.5.1.3]

Filler metals shall comply with ANSI/AWS A.5.8, *Specification for Brazing Filler Metal*. [NFPA 99 5.1.10.5.1.4]

Copper-to-copper joints shall be brazed using a copper-phosphorus or copper-phosphorus-silver brazing filler metal (BCuP series) without flux. [NFPA 99 5.1.10.5.1.5]

Flux shall only be used when brazing dissimilar metals, such as copper and bronze or brass, using a silver (BAg series) brazing filler material. [NFPA 99 5.1.10.5.4.1]

Joints to be brazed in place shall be accessible for necessary preparation, assembly, heating, filler application, cooling, cleaning, and inspection. [NFPA 99 5.1.10.5.1.6]

**1320.2** Tube ends shall be cut square using a sharp tubing cutter to avoid deforming the tube. [NFPA 99 5.1.10.5.2.1]

The cutting wheels on tubing cutters shall be free from grease, oil, or other lubricant not suitable for oxygen service. [NFPA 99 5.1.10.5.2.2]

The cut ends of the tube shall be deburred with a sharp, clean deburring tool, taking care to prevent chips from entering the tube. [NFPA 99 5.1.10.5.2.3]

**1320.3** The interior surfaces of tubes, fittings, and other components that are cleaned for oxygen service shall be stored and handled to avoid contamination prior to assembly and brazing. [NFPA 99 5.1.10.5.3.1]

The exterior surfaces of tube ends shall be cleaned prior to brazing to remove any surface oxides. [NFPA 99 5.1.10.5.3.2]

When cleaning the exterior surfaces of tube ends, no matter shall be permitted to enter the tube. [NFPA 99 5.1.10.5.3.3]

If the interior surfaces of fitting sockets become contaminated prior to brazing, they shall be recleaned for oxygen in accordance with NFPA 99 5.1.10.5.3.10 and be cleaned for brazing with a clean, oil-free wire brush. [NFPA 99 5.1.10.5.3.4]

Non-abrasive pads shall be used to clean the exterior surfaces of tube ends. [NFPA 99 5.1.10.5.3.5]

The use of steel wool or sand cloth shall be prohibited. [NFPA 99 5.1.10.5.3.6]

The cleaning process shall not result in grooving of the surfaces to be joined. [NFPA 99 5.1.10.5.3.7]

After being abraded, the surfaces shall be wiped using a clean, lint-free white cloth. [NFPA 99 5.1.10.5.3.8]

Tubes, fittings, valves, and other components shall be visually examined internally before being joined to verify that they have not become contaminated for oxygen service and that they are free of obstructions or debris. [NFPA 99 5.1.10.5.3.9]

The interior surfaces of tube ends, fittings, and other components that were cleaned for oxygen service by the manufacturer, but become contaminated prior to being installed, shall be permitted to be recleaned on-site by the installer by thoroughly scrubbing the interior surfaces with a clean, hot water-alkaline solution, such as sodium carbonate or trisodium phosphate 450 g to 11 L (1 lb to 3 gal) of potable water and thoroughly rinsing them with clean, hot potable water. [NFPA 99 5.1.10.5.3.10]

Other aqueous cleaning solutions shall be permitted to be used for on-site recleaning permitted in 5.1.10.5.3.10 provided that they are as recommended in CGA Pamphlet G-4.1, *Cleaning Equipment for Oxygen Service*, and are listed in CGA Pamphlet O2-DIR, *Directory of Cleaning Agents for Oxygen Service*. [NFPA 99 5.1.10.5.3.11]

Material that has become contaminated internally and is not clean for oxygen service shall not be installed. [NFPA 99 5.1.10.5.3.12]

Joints shall be brazed within one hour after the surfaces are cleaned for brazing. [NFPA 99 5.1.10.5.3.13]

**1320.4** Flux shall only be used when brazing dissimilar metals such as copper and bronze or brass, using a silver (BAg series) brazing filler metal. [NFPA 99 5.1.10.5.4.1]

Surfaces shall be cleaned for brazing in accordance with 1320.3. [NFPA 99 5.1.10.5.4.2]

Flux shall be applied sparingly to minimize contamination of the inside of the tube with flux. [NFPA 99 5.1.10.5.4.3]

The flux shall be applied and worked over the cleaned surfaces to be brazed using a stiff bristle brush to ensure complete coverage and wetting of the surfaces with flux. [NFPA 99 5.1.10.5.4.4]

Where possible, short sections of copper tube shall be brazed onto the non-copper component and the interior of the subassembly shall be cleaned of flux prior to installation in the piping system. [NFPA 99 5.1.10.5.4.5]

On joints DN20 (NPS 3/4) (7/8 in. O.D.) size

and smaller, flux-coated brazing rods shall be permitted to be used in lieu of applying flux to the surfaces being joined. [NFPA 99 5.1.10.5.4.6]

**1320.5** Tube ends shall be inserted fully into the socket of the fitting. [NFPA 99 5.1.10.5.6.1]

Where flux is permitted, the joint shall be heated slowly until the flux has liquefied. [NFPA 99 5.1.10.5.6.2]

After flux is liquefied, or where flux is not permitted to be used, the joint shall be heated quickly to the brazing temperature, taking care not to overheat the joint. [NFPA 99 5.1.10.5.6.3]

Techniques for heating the joint; applying the brazing filler metal, and making horizontal, vertical, and large-diameter joints shall be as stated in sections on Applying Heat and Brazing and Horizontal and Vertical Joints in Chapter VII, Brazed Joints, in the CDA *Copper Tube Handbook*. [NFPA 99 5.1.10.5.6.4]

**1320.6** While being brazed, joints shall be continuously purged with oil-free, dry nitrogen NF to prevent the formation of copper oxide on the inside surfaces of the joint. [NFPA 99 5.1.10.5.5.1]

The source of the purge gas shall be monitored, and the installer shall be audibly alerted when the source content is low. [NFPA 99 5.1.10.5.5.2]

The purge gas flow rate shall not produce a positive pressure in the piping system. [NFPA 99 5.1.10.5.5.3]

The purge gas flow rate shall be controlled by the use of a pressure regulator and flow meter or combination thereof. [NFPA 99 5.1.10.5.5.4]

Pressure regulators alone shall not be used to control purge gas flow rates. [NFPA 99 5.1.10.5.5.5]

During and after installation, openings in the piping system shall be kept sealed to maintain a nitrogen atmosphere within the piping to prevent debris or other contaminants from entering the system. [NFPA 99 5.1.10.5.5.6]

While a joint is being brazed, a discharge opening shall be provided on the opposite side of the joint from where the purge gas is being introduced. [NFPA 99 5.1.10.5.5.7]

The flow of purge gas shall be maintained until the joint is cool to the touch. [NFPA 99 5.1.10.5.5.8]

After the joint has cooled, the purge discharge opening shall be sealed to prevent contamination of the inside of the tube and maintain the nitrogen atmosphere within the piping system. [NFPA 99 5.1.10.5.5.9]

The final connection of new piping to an existing, in-use pipeline shall be permitted to be

made without the use of a nitrogen purge. [NFPA 99 5.1.10.5.5.10]

After a final connection in a positive pressure medical gas pipeline is made without a nitrogen purge, an outlet in the immediate downstream zone of the affected portions of both the new and existing in-use piping shall be tested in accordance with NFPA 99: 5.1.12.3.9, Final Tie-In Test. [NFPA 99 5.1.10.5.5.11]

**1320.7** After brazing, the outside of all joints shall be cleaned by washing with water and a wire brush to remove any residue and permit clear visual inspection of the joint. [NFPA 99 5.1.10.5.7.1]

Where flux has been used, the wash water shall be hot. [NFPA 99 5.1.10.5.7.2]

Each brazed joint shall be visually inspected after cleaning the outside surfaces. [NFPA 99 5.1.10.5.7.3]

Joints exhibiting the following conditions shall not be permitted:

- (1) Flux or flux residue (when flux or flux coated BAG series rods are used with dissimilar metals)
- (2) Base metal melting or erosion
- (3) Unmelted filler metal
- (4) Failure of the filler metal to be clearly visible all the way around the joint at the interface between the socket and the tube
- (5) Cracks in the tube or component
- (6) Cracks in the braze filler metal
- (7) Failure of the joint to hold the test pressure under the installer-performed initial pressure test (1329.10) and standing pressure test (1329.11) [NFPA 99 5.1.10.5.7.4]

Brazed joints that are identified as defective under conditions 1320.7(2) or (5) shall be replaced. [NFPA 99 5.1.10.5.7.5]

Brazed joints that are identified as defective under conditions 1320.7(1), (3), (4), (6), or (7) shall be permitted to be repaired, except that no joint shall be reheated more than once before being replaced. [NFPA 99 5.1.10.5.7.6]

### **1321.0 Valves – Requirements, Locations, and Labeling.**

**1321.1 General Requirements.** Shutoff valves accessible to other than authorized personnel shall be installed in valve boxes with frangible or removable windows large enough to permit manual operation of valves. [NFPA 99 5.1.4.2.1]

Shutoff valves for use in certain areas, such as psychiatric or pediatric, shall be permitted to be

secured with the approval of the Authority Having Jurisdiction to prevent inappropriate access. [NFPA 99 5.1.4.2.2]

**1321.1.1** Where valves are concealed in any enclosure, the door or entry to the enclosure shall be identified and color coded with the type of gas service installed, as described in Section 1324.0. Enclosures shall be of sufficient size to permit valve operation. Valve handles in the off position shall prevent closure of the access panel or door.

**1321.2** In-line shutoff valves intended for use to isolate piping for maintenance or modification shall meet the following requirements:

- (1) Be located in a restricted area
- (2) Be locked or latched open
- (3) Be identified in accordance with Section 1324. [NFPA 99 5.1.4.9.1]

**1321.3** Shutoff valves provided for the connection of future piping shall meet the following requirements:

- (1) Be locked in a restricted area
- (2) Be locked or latched closed
- (3) Be identified in accordance with Section 1324 [NFPA 99 5.1.4.10]

**1321.3.1** Future connection valves shall be labeled as to gas content. [NFPA 99 5.1.4.10.1]

**1321.3.2** Downstream piping shall be closed with a brazed cap with tubing allowance for cutting and rebrazing. [NFPA 99 5.1.4.10.2]

**1321.3.3** A zone valve shall be located immediately outside each vital life-support, critical care, and anesthetizing location in each medical gas and/or vacuum line, and located so as to be readily accessible in an emergency. [NFPA 99 5.1.4.8.7]

**1321.3.4** All gas-delivery columns, hose reels, ceiling tracks, control panels, pendants, booms or other special installations shall be located downstream of the zone valve. [NFPA 99 5.1.4.8.7.1]

**1321.3.5** Zone valves shall be so arranged that shutting off the supply of gas to any one operating room or anesthetizing location will not affect the others. [NFPA 99 5.1.4.8.7.2]

**1321.4 Source Valve.** A shutoff valve shall be placed at the immediate connection of each source system to the distribution piping to permit the entire source, including all accessory devices (such as hair dryers, final line regulators, etc.), to be isolated from the facility. [NFPA 99 5.1.4.4]

**1321.4.1** The source valve shall be located in the immediate vicinity of the source equipment. [NFPA 99 5.1.4.4.1]

**1321.4.2** The source valve shall be labeled in accordance with Section 1324.0, Source Valve for the (Source Name). [NFPA 99 5.1.4.4.2, 5.1.11.2.3]

**1321.5 Main Valve.** A shutoff valve shall be provided in the main supply line inside of the building when the source shutoff valve is not accessible from within the building. [NFPA 99 5.1.4.5]

**1321.5.1** The main line valve shall be located to permit access by authorized personnel only (i.e., by locating above a ceiling or behind a locked access door). [NFPA 99 5.1.4.5.1]

**1321.5.2** The main line valve shall be located on the facility side of the source valve and outside of the source room, enclosure, or where the main line first enters the building. [NFPA 99 5.1.4.5.2]

**1321.5.3** The main line shall be labeled in accordance with Section 1324.0. [NFPA 99 5.1.4.5.3 and 5.1.11.2.4]

**1321.5.4** A main line valve shall not be required where the source shutoff valve is accessible from within the building. [NFPA 99 5.1.4.5.4]

**1321.6 Riser Valve.** Each riser supplied from the main line shall be provided with a shutoff valve adjacent to the riser connection. Riser valves shall be permitted to be located above ceilings, but shall remain accessible and not be obstructed. [NFPA 99 5.1.4.6, 5.1.4.6.1]

**1321.7 Zone Valve.** All station outlets/inlets shall be supplied through a zone valve as follows:

- (1) The zone valve shall be placed such that a wall intervenes between the valve and outlets/inlets that it controls.
- (2) The zone valve shall serve only outlets/inlets located on that same story.

**1321.7.1** Zone valves shall be readily operable from a standing position in the corridor on the same floor they serve. [NFPA 99 5.1.4.8.1]

**1321.7.2** Zone valves shall be so arranged that shutting off the supply of medical gas or vacuum to one zone will not affect the supply of medical gas or vacuum to another zone or the rest of the system. [NFPA 99 5.1.4.8.2]

**1321.8 Service Valves.** Service valves shall be placed in the branch piping prior to any zone valve box assembly on that branch. [NFPA 99 5.1.4.7.2]

**1321.8.1** Only one service valve shall be required for each branch off of a riser regardless of how many zone valve boxes are installed on that lateral. [NFPA 99 5.1.4.7.1]

**1321.8.2** Service valves shall be installed to

allow servicing or modification of lateral branch piping from a main or riser without shutting down the entire main, riser, or facility. [NFPA 99 5.1.4.7]

### 1322.0 Pressure-Regulating Equipment.

**1322.1** Pressure-regulating equipment shall be installed in the supply main upstream of the final line-pressure valve. Where multiple piping systems for the same gas at different operating pressures are required, separate pressure-regulating equipment, relief valves, and source shutoff valves shall be provided for each pressure.

**1322.2** Each central supply system shall have a pressure relief valve set at fifty (50) percent above normal line pressure, installed downstream of the pressure regulator and upstream of any shutoff valve. This pressure relief valve shall be permitted to be set at a higher pressure, provided another pressure relief valve set at 50 percent above normal line pressure is installed in the main supply line.

**1322.2.1** All pressure relief valves shall close automatically when excess pressure has been released.

**1322.2.2** Pressure relief valves set at 50 percent shall be vented to the outside from all gas systems, except medical air, or if the total capacity of the supply system is in excess of 3000 ft<sup>3</sup> (85 m<sup>3</sup>) of gas.

**1322.2.3** Pressure relief valves shall be of brass or bronze and specially designed for the gas service involved.

**1322.2.4** A pressure relief valve shall not be isolated from its intended use by any valve.

### 1322.3 Pressure Gauges.

Pressure and vacuum indicators shall be readable from a standing position. Pressure/vacuum indicators shall be provided at the following locations, as a minimum:

- (1) Adjacent to the alarm-initiating device for source main line pressure and vacuum alarms in the master alarm system
- (2) At or in area alarm panels to indicate the pressure/vacuum at the alarm activating device for each system that is monitored by the panel
- (3) On the station outlet/inlet side of zone valves [NFPA 99 5.1.8.2.1, 5.1.8.2.2]

### 1323.0 Station Outlets/Inlets.

Station outlets and inlets shall be installed in strict accordance with the manufacturer's instructions.

**1323.1** After installation of the piping, but before

installation of the station outlets/inlets and other medical gas and medical gas system components (e.g., pressure-actuating switches for alarms, manifolds, pressure gauges, or pressure relief valves), the line shall be blown clear by means of oil-free, dry nitrogen.

**1324.0 Labeling and Identification.** The gas content of medical gas piping systems shall be readily identifiable by appropriate labeling with the name and pressure contained. Such labeling shall be by means of metal tags, stenciling, stamping, or adhesive markers, in a manner that is not readily removable. Where supplementary color identification of piping if (sic) (probably means "is") used, it shall be in accordance with the gases and colors indicated in CGA Pamphlet C-9, *Standard Color-Marking of Compressed Cylinders Intended for Medical Gas Use*, See Table 13-1.

**1324.1** Piping shall be labeled by stenciling or adhesive markers that identify the medical gas or vacuum system. [NFPA 99 5.1.11.1.1]

Pipe labels shall show the name of the gas/vacuum system or the chemical symbol. [NFPA 99 5.1.11.1.2]

Pipe labels shall be located as follows:

- (1) At intervals of not more than 6100 mm (20 ft)
- (2) At least once in or above every room
- (3) On both sides of walls or partitions penetrated by the piping
- (4) At least once in every story height traversed by risers [NFPA 99 5.1.11.1.4]

**1324.2** Shutoff valves shall be identified as follows:

- (1) The name or chemical symbol for the specific medical gas or vacuum system
- (2) The room or areas served
- (3) A caution to not close or open valve except in emergency [NFPA 99 5.1.11.2.1]

**1324.3** Station outlets and inlets shall be identified as to the name or chemical symbol for the specific medical gas or vacuum provided. [NFPA 99 5.1.11.3.1]

**1324.4** The shutoff valves described in Sections 1321.4, 1321.5, and 1321.6 shall be labeled to reflect the rooms that are controlled by such valves. Labeling shall be kept current from initial construction through acceptance. Valves shall be labeled in substance as follows:

In-line shutoff valves shall be labeled in substance as follows:

**CAUTION**

**(NAME OF MEDICAL GAS) VALVE  
DO NOT CLOSE EXCEPT IN EMERGENCY  
THIS VALVE CONTROLS SUPPLY TO...**

Source valves shall be labeled in substance as follows:

**SOURCE VALVE  
FOR THE (SOURCE NAME).**

Main line valves shall be labeled in substance as follows:

**MAIN LINE VALVE FOR THE  
(GAS/VACUUM NAME) SERVING THE  
(NAME OF BUILDING).**

Riser valve(s) shall be labeled in substance as follows:

**RISER FOR THE (GAS/VACUUM NAME)  
SERVING (NAME OF THE AREA/BUILDING  
SERVED BY THE PARTICULAR RISER).**

Service valve(s) shall be labeled in substance as follows:

**SERVICE VALVE FOR THE  
(GAS/VACUUM NAME) SERVING  
(NAME OF THE AREA/BUILDING  
SERVED BY THE PARTICULAR VALVE).**

[NFPA 99 5.1.11.2.1]

**1325.0 Alarms.** All master, area, and local alarm systems used for medical gas and vacuum systems shall include the following:

- (1) Separate visual indicators for each condition monitored, except as permitted for local alarms that are displayed on master alarm panels
- (2) A cancelable audible indication of each alarm condition that produces a sound with a minimum level of 80 dBA at 920 mm (3 ft.)
- (3) A means to visually identify a lamp or LED failure
- (4) Visual and audible indication that the wiring to an alarm initiating device is disconnected
- (5) Labeling of each indicator, indicating the condition monitored
- (6) Labeling of each alarm panel for its area of surveillance [NFPA 99 5.1.9.1(1), (3), (4), (5), (6), (7)]

**1325.1** Functioning of all alarm components shall be verified in accordance with testing and monitoring

requirements of the manufacturer and the Authority Having Jurisdiction.

**1326.0 Medical Air System.** Medical air compressors shall be installed in a well-lit, ventilated, and clean location and shall be accessible. The location shall be provided with drainage facilities. The medical air compressor area shall be located separately from medical gas cylinder system sources, and shall be readily accessible for maintenance.

**1326.1** Medical air compressors shall be sufficient to serve the peak calculated demand with the largest single compressor out of service. In no case shall there be fewer than 2 (two) compressors. [NFPA 99 5.1.3.5.11.2]

Medical air compressor systems shall consist of the following:

- (1) An automatic means to prevent backflow from all on-cycle compressors through all off-cycle compressors
- (2) A manual shutoff valve to isolate each compressor from the centrally piped system and from other compressors for maintenance or repair without loss of pressure in the system
- (3) Intake filter-mufflers of the dry type
- (4) Pressure relief valves set at 50 percent above line pressure
- (5) Piping between the compressor and the source shutoff valve compatible with oxygen that does not contribute to contaminant levels and is cleaned for oxygen use  
[NFPA 99 5.1.3.5.3.2]

**1326.2** The medical air compressors shall draw their air from a source of clean air located where no contamination is anticipated from engine exhausts, fuel storage vents, medical-surgical vacuum system discharges, particulate matter, or odor of any type. [NFPA 99 5.1.3.5.13.1]

**1326.3** Compressor intake piping shall be of materials approved for vacuum piping under 1317.10 that will not add contaminants in the form of particulate matter, odor, or other gases. [NFPA 99 5.1.3.5.13.4, same words, new citation]

The compressor air intake shall be located outdoors above roof level, at a minimum distance of 3050 mm (10 ft) from any door, window, exhaust, other intake, or opening in the building and a minimum distance of 6100 mm (20 ft) above the ground. [NFPA 99 5.1.3.5.13.2]

If an air source equal to or better than outside air (e.g., air already filtered for use in operating room

ventilating systems) is available, it shall be permitted to be used for the medical air compressors with the following provisions:

- (1) This alternate source of supply air shall be available on a continuous 24-hour-per-day, 7-day-per-week basis.
- (2) Ventilating systems having fans with motors or drive belts located in the air stream shall not be used as a source of medical air intake. [NFPA 99 5.1.3.5.13.3]

Air intakes for separate compressors shall be permitted to be joined together to one common intake where the following conditions are met:

- (1) The common intake is sized to minimize back pressure in accordance with the manufacturer's recommendations
- (2) Each compressor can be isolated by manual or check valve, blind flange, or tube cap to prevent open inlet piping when compressors are removed from service and consequent backflow of room air into the other compressor (s) [NFPA 99 5.1.3.5.13.5]

**1326.3.1** Each medical air compressor shall have an isolation valve installed so that shutting off or failure of the largest unit will not affect the operation of the other unit(s).

**1326.4** Drains shall be installed on dryers, aftercoolers, separators, and receivers.

**1326.5** Medical air receivers shall be provided with a three-valve bypass to permit service to the receiver without shutting down the medical air system. [NFPA 99 5.1.3.5.11.4]

**1326.6 Medical Air Receivers.** Receivers for medical air shall meet the following requirements:

- (1) Be made of corrosion-resistant materials or otherwise be made corrosion resistant
- (2) Comply with Section VIII, Unfired Pressure Vessels, of the *ASME Boiler and Pressure Vessel Code*
- (3) Be equipped with a pressure relief valve, automatic drain, manual drain, sight glass, and pressure indicator
- (4) Be of a capacity sufficient to prevent the compressor from short cycling [NFPA 99 5.1.3.5.6]

Piping within compressor systems upstream of the source shutoff valve shall comply with Sections 1317 and 1320 except that stainless steel shall be permitted to be used as a piping material.

**1327.0 Medical Vacuum Pump System.** The vacuum plant shall be installed in a well lit, ventilated

and clean location with ample accessibility. The location shall be provided with drainage facilities. The vacuum plant, when installed as a source, shall be located separately from other medical vacuum system sources, and shall be readily accessible for maintenance.

**1327.1 Medical-surgical vacuum sources** shall consist of the following:

- (1) Two or more vacuum pumps sufficient to serve the peak calculated demand with the largest single vacuum pump out of service
- (2) An automatic means to prevent backflow from any on-cycle vacuum pumps through any off-cycle vacuum pumps
- (3) A shutoff valve or other isolation means to isolate each vacuum pump from the centrally piped system and other vacuum pumps for maintenance or repair without loss of vacuum in the system [NFPA 99 5.1.3.6.1.2(1), (2), (3)]

**1327.1.1** Additional pumps shall automatically activate when the pumps in operation are incapable of adequately maintaining the required vacuum.

Automatic or manual alternation of pumps shall allow division of operating time. If automatic alternation of pumps is not provided, the facility staff shall arrange a schedule for manual alternation. [NFPA 99 5.1.3.6.6.1, 5.1.3.6.6.2]

**1327.2 The medical-surgical vacuum pumps** shall exhaust in a manner and location that will minimize the hazards of noise and contamination to the facility and its environment.

The exhaust shall be located as follows:

- (1) Outdoors
- (2) At least 3050 mm (10 ft.) from any door, window, air intake, or other openings in buildings
- (3) At a level different from air intakes
- (4) Where prevailing winds, adjacent buildings, topography, or other influences that would not divert the exhaust into occupied areas or prevent dispersion of the exhaust

The end of the exhaust shall be turned down and screened or otherwise be protected against the entry of vermin, debris, or precipitation by screening fabricated or composed of a non-corroding material.

The exhaust shall be piped of materials approved for medical-surgical vacuum piping under Section 1317.3 (Vacuum tubes...).



The exhaust shall be free of dips and loops that might trap condensate or oil. Where such low points are unavoidable, a drip leg and valved drain shall be installed. [NFPA 99 5.1.3.6.7.1 - .5]

**1327.2.1** Vacuum exhausts from multiple pumps shall be permitted to be joined together to one common exhaust where the following conditions are met:

- (1) The common exhaust is sized to minimize back pressure in accordance with the pump manufacturer's recommendations.
- (2) Each pump can be isolated by manual or check valve, blind flange, or tube cap to prevent open exhaust piping when pumps are removed for service and consequent flow of exhaust air into the room. [NFPA 99 5.1.3.6.7.6]

### **1327.3 RESERVED**

**1327.4** Receivers for vacuum shall meet the following requirements:

- (1) Be made of ferrous and/or non-ferrous materials
- (2) Comply with Section VIII, Unfired Pressure Vessels, of the *ASME Boiler and Pressure Vessel Code*
- (3) Be capable of withstanding a gauge pressure of 415 kPa (60 psi) and 760 mm (29.9 in.) gauge HgV
- (4) Be equipped with a manual drain
- (5) Be of a capacity based on the technology of the pumps. [NFPA 99 5.1.3.6.3]

**1327.5** Piping between vacuum pumps, discharges, receivers, and the vacuum main line valve shall be in accordance with Section 1317.1 except that steel pipe shall be permitted to be either black or galvanized.

**1327.6** Drains shall be installed and terminate in an approved location.

### **1328.0 RESERVED**

#### **1329.0 Testing and Inspection.**

**1329.1** Scope inspection and testing shall be performed on all-new piped gas systems, additions, renovations, temporary installations, or repaired systems, to ensure the facility, by a documented procedure, that all applicable provisions of this document have been adhered to and system integrity

has been achieved or maintained. [NFPA 99 5.1.12.1.1.]

**1329.1.1** Tests and inspections required by this section shall not be interpreted to conflict with the requirements of NFPA 99 *Standard for Health Care Facilities*. Final certification or verification shall require the completion of all tests and inspections required by sections 4-3.4.1.1, 4-3.4.1.2, and 4-3.4.1.3 of NFPA 99 *Standard for Health Care Facilities*. For requirements of the portions of medical gas and medical vacuum systems testing and inspection not addressed in this chapter or medical gas and medical vacuum systems testing and inspection beyond the scope of this chapter refer to NFPA 99 *Standard for Health Care Facilities*.

**1329.2** All systems that are breached and components that are subject to additions, renovations, or replacement (e.g., new gas sources: bulk, manifolds, compressors, dryers, alarms) shall be inspected and appropriately tested. [NFPA 99 5.1.12.1.3]

**1329.2.1** Systems shall be deemed breached at the point of pipeline intrusion by physical separation or by system component removal, replacement, or addition.

Breached portions of the systems subject to inspection and testing shall be confined to only the specific altered zone and components in the immediate zone or area that is located upstream for vacuum systems and downstream for pressure gases at the point or area of intrusion. [NFPA 99 5.1.12.1.4, 5.1.12.1.5]

**1329.3 Advance Notice.** It shall be the duty of the person doing the work authorized by the permit to notify the Authority Having Jurisdiction, orally or in writing, that said work is ready for inspection. Such notification shall be given not less than twenty-four (24) hours before the work is to be inspected.

**1329.4 Responsibility.** The equipment, material, and labor necessary for inspection and testing shall be furnished by the permit holder or by the person who is requiring the inspection.

**1329.5 Testing.** Test shall be conducted in the presence of the Authority Having Jurisdiction or a duly appointed representative.

**1329.6 Retesting.** If the Authority Having Jurisdiction finds that the work does not pass tests, necessary corrections shall be made and the work shall then be resubmitted for test or inspection.

**1329.7 Initial Pressure Test – Piped Gas Systems.** Before attachment of system components (e.g., pressure-actuating switches for

alarms, manifolds, pressure gauges, or pressure relief valves), but after installation of the station outlets and inlets, with test caps in place, each section of the piping system shall be subjected to a test pressure of one and a half (1-1/2) times the working pressure [minimum one hundred-fifty (150) psig (1 Mpa gauge)] with oil-free dry nitrogen. This test pressure shall be maintained until each joint has been examined for leakage by means of soapy water or other equally effective means of leak detection safe for use with oxygen. The source shutoff valve shall be closed. Leaks, if any, shall be located, repaired, and retested in accordance with this paragraph. [NFPA 99 5.1.12.2.3.7]

**1329.8 Cross-Connection Test – Piped Gas Systems.** It shall be determined that no cross connections exist between the various medical gas and vacuum piping systems. [NFPA 99 5.1.12.2.4]

All piping systems shall be reduced to atmospheric pressure. [NFPA 99 5.1.12.2.4.1]

Sources of test gas shall be disconnected from all piping systems except for the one system being tested. [NFPA 99 5.1.12.2.4.2]

The system under test shall be charged with oil-free, dry nitrogen NF to a gauge pressure of 345 kPa (50 psi). [NFPA 99 5.1.12.2.4.3]

After the installation of the individual faceplates with appropriate adapters matching outlet/inlet labels, each individual outlet/inlet in each installed medical gas and vacuum piping system shall be checked to determine that the test gas is being dispensed only from the piping system being tested. [NFPA 99 5.1.12.2.4.4]

**1329.8.1** The source of test gas shall be disconnected and the system tested shall be reduced to atmospheric pressure. Each additional piping system shall then be tested in accordance with 1329.9. [NFPA 99 5.1.12.2.4.1, 5.1.12.2.4.5]

**1329.8.2** Where a medical vacuum system is installed, the cross-connection testing shall include that piped vacuum system with all medical gas-piping systems.

**1329.8.3** All medical-surgical vacuum systems shall be in operation so that these vacuum systems are tested at the same time the medical gas systems are tested. The proper labeling and identification of system outlets/inlets shall be confirmed during these tests. [NFPA 99 5.1.12.2.4.6]

**1329.9 Final Testing Standing Pressure Test – Piped Gas Systems.** After successful completion of the initial pressure tests under Section 1329.7, medical

gas distribution piping shall be subject to a standing pressure test. [NFPA 99 5.1.12.2.6]

Tests shall be conducted after the final installation of station outlet valve bodies, face plates, and other distribution system components (e.g., pressure alarm devices, pressure indicators, line pressure relief valves, manufactured assemblies, hose, etc.). [NFPA 99 5.1.12.2.6.1]

The source valve shall be closed during this test. [NFPA 99 5.1.12.2.6.2]

The piping systems shall be subjected to a 24-hour standing pressure test using oil-free, dry nitrogen NF. [NFPA 99 5.1.12.2.6.3]

Test pressures shall be 20 percent above the normal system operating line pressure. [NFPA 99 5.1.12.2.6.4]

**1329.9.1** After the piping system is filled with test gas, the supply valve and all outlets shall be closed and the source of test gas disconnected. The piping system shall remain leak-free for 24 hours. When making the standing pressure test, the only allowable pressure changes during the 24-hour test period shall be those caused by variations in the ambient temperature around the piping system. [NFPA 99 4-3.4.1.2(e)1]

At the conclusion of the tests, there shall be no change in the test pressure other than that attributed to changes of ambient temperature. [NFPA 99 5.1.12.2.6.5]

**1329.10 Initial Pressure Test – Piped Vacuum Systems.** Each section of the piping in medical gas and vacuum systems shall be pressure tested. [NFPA 99 5.1.12.2.3.1]

Initial pressure tests shall be conducted as follows:

- (1) After installation of station outlets/inlets rough-in assemblies. Test caps shall be permitted to be used.
- (2) Prior to the installation of components of the distribution piping system that would be damaged by the test pressure (e.g., pressure/vacuum alarm devices, pressure/vacuum indicators, line pressure relief valves, manufactured assemblies with flexible hose, etc.). [NFPA 99 5.1.12.2.3.2]

The source shutoff valve shall remain closed during these tests. [NFPA 99 5.1.12.2.3.3]

The test pressure for pressure gases shall be 1.5 times the system working pressure but not less than a gauge pressure of 1035 kPa (150 psi). [NFPA 99 5.1.12.2.3.4]

The test pressure for vacuum shall be not less than a gauge pressure of 415 kPa (60 psi). [NFPA 99 5.1.12.2.3.5]

The test pressure shall be maintained until each joint has been examined for leakage by means of soapy water or other equally effective means of leak detection that is safe for use with oxygen. [NFPA 99 5.1.12.2.3.6]

Leaks, if any, shall be located, repaired (if permitted), replaced (if required), and retested. [NFPA 99 5.1.12.2.3.7]

**1329.11 Standing Pressure Test – Piped Vacuum Systems.** After successful completion of the initial pressure tests under Section 1329.10, vacuum distribution piping shall be subjected to a standing vacuum test. [NFPA 99 5.1.12.2.7]

Tests shall be conducted after installation of all components of the vacuum system. [NFPA 99 5.1.12.2.7.1]

The piping systems shall be subjected to a 24-hour standing vacuum test. [NFPA 99 5.1.12.2.7.2]

Test pressure shall be not less than 300 mm (12 in.) gauge HgV. [NFPA 99 5.1.12.2.7.3]

During the test, the source of test vacuum shall be disconnected from the piping system. [NFPA 99 5.1.12.2.7.4]

At the conclusion of the test, there shall be no change in the vacuum other than that attributed to changes of ambient temperature, as permitted in the following: [NFPA 99 5.1.12.2.7.5]

Test vacuum changes due to expansion or contraction shall be permitted to be determined by means of the following pressure temperature relationship:

- (1) The calculated final absolute pressure equals the initial absolute pressure times the final absolute temperature, divided by the initial absolute temperature.
- (2) Absolute pressure is the gauge pressure reading plus 101.4 kPa (14.7 psi).
- (3) Absolute temperature is the temperature reading plus 238°C (460°F).
- (4) The final allowable gauge pressure reading equals the final allowable absolute pressure minus a gauge pressure of 101.4 kPa (14.7 psi). [NFPA 99 5.1.12.2.7.6]

Leaks, if any, shall be located, repaired (if permitted) or replaced (if required), and retested. [NFPA 99 5.1.12.2.7.7]

**1329.12 Corrections.** Notices of correction or violation shall be written by the Authority Having Jurisdiction and may be posted at the site of the work or mailed or delivered to the permittee or an authorized representative. Refusal or failure to comply with any such notice or order within ten (10) days of receipt thereof, shall be considered a

violation of this code, and shall be subject to the penalties set forth elsewhere in this code for violations.

**1329.13 Approval.** Upon satisfactory completion of all tests and certification of the medical gas and medical vacuum systems, a certificate of approval shall be issued by the Authority Having Jurisdiction to the permittee.

**1329.14 Covering or Use.** No medical gas or medical vacuum system or part thereof shall be covered, concealed, or put into use until it has been tested, inspected, and accepted as required in this code.

**1329.15 Uncovering.** Any medical gas and vacuum system or part thereof which is covered or concealed before testing and inspected as required in this code shall be uncovered for inspection, after notice to uncover the work has been issued to the permittee or his authorized representative by the Authority Having Jurisdiction.

### 1330.0 RESERVED

### 1331.0 System Certification.

**1331.1** Prior to any medical gas system being placed in service, each and every system shall be certified, as described in Section 1331.2.

**1331.1.1** Verification tests shall be performed only after all tests required in Section 1329.0, Installer-Performed Tests, have been completed. [NFPA 99 5.1.12.3.1.1]

Testing shall be conducted by a party technically competent and experienced in the field of medical gas and vacuum pipeline testing and meeting the requirements of ANSI/ASSE Standard 6030, *Medical Gas Verifiers Professional Qualifications Standard*. [NFPA 99 5.1.12.3.1.3]

Testing shall be performed by a party other than the installing contractor. [NFPA 99 5.1.12.3.1.4]

When systems have been installed by in-house personnel, testing shall be permitted by personnel of that organization who meet the requirements of this section. [NFPA 99 5.1.12.3.1.5]

**1331.2** Certification tests, verified and attested to by the certification agency, shall include the following:

**1331.2.1** Verifying compliance with the installation requirements;

**1331.2.2** Testing and checking for leakage, correct zoning, and identification of control valves;

**1331.2.3** Checking for identification and labeling of pipelines, station outlets, and control valves;

**1331.2.4** Testing for cross-connection, flow rate, system pressure drop, and system performance;

**1331.2.5** Functional testing of pressure relief valves and safety valves;

**1331.2.6** Functional testing of all sources of supply;

**1331.2.7** Functional testing of alarm systems, including accuracy of system components;

**1331.2.8** Purge flushing of system and filling with specific source gases;

**1331.2.9** Testing for purity and cleanliness of source gases;

**1331.2.10** Testing for specific gas identity at each station outlet.

**1331.3** The inspection and testing reports shall be submitted directly to the party that contracted for the testing, who shall submit the report through channels to the responsible facility authority and any others that are required. [NFPA 99 5.1.12.1.6]

Reports shall contain detailed listings of all findings and results. [NFPA 99 5.1.12.1.7]

**1331.4** A report which includes at least the specific items mentioned in Section 1331.2 and all other information required by NFPA 99 *Standard for Health Care Facilities* shall be delivered to the Authority Having Jurisdiction prior to acceptance of the system.

**TABLE 13-1**  
**Standard Designation Colors and Operating Pressures for Gas and Vacuum Systems**

<b>Gas Service</b>	<b>Abbreviated Name</b>	<b>Colors (Background/Text)</b>	<b>Standard Gauge Pressure</b>
Medical air	Med Air	Yellow/black	345–380 kPa (50–55 psi)
Carbon dioxide	CO <sub>2</sub>	Gray/black or gray/white	345–380 kPa (50–55 psi)
Helium	He	Brown/white	345–380 kPa (50–55 psi)
Nitrogen	N <sub>2</sub>	Black/white	1100–1275 kPa (160–185 psi)
Nitrous oxide	N <sub>2</sub> O	Blue/white	345–380 kPa (50–55 psi)
Oxygen	O <sub>2</sub>	Green/white or white/green	345–380 kPa (50–55 psi)
Oxygen/carbon dioxide mixture	O <sub>2</sub> /CO <sub>2</sub> n (n is % of CO <sub>2</sub> )	Green/white	345–380 kPa (50–55 psi)
Medical–surgical vacuum	Med Vac	White/black	360 mm to 760 mm (15 in. to 30 in. HgV)
Waste anesthetic gas disposal	WAGD	Violet/white	Varies with system type
Other mixtures	Gas A%/ Gas B%	Colors as above Major gas for background/ minor gas for text	None
Nonmedical air (level 3 gas-powered device)		Yellow and white diagonal stripe/black	None
Nonmedical and Level 3 vacuum		White and black diagonal stripe/black boxed	None
Laboratory air		Yellow and white checkerboard/black	None
Laboratory vacuum		White and black checkerboard/black boxed	None
Instrument air		Red/white	1100–1275 kPa (160–185 psi)

**TABLE 13-2**  
**Minimum Flow Rates**

Oxygen	.71 CFM per outlet <sup>1</sup> (20 LPM)
Nitrous Oxide	.71 CFM per outlet <sup>1</sup> (20 LPM)
Medical Compressed Air	.71 CFM per outlet <sup>1</sup> (20 LPM)
Nitrogen	15 CFM (0.42 m <sup>3</sup> /min.) free air per outlet
Vacuum	1 SCFM (0.03 sm <sup>3</sup> /min.) per inlet <sup>2</sup>
Carbon Dioxide	.71 CFM per outlet <sup>1</sup> (20 LPM)
Helium	.71 CFM per outlet (20 LPM)

<sup>1</sup> Any room designed for a permanently located respiratory ventilator or anesthesia machine shall have an outlet capable of a flow rate of 180 LPM (6.36 CFM) at the station outlet.

<sup>2</sup> For testing and certification purposes, individual station inlets shall be capable of a flow rate of 3 SCFM, while maintaining a system pressure of not less than 12 inches (305 mm) at the nearest adjacent vacuum inlet.

**TABLE 13-3**  
**Minimum Outlets/Inlets per Station**

Location	Oxygen	Medical Vacuum	Medical Air	Nitrous Oxide	Nitrogen	Helium	Carbon Dioxide
Patient rooms for medical/surgical, obstetrics, and pediatrics	1/bed	1/bed	1/bed	—	—	—	—
Examination/treatment for nursing units	1/bed	1/bed	—	—	—	—	—
Intensive care (all)	3/bed	3/bed	2/bed	—	—	—	—
Nursery <sup>1</sup>	2/bed	2/bed	1/bed	—	—	—	—
General operating rooms	2/room	3/room <sup>4</sup>	2/room	1/room	1/room	—	—
Cystoscopic and invasive special procedures	2/room	3/room <sup>4</sup>	2/room	—	—	—	—
Recovery delivery and labor/delivery/recovery rooms <sup>2</sup>	2/bed 2/room	2/bed 3/room <sup>4</sup>	1/bed 1/room	— —	— —	— —	— —
Labor rooms	1/bed	1/bed	1/bed	—	—	—	—
First aid and emergency treatment <sup>3</sup>	1/bed	1/bed <sup>4</sup>	1/bed	—	—	—	—
Autopsy	—	1/station	1/station	—	—	—	—
Anesthesia workroom	1/station	—	1/station	—	—	—	—

<sup>1</sup> Includes pediatric nursery.

<sup>2</sup> Includes obstetric recovery.

<sup>3</sup> Emergency trauma rooms used for surgical procedures shall be classified as general operating rooms.

<sup>4</sup> Vacuum inlets required are in addition to any inlets used as part of a scavenging system for removal of anesthetizing gases.

**TABLE 13-4**  
**System Sizing – Flow Requirements for Station Inlet/Outlet<sup>1</sup>**

Number of Inlet/Outlet Terminal Units per Facility	Diversity Percentage of Average Flow per Inlet/Outlet Terminal Units	Minimum Permissible System Flow <sup>2</sup> SCFM (liters/minute)	
		All Pressurized Medical Gas Systems	Vacuum Systems
1-10	100%	Actual Demand	See
11-25	75%	7.0 (200)	Table
26-50	50%	13.1 (375)	13-5
51-100	50%	17.5 (500)	

<sup>1</sup> Flow rates of station inlets/outlets per Table 13-2.

<sup>2</sup> The minimum system flow is the average inlet/outlet flow times the number of station inlets/outlets times the diversity percentage.

**TABLE 13-5**  
**Outlet Rating for Vacuum Piping Systems**

Location of Medical-Surgical Vacuum Outlets	Free-Air Allowance, Expressed as CFM (LPM) at 1 Atmosphere		Zone Allowances Corridors-Risers Main Supply Line-Valves	
	Per Room	Per Outlet	Simultaneous Usage, Factor Percent	Air to Be Transported CFM (LPM)*
Operating Rooms				
Major "A" (Radical, Open Heart) (Organ Transplant) (Radical Thoracic)	3.5 (99.1)	–	100	3.5 (99.1)
	3.5 (99.1)	–	100	3.5 (99.1)
	3.5 (99.1)	–	100	3.5 (99.1)
Major "B" (All Other Major ORs)	2.0 (56.6)	–	100	2.0 (56.6)
Minor	1.0 (28.3)	–	100	1.0 (28.3)
Delivery Rooms	1.0 (28.3)	–	100	1.0 (28.3)
Recovery Rooms (Post-Anesthesia) and Intensive Care Units (a minimum of 2 outlets per bed in each such department)				
1st outlet at each bed	–	3.0 (85.0)	50	1.5 (42.5)
2nd outlet at each bed	–	1.0 (28.3)	50	0.5 (14.2)
3rd outlet at each bed	–	1.0 (28.3)	10	0.1 (2.8)
All others at each bed	–	1.0 (28.3)	10	0.1 (2.8)
Emergency Rooms	–	1.0 (28.3)	100	1.0 (28.3)
Patient Rooms				
Surgical	–	1.0 (28.3)	50	0.5 (14.2)
Medical	–	1.0 (28.3)	10	0.1 (2.8)
Nurseries	–	1.0 (28.3)	10	0.1 (2.8)
Treatment and Examining Rooms	–	0.5 (14.2)	10	0.05 (1.4)
Autopsy Area	–	2.0 (56.6)	20	0.4 (11.3)
Inhalation Therapy, Central Supply and Instructional Areas	–	1.0 (28.3)	10	0.1 (2.8)

\*Free air at 1 atmosphere

**TABLE 13-6**  
**Size of Gas/Vacuum Piping**

		Maximum Delivery Capacity <sup>3</sup> in SCFM (LPM)									
Medical System	Gas Pipe Size Inch <sup>2</sup>	Length of Piping in Feet (m) <sup>1</sup>									
		100	(30)	250	(76)	500	(152)	750	(228)	1000	(304)
Oxygen	1/2	15.0	(425)	10.6	(300)	7.4	(209)	5.9	(167)	5.1	(144)
	3/4	40.0	(1133)	28.3	(801)	19.6	(555)	15.7	(445)	13.3	(377)
	1	50.0	(1416)	50.0	(1416)	40.2	(1138)	32.2	(912)	27.7	(784)
Nitrous Oxide	1/2	15.0	(425)	9.5	(269)	6.5	(184)	5.3	(150)	4.5	(127)
	3/4	30.0	(849)	24.7	(699)	17.1	(484)	13.7	(388)	11.7	(331)
	1	40.0	(1113)	40.0	(1133)	34.7	(983)	28.2	(798)	24.3	(688)
Medical Air	1/2	18.1	(512)	11.1	(314)	7.8	(221)	6.3	(177)	5.3	(151)
	3/4	40.0	(1133)	29.9	(847)	21.0	(595)	16.5	(467)	14.1	(399)
	1	50.0	(1416)	50.0	(1416)	42.1	(1192)	35.8	(1013)	29.2	(826)
Vacuum	1	22.8	(645)	13.7	(388)	9.5	(269)	7.6	(215)	6.5	(184)
	1-1/4	40.1	(1135)	24.5	(694)	16.7	(473)	13.3	(377)	11.2	(317)
	1-1/2	63.7	(1804)	38.9	(1101)	26.8	(759)	21.1	(600)	17.9	(507)
	2	132.7	(3758)	81.4	(2305)	56.0	(1586)	45.0	(1274)	38.3	(1084)
Nitrogen	1/2	25.0	(708)	25.0	(708)	25.0	(708)	23.8	(674)	20.6	(583)
	3/4	60.0	(1699)	60.0	(1699)	60.0	(1699)	60.0	(1699)	54.2	(1535)
	1	110.0	(3115)	110.0	(3115)	110.0	(3115)	110.0	(3115)	110.0	(3115)

<sup>1</sup> Length of piping includes a 30% allowance for fittings.

<sup>2</sup> One-half inch (12.7 mm) diameter pipe is the minimum size allowed in medical gas systems.

<sup>3</sup> Based on the following maximum pressure drops:

Oxygen, nitrous oxide, and medical air – 5 psig (10 in. Hg)

Vacuum – 1.96 psig (4 in. Hg)

Nitrogen – 20 psig (41 in. Hg)

**TABLE 13-7**  
**Maximum Pipe Support Spacing**

Pipe Size	Hanger Spacing		
	mm	ft.	
DN8 (NPS 1/4)	(3/8 in. O.D.)	1520	5
DN10 (NPS 3/8)	(1/2 in. O.D.)	1830	6
DN15 (NPS 1/2)	(5/8 in. O.D.)	1830	6
DN20 (NPS 3/4)	(7/8 in. O.D.)	2130	7
DN25 (NPS 1)	(1-1/8 in. O.D.)	2440	8
DN32 (NPS 1-1/4)	(1-3/8 in. O.D.)	2740	9
DN40 (NPS 1-1/2)	(1-5/8 in. O.D.)		
and larger		3050	10
Vertical risers, all sizes			
Every floor but not to exceed:		4570	15

[NFPA 99 5.1.10.6.4.1]





# CHAPTER 14

## MANDATORY REFERENCED STANDARDS

**TABLE 14-1**

### Standards for Materials, Equipment, Joints and Connections

**Where more than one standard has been listed for the same material or method, the relevant portions of all such standards shall apply.**

Standard Number	Standard Title	Application
AHAM DW-1-92	Household Electric Dishwashers	Appliances
AHAM DW-2PR-92	Plumbing Requirements for Household Dishwashers	Appliances
AHAM FWD-1-92	Food Waste Disposers	Appliances
AHAM HLW-2 PR-86	Plumbing Requirements for Home Laundry Equipment	Appliances
ANSI A13.1-81(R93)	Scheme for the Identification of Piping Systems	Piping
ANSI A21.10-98	Ductile-Iron and Gray-Iron Fittings, 3 in. through 48 in. (75 mm through 1200 mm), for Water and Other Liquids (same as AWWA C110)	Piping, Ferrous
ANSI A21.11-2000	Rubber-Gasket Joints for Ductile-Iron Pressure Pipe and Fittings (same as AWWA C111)	Piping, Ferrous
ANSI A21.51-96	Ductile-Iron Pipe, Centrifugally Cast, for Water (same as AWWA C151)	Piping, Ferrous
ANSI A21.53-2000	Ductile-Iron Compact Fittings, 3 in. through 24 in. (76 mm through 610 mm) and 54 in. through 64 in. (1400 mm through 1600 mm), for Water Service (same as AWWA C153)	Piping, Ferrous
ANSI A40.3-93	Stainless Steel	Piping, Ferrous
ANSI A106.6-70	Vitrified Clay Pipe (now CSA A60.1M-76[C1992])	Piping, Non-Metallic
ANSI A112.14.1-75 (R90)	Backwater Valves	Valves
ANSI A112.19.5-99	Trim for Water-Closet Bowls, Tanks, and Urinals	Fixtures
ANSI A112.21.2M-83	Roof Drains	DWV Components
ANSI A118.10-93	Load, Bearing, Bonded, Waterproof Membranes for Thin-Set Ceramic Tile and Dimension Stone Installations	Fixtures
ANSI B2.1-90	Pipe Threads (Except Dryseal) (replaced by ASME B1.20.1-98)	Joints
ANSI B16.40-85 (R94)	Manually Operated Thermoplastic Gas Shutoff and Valves in Gas Distribution Systems	Fuel Gas
ANSI/CSA LC 3-2000	Appliance Stands and Drain Pans	Miscellaneous
ANSI/ICC A117.1-98	Guidelines for Accessible and Usable Buildings and Facilities	Miscellaneous

Standard Number	Standard Title	Application
ANSI Z21.10.1-98	Gas Water Heaters – Volume I – Storage Water Heaters with Input Ratings of 75,000 Btu per Hour or Less (22 kW)	Appliances
ANSI Z21.10.3-2001	Gas Water Heaters – Volume III – Storage, with Input Ratings Above 75,000 Btu per Hour, Circulating and Instantaneous Water Heaters	Appliances
ANSI Z21.12-90	Draft Hoods	Appliances
ANSI Z21.13-2000	Gas-Fired Low-Pressure Steam and Hot-Water Boilers	Appliances
ANSI Z21.15-97	Manually Operated Gas Valves for Appliances, Appliance Connector, Valves, and Hose End Valves	Valves
ANSI Z21.22-99	Relief Valves and Automatic Gas Shutoff Devices for Hot-Water Supply Systems	Valves
ANSI Z21.24-2001	Connectors for Gas Appliances	Appliances
ANSI Z21.41-98 CSA 6.9-M98	Quick-Disconnect Devices for Use with Gas Fuel Appliances	Joints
ANSI Z21.56-98 CSA 4.7-2001	Gas-Fired Pool Heaters	Swimming Pools and Spas
ANSI Z21.69-97 CSA 6.16-M97	Connectors for Movable Gas Appliances	Appliances
ANSI Z21.70-81[D]	Earthquake-Actuated Automatic Gas Shutoff Systems (withdrawn from ANSI June 1992) (replaced by ASCE 25)	Valves
ANSI Z21.80-1997 CSA 6.22-M97	Line Pressure Regulators	Fuel Gas
ANSI Z21.81-1997 CSA 6.25-M97	Cylinder Connection Devices	Fuel Gas
ANSI Z21.86-2000 CSA 2.32-2000	Vented Gas-Fired Space-Heating Appliances	Appliances
ANSI Z124.1-95	Plastic Bathtub Units	Fixtures
ANSI Z124.2-95	Plastic Shower Units	Fixtures
ANSI Z124.3-95	Plastic Lavatories	Fixtures
ANSI Z124.4-96	Plastic Water Closet Bowls and Tanks	Fixtures
ANSI Z124.5-97	Plastic Toilet (Water Closet) Seats	Fixtures
ANSI Z124.6-97	Plastic Sinks	Fixtures
ANSI Z124.7-97	Prefabricated Plastic Spa Shells	Fixtures
ANSI Z124.8-90	Plastic Bathtub Liners	Fixtures
ANSI Z124.9-94	Plastic Urinal Fixtures (Note 1)	Fixtures
ANSI Z223.1-99	National Fuel Gas Code (same as NFPA 54)	Fuel Gas
ANSI Z358.1-98	Emergency Eyewash and Shower Equipment	Miscellaneous
ARI 1010-94	Drinking Fountains and Self-Contained, Mechanically Refrigerated Drinking Water Coolers	Appliances
ASHRAE 90.1-2001	Energy Standard for Buildings Except Low-Rise Residential Buildings	Miscellaneous
ASME A112.1.2-96	Air Gaps in Plumbing Systems	Piping
ASME A112.1.3-2000	Air Gap Fittings for Use with Plumbing Fixtures, Appliances, and Appurtenances	Fixtures

Standard Number	Standard Title	Application
ASME A112.3.1-93	Stainless Steel Drainage Systems for Sanitary, Storm, and Chemical Applications, Above and Below Ground (Note 1)	Piping, Ferrous
ASME A112.3.4-2000	Macerating Toilet Systems and Related Components	Fixtures
ASME A112.4.1-93 (R98)	Water Heater Relief Valve Drain Tubes	Appliances
ASME A112.4.3-99	Plastic Fittings for Connecting Water Closets to the Sanitary Drainage System	Piping
ASME A112.6.1M-97	Floor-Affixed Supports for Off-the-Floor Plumbing Fixtures for Public Use	Fixtures
ASME A112.6.2-2000	Framing-Affixed Supports for Off-the-Floor Plumbing Fixtures	Fixtures
ASME A112.14.3-2001	Grease Interceptors	Fixtures
ASME A112.14.4-2001	Grease Recovery Devices	Fixtures
ASME A112.18.1M-2000	Plumbing Fixture Fittings	Valves
ASME A112.18.3-96	Backflow Protection Devices and Systems in Plumbing Fixture	Kitchen, Lavatory, and Shower Fittings with Attached Hose Outlets
ASME A112.18.6-99	Flexible Water Connectors	Piping
ASME A112.18.7-99	Deck Mounted Bath/Shower Transfer Valves with Integral Backflow Protection	Valves
ASME A112.19.1M-94 (R99)	Enameled Cast-Iron Plumbing Fixtures (Supplement 1-1998)	Fixtures
ASME A112.19.2M-98	Vitreous China Plumbing Fixtures	Fixtures
ASME A112.19.3M-2000	Stainless Steel Plumbing Fixtures (Designed for Residential Use)	Fixtures
ASME A112.19.4M-94 (R99)	Porcelain-Enameled Formed Steel Plumbing Fixtures (Supplement 1-1998)	Fixtures
ASME A112.19.5-99	Trim for Water-Closet Bowls, Tanks, and Urinals	Fixtures
ASME A112.19.6-95	Hydraulic Performance Requirements for Water Closets and Urinals	Fixtures
ASME A112.19.7M-95	Whirlpool Bathtub Appliances	Fixtures
ASME A112.19.8M-87 (R96)	Suction Fittings for Use in Swimming Pools, Wading Pools, Spas, Hot Tubs, and Whirlpool Bathtub Appliances	Swimming Pools and Spas
ASME A112.19.9M-91 (R98)	Non-Vitreous Ceramic Plumbing Fixtures	Fixtures
ASME A112.19.12-2000	Wall Mounted and Pedestal Mounted Adjustable and Pivoting Lavatory and Sink Carrier System	Fixtures
ASME A112.21.1M-91[D]	Floor Drains (Note 1) (replaced by ASME A112.6.3)	DWV Components
ASME A112.21.3M-85 (R01)	Hydrants for Utility and Maintenance Use (Note 1)	Valves
ASME A112.26.1M-84[D]	Water Hammer Arresters (cancelled)	Piping

Standard Number	Standard Title	Application
ASME A112.36.2M-91 (R98)	Cleanouts (Note 1)	DWV Components
ASME B1.20.1-83 (R92)	Pipe Threads, General Purpose, Inch	Joints
ASME B1.20.3-76 (R82/91/98)	Dryseal Pipe Threads, Inch	Joints
ASME B16.1-89	Cast-Iron Pipe Flanges and Flanged Fittings, Classes 25, 125, 250, and 800	Piping, Ferrous
ASME B16.3-99	Malleable-Iron Threaded Fittings	Piping, Ferrous
ASME B16.4-98	Gray Iron Threaded Fittings (Includes Revision Services)	Piping, Ferrous
ASME B16.5-96	Pipe Flanges and Flanged Fittings	Joints
ASME B16.12-98	Iron Threaded Drainage Fittings (Note 1)	Piping, Ferrous
ASME B16.15-85 (R94)	Cast Bronze Threaded Fittings, Classes 125 and 250	Piping, Copper Alloy
ASME B16.18-84	Cast Copper Alloy Solder Joint Pressure Fittings (Note 1)	Piping, Copper Alloy
ASME B16.21-92	Nonmetallic Flat Gaskets for Pipe Flanges	Joints
ASME B16.22-95	Wrought Copper and Copper Alloy Solder Joint Pressure Fittings Alloy	Piping, Copper Alloy
ASME B16.23-92	Cast Copper Alloy Solder Joint Drainage Fittings – DWV Alloy	Piping, Copper Alloy
ASME B16.24-2002	Cast Copper Alloy Pipe Flanges and Flanged Fittings Alloy	Piping, Copper Alloy
ASME B16.26-88	Cast Copper Alloy Fittings for Flared Copper Tubes Alloy	Piping, Copper Alloy
ASME B16.29-2002	Wrought Copper and Wrought Copper Alloy Solder Joint Drainage Fittings–DWV Alloy (Note 1)	Piping, Copper Alloy
ASME B16.32-92	Cast Copper Alloy Solder Joint Fittings for Solvent Drainage Systems Alloy	Piping, Copper Alloy
ASME B16.33-90	Manually Operated Metallic Gas Valves for Use in Gas Piping Systems up to 125 psig	Valves
ASME B16.34-96	Valves – Flanged, Threaded, and Welding End	Valves
ASME B16.38-85	Large Metallic Valves for Gas Distribution (Manually Operated, NPS 2-1/2 to 12, 125 psig Maximum)	Valves
ASME B16.39-98	Pipe Unions, Malleable Iron Threaded (Includes Revision Services)	Piping, Ferrous
ASME B16.47-96	Large Diameter Steel Flanges	Piping, Ferrous
ASME B36.10M-2000	Welded and Seamless Wrought Steel Pipe	Piping, Ferrous
ASME Section IX	Welding and Brazing Procedures, Welders, Brazers, and Welding and Brazing Operators	Certification
ASSE 1001-90	Pipe Applied Atmospheric-Type Vacuum Breakers	Backflow Protection
ASSE 1002-99	Anti-Siphon Fill Valves (Ballcocks) for Water Closet Flush Tank	Backflow Protection
ASSE 1003-2001	Water Pressure Reducing Valves	Valves

MANDATORY REFERENCED STANDARDS

Table 14-1

Standard Number	Standard Title	Application
ASSE 1004-90	Backflow Prevention Requirements for Commercial Dishwashing Machines	Backflow Protection
ASSE 1006-89	Residential Use Dishwashers	Appliances
ASSE 1007-92	Home Laundry Equipment	Appliances
ASSE 1008-89	Household Food Waste Disposer Units	Appliances
ASSE 1009-90	Commercial Food Waste Grinder Units	Appliances
ASSE 1010-98	Water Hammer Arresters	Piping
ASSE 1011-95	Hose-Connection Vacuum Breakers	Backflow Protection
ASSE 1013-99	Reduced Pressure Principle Backflow Preventers and Reduced Pressure Fire Protection Principle Backflow Preventers	Backflow Protection
ASSE 1014-90	Hand-Held Showers	Fixtures
ASSE 1015-99	Double-Check Backflow Prevention Assembly	Backflow Protection
ASSE 1016-96	Individual, Thermostatic Pressure Balancing and Combination Pressure Balancing and Thermostatic Control Valves for Individual Fixtures Fittings	Valves
ASSE 1017-98	Temperature Actuated Mixing Valves for Hot Water Distribution Systems	Valves
ASSE 1018-2001	Trap Seal Primer Valves, Water Supply Fed	Valves
ASSE 1019-97	Vacuum Breaker Wall Hydrant, Freeze-Resistant Automatic Draining Type	Backflow Protection
ASSE 1020-98	Pressure Vacuum Breaker Assembly	Backflow Protection
ASSE 1021-2001	Drains Air Gaps for Domestic Dishwasher Applications	Backflow Protection
ASSE 1023-79	Hot Water Dispensers, Household Storage Type, Electrical	Appliances
ASSE 1025-78	Diverters for Plumbing Faucets with Hose Spray, Anti-Siphon Type, Residential Applications	Valves
ASSE 1028-81[D]	Automatic Flow Controllers (discontinued)	Valves
ASSE 1032-80	Dual Check Valve Type Backflow Preventers for Carbonated Beverage Dispensers – Post Mix Types	Backflow Protection
ASSE 1034-81[D]	Fixed Flow Restrictors (discontinued)	Piping
ASSE 1035-95	Laboratory Faucet Backflow Preventer	Backflow Protection
ASSE 1037-90	Pressurized Flushing Devices (Flushometers) for Plumbing Fixtures	Backflow Protection
ASSE 1047-99	Reduced Pressure Detector Fire Protection Backflow Prevention Assemblies	Backflow Protection
ASSE 1052-94	Hose Connection Backflow Preventers	Backflow Protection
ASSE 1055-97	Chemical Dispensing Systems	Backflow Protection

Standard Number	Standard Title	Application
ASSE 1056-2001	Spill Resistant Vacuum Breakers	Backflow Protection
ASSE 1062-97	Temperature Actuated Flow Reduction (TAFR) Valves for Individual Fixture Fittings	Valves
ASSE 1066-97	Individual Pressure Balancing In-Line Valves for Individual Fixture Fittings (Note 9)	Valves
ASSE Series 5000-98	Professional Qualification Standard for Backflow Prevention Assembly Testers, Repairers, and Surveyors	Backflow Protection
ASSE 6000-98	Medical Gas Systems Installers, Inspectors, and Verifiers	Certification
ASTM A 47-99	Ferritic Malleable Iron Castings	Piping, Ferrous
ASTM A 53-2001	Pipe, Steel, Black and Hot-Dipped, Zinc-Coated, Welded, and Seamless	Piping, Ferrous
ASTM A 74-98	Cast-Iron Soil Pipe and Fittings (Note 1)	Piping, Ferrous
ASTM A 126-95(R01)	Gray Iron Castings for Valves, Flanges, and Pipe Fittings	Piping, Ferrous
ASTM A 197M-2000	Cupola Malleable Iron (Metric)	Piping, Ferrous
ASTM A 312-2001a	Seamless and Welded Austenitic Stainless Steel Pipes	Piping, Ferrous
ASTM A 377-99	Ductile-Iron Pressure Pipe	Piping, Ferrous
ASTM A 518-99	Corrosion-Resistant High-Silicon Iron Castings (Metric)	Piping, Ferrous
ASTM A 536-84(R-99 <sup>el</sup> )	Ductile Iron Castings	Piping, Ferrous
ASTM A 653M-2001a	Steel Sheet, Zinc-Coated (Galvanized) or Zinc-Iron Alloy-Coated (Galvannealed) by the Hot-Dip Process	Piping, Ferrous
ASTM A 733-2001	Welded and Seamless Carbon Steel and Austenitic Stainless Steel Pipe Nipples	Piping, Ferrous
ASTM A 861-2001a	High-Silicon Iron Pipe and Fittings (Note 1)	Piping, Ferrous
ASTM A 888-98 <sup>el</sup>	Hubless Cast-Iron Soil Pipe and Fittings for Sanitary and Storm Drain Waste and Vent Piping Applications	Piping, Ferrous
ASTM B 29-92(R97)	Refined Lead	Joints
ASTM B 32-96	Solder Metal (Note 4)	Joints
ASTM B 42-98	Seamless Copper Pipe, Standard Sizes	Piping, Copper Alloy
ASTM B 43-98	Seamless Red Brass Pipe, Standard Sizes	Piping, Copper Alloy
ASTM B 75-99	Seamless Copper Tube	Piping, Copper Alloy
ASTM B 88-99 <sup>el</sup>	Seamless Copper Water Tube	Piping, Copper Alloy
ASTM B 135-2000	Seamless Brass Tube (Metric)	Piping, Copper Alloy
ASTM B 152-2000	Copper Sheet, Strip, Plate, and Rolled Bar	Miscellaneous
ASTM B 251-97	General Requirements for Wrought Seamless Copper Copper-Alloy Tube	Piping, Copper Alloy

Standard Number	Standard Title	Application
ASTM B 280-99 <sup>e1</sup>	Seamless Copper Tube for Air Conditioning and Refrigeration Field Service	Piping, Copper Alloy
ASTM B 302-2000	Threadless Copper Pipe, Standard Sizes	Piping, Copper Alloy
ASTM B 306-99	Copper Drainage Tube (DWV)	Piping, Copper Alloy
ASTM B 370-98	Copper Sheet and Strip for Building Construction	Miscellaneous
ASTM B 447-2000	Welded Copper Tube	Piping, Copper Alloy
ASTM B 584-2000	Copper Alloy Sand Casting for General Applications (Note 5)	Piping, Copper Alloy
ASTM B 587-97 <sup>e1</sup>	Welded Brass Tube	Piping, Copper Alloy
ASTM B 641-93[D]	Seamless and Welded Copper Distribution Tube (Type D) (discontinued)	Piping, Copper Alloy
ASTM B 642-88[D]	Welded Copper Alloy UNS C21000 Water Tube (discontinued 1994)	Piping, Copper Alloy
ASTM B 687-99	Brass, Copper, and Chromium-Plated Pipe Nipples	Piping, Copper Alloy
ASTM B 716-93[D]	Welded Copper Water Tube (discontinued 1994)	Piping, Copper Alloy
ASTM B 813-2000 <sup>e1</sup>	Liquid and Paste Fluxes for Soldering Applications of Copper and Copper Alloy Tube	Joints
ASTM B 819-2000	Seamless Copper Tube for Medical Gas Systems	Piping, Copper Alloy
ASTM B 828-2000	Making Capillary Joints by Soldering of Copper and Copper Alloy Tube and Fittings	Joints
ASTM C 14-99	Concrete Sewer, Storm Drain, and Culvert Pipe	Piping, Non-Metallic
ASTM C 296-2000	Asbestos-Cement Pressure Pipe	Piping, Non-Metallic
ASTM C 412-99	Concrete Drain Tile	Piping, Non-Metallic
ASTM C 425-2002	Compression Joints for Vitrified Clay Pipe and Fittings	Joints
ASTM C 428-97(R02)	Asbestos-Cement Nonpressure Sewer Pipe (Notes 6 and 7)	Piping, Non-Metallic
ASTM C 443-2001	Joints for Circular Concrete Sewer and Culvert Pipe, Using Rubber Gaskets	Joints
ASTM C 478-97	Precast Reinforced Concrete Manhole Sections	Miscellaneous
ASTM C 564-97	Rubber Gaskets for Cast-Iron Soil Pipe and Fittings (Note 1)	Joints
ASTM C 700-2002	Vitrified Clay Pipe, Extra Strength, Standard Strength, and Perforated	Piping, Non-Metallic
ASTM C 1053-2000	Borosilicate Glass Pipe and Fittings for Drain, Waste, and Vent (DWV) Applications (Note 1)	Piping, Non-Metallic
ASTM C 1173-97	Flexible Transition Couplings for Underground Piping Systems	Joints
ASTM C 1277-97	Shielded Couplings Joining Hubless Cast-Iron Soil Pipe and Fittings	Piping, Ferrous



Standard Number	Standard Title	Application
ASTM C 1440-99 <sup>a1</sup>	Thermoplastic Elastomeric (TPE) Gasket Materials for Drain, Waste, and Vent (DWV), Sewer, Sanitary and Storm Plumbing Systems	Piping, Plastic
ASTM C 1460-2000	Shielded Transition Couplings for Use with Dissimilar DWV Pipe and Fittings Above Ground	Piping, Plastic
ASTM C 1461-2000	Mechanical Couplings Using Thermoplastic Elastomeric (TPE) Gaskets for Joining Drain, Waste, and Vent (DWV); Sewer; Sanitary; and Storm Plumbing Systems for Above and Below Ground	Piping, Plastic
ASTM D 396-2001	Specification for Fuel Oil	Miscellaneous
ASTM D 1527-99	Acrylonitrile-Butadiene-Styrene (ABS) Plastic Pipe, Sch. 40 and 80	Piping, Plastic
ASTM D 1785-99	Poly(Vinyl Chloride) (PVC) Plastic Pipe, Sch. 40, 80, and 120	Piping, Plastic
ASTM D 1869-95(R00)	Rubber O-rings for Asbestos-Cement Pipe	Joints
ASTM D 2104-2001	Polyethylene (PE) Plastic Pipe, Sch. 40	Piping, Plastic
ASTM D 2146-82[D]	Polypropylene Plastic Molding and Extrusion Materials (replaced by ASTM D 4101)	Piping, Plastic
ASTM D 2235-2001	Solvent Cement for Acrylonitrile-Butadiene-Styrene (ABS) Plastic Pipe and Fittings	Joints
ASTM D 2239-2001	Polyethylene (PE) Plastic Pipe, (SDR-PR) Based on Controlled Inside Diameter	Piping, Plastic
ASTM D 2241-2000	Poly(Vinyl Chloride)(PVC) Pressure-Rated Pipe (SDR Series)	Piping, Plastic
ASTM D 2282-99	Acrylonitrile-Butadiene-Styrene (ABS) Plastic Pipe (SDR-PR)	Piping, Plastic
ASTM D 2321-2000	Underground Installation of Thermoplastic Pipe for Sewers and Other Gravity-Flow Applications	Piping, Plastic
ASTM D 2447-2001	Polyethylene (PE) Plastic Pipe, Sch. 40 and 80 (Based on Controlled Outside Diameter)	Piping, Plastic
ASTM D 2464-99	Threaded Poly(Vinyl Chloride) (PVC) Plastic Pipe Fittings, Sch. 80 (Note 1)	Piping, Plastic
ASTM D 2465-73[D]	Threaded Acrylonitrile-Butadiene-Styrene (ABS) Plastic Pipe Fittings, Schedule 80 (discontinued 1986)	Piping, Plastic
ASTM D 2466-2001	Poly(Vinyl Chloride) (PVC) Plastic Pipe Fittings, Sch. 40 (Note 1)	Piping, Plastic
ASTM D 2467-2001	Poly(Vinyl Chloride) (PVC) Plastic Pipe Fittings, Sch, 80 (Note 1)	Piping, Plastic
ASTM D 2468-96a	Acrylonitrile-Butadiene-Styrene (ABS) Plastic Pipe Fittings (Sch. 40)	Piping, Plastic
ASTM D 2469-76[D]	Socket-Type Acrylonitrile-Butadiene-Styrene (ABS) Plastic Pipe Fittings, Schedule 80 (discontinued 1986)	Piping, Plastic

Standard Number	Standard Title	Application
ASTM D 2513-2001a	Thermoplastic Gas Pressure Pipe Tubing and Fittings (Note 1)	Piping, Plastic
ASTM D 2517-2000	Reinforced Epoxy Resin Gas Pressure Pipe and Fittings	Piping, Plastic
ASTM D 2564-96a	Solvent Cements for Poly(Vinyl Chloride) (PVC) Plastic Piping Systems	Joints
ASTM D 2609-2000	Plastic Insert Fittings for Polyethylene (PE) Plastic Pipe (Note 1)	Piping, Plastic
ASTM D 2657-97	Practice for Heating Fusion Joining of Polyolefin Pipe Fittings (Note 1)	Joints
ASTM D 2661-2001	Acrylonitrile-Butadiene-Styrene (ABS) Sch.40 Plastic Drain, Waste, and Vent Pipe and Fittings (Note 1)	Piping, Plastic
ASTM D 2665-2001	Poly(Vinyl Chloride) (PVC) Plastic Drain, Waste, and Vent Pipe and Fittings	Piping, Plastic
ASTM D 2672-96a	Joints for IPS PVC Pipe Using Solvent Cement	Joints
ASTM D 2680-2001	Acrylonitrile-Butadiene-Styrene (ABS) and Poly(Vinyl Chloride) (PVC) Composite Sewer Piping	Piping, Plastic
ASTM D 2729-96a	Poly(Vinyl Chloride) (PVC) Sewer Pipe and Fittings (Note 1)	Piping, Plastic
ASTM D 2737-2001	Polyethylene (PE) Plastic Tubing	Piping, Plastic
ASTM D 2740-89 <sup>e1</sup> [D]	Poly(Vinyl Chloride) (PVC) Plastic Tubing (discontinued 1991)	Piping, Plastic
ASTM D 2751-96a	Acrylonitrile-Butadiene-Styrene (ABS) Sewer Pipe and Fittings (Note 1)	Piping, Plastic
ASTM D 2846-99	Chlorinated Poly(Vinyl Chloride) (CPVC) Plastic Hot- and Cold-Water Distribution Systems	Piping, Plastic
ASTM D 2855-96	Making Solvent-Cemented Joints with Poly(Vinyl Chloride) (PVC) Pipe and Fittings	Joints
ASTM D 2996-2001	Filament-Wound Fiberglass (Glass-Fiber-Reinforced Thermosetting Resin) Pipe	Piping, Plastic
ASTM D 3033-85[D]	Type PSP Poly(Vinyl Chloride) (PVC) Sewer Pipe and Fittings (discontinued 1989)	Piping, Plastic
ASTM D 3034-2001	Type PSM Poly(Vinyl Chloride) (PVC) Sewer Pipe and Fittings	Piping, Plastic
ASTM D 3035-2001	Polyethylene(PE) Plastic Pipe (DR-PR) (Based on Controlled Outside Diameter)	Piping, Plastic
ASTM D 3036-73[D]	Poly(Vinyl Chloride) (PVC) Plastic Line Couplings (discontinued 1986)	Piping, Plastic
ASTM D 3122-95	Solvent Cements for Styrene-Rubber (SR) Plastic Pipe and Fittings	Joints
ASTM D 3138-95	Solvent Cements for Transition Joints, Acrylonitrile-Butadiene-Styrene (ABS) and Poly(Vinyl Chloride) (PVC) Non-Pressure Piping Components	Joints
ASTM D 3139-98	Joints for Plastic Pressure Pipes Using Flexible Elastomeric Seals	Joints

Standard Number	Standard Title	Application
ASTM D 3140-90[D]	Flaring Polyolefin Pipe and Tubing (discontinued)	Joints
ASTM D 3212-96a	Joints for Drain and Sewer Plastic Pipes Using Flexible Elastomeric Seals	Joints
ASTM D 3298-81[D]	Perforated Styrene-Rubber (SR) Plastic Drain Pipe (discontinued 1989)	Piping, Plastic
ASTM D 3311-94	Drain, Waste, and Vent (DWV) Plastic Fittings Patterns (Note 1)	Piping, Plastic
ASTM D 3965-99	Rigid Acrylonitrile-Butadiene-Styrene (ABS) Materials for Pipe and Fittings	Piping, Plastic
ASTM D 4068-2001	Chlorinated Polyethylene (CPE) Sheeting for Concealed Water-Containment Membrane	Fixtures
ASTM D 4101-2002	Propylene Plastic Injection and Extrusion Materials	Miscellaneous
ASTM D 4551-96 (R01)	Poly(Vinyl Chloride) (PVC) Plastic Flexible Concealed Water-Containment Membrane	Fixtures
ASTM D 6104-97	Determining the Performance of Oil/Water Separators Subjected to Surface Run-Off	Fixtures
ASTM E 84-2001	Surface Burning Characteristics of Building Materials	Miscellaneous
ASTM E 119-2000a	Fire Tests of Building Construction and Materials	Miscellaneous
ASTM E 814-2000	Fire Tests of Through-Penetration Fire Stops	Miscellaneous
ASTM F 402-98 (R99)	Safe Handling of Solvent Cements, Primers, and Cleaners Used for Joining Thermoplastic Pipe and Fittings	Joints
ASTM F 405-98	Corrugated polyethylene (PE) Tubing and Fittings	Piping, Plastic
ASTM F 409-99a	Thermoplastic Accessible and Replaceable Plastic Tube and Tubular Fittings (Note 1)	Piping, Plastic
ASTM F 437-99	Threaded Chlorinated Poly(Vinyl Chloride) (CPVC) Plastic Pipe Fittings, Sch. 80	Piping, Plastic
ASTM F 438-2001	Socket-Type Chlorinated Poly(Vinyl Chloride) (CPVC) Plastic Pipe Fittings, Sch. 40	Piping, Plastic
ASTM F 439-2001	Socket-Type Chlorinated Poly(Vinyl Chloride) (CPVC) Plastic Pipe Fittings, Sch. 80	Piping, Plastic
ASTM F 441-99	Chlorinated Poly(Vinyl Chloride) (CPVC) Plastic Pipe, Sch. 40 and 80	Piping, Plastic
ASTM F 442-99	Chlorinated Poly(Vinyl Chloride) (CPVC) Plastic Pipe (SDR-PR)	Piping, Plastic
ASTM F 443-77 <sup>e1</sup> [D]	Bell-End Chlorinated Poly(Vinyl Chloride) (CPVC) Pipe, Schedule 40 (discontinued 1987)	Piping, Plastic
ASTM F 480-2000	Thermoplastic Well Casing Pipe and Couplings Made in Standard Dimension Ratios (SDR) Schedule 40 and Schedule 80	Piping, Plastic

Standard Number	Standard Title	Application
ASTM F 493-97	Solvent Cements for Chlorinated Poly(Vinyl Chloride) (CPVC) Plastic Pipe and Fittings	Joints
ASTM F 628-2001	Acrylonitrile-Butadiene-Styrene (ABS) Sch. 40 Plastic Drain, Waste, and Vent Pipe with a Cellular Core, (Note 1)	Piping, Plastic
ASTM F 656-96a	Primers for Use in Solvent Cement Joints of Poly(Vinyl Chloride) (PVC) Plastic Pipe and Fittings	Joints
ASTM F 667-97	Large Diameter Corrugated Polyethylene Tubing and Fittings	Piping, Plastic
ASTM F 714-2001	Polyethylene (PE) Plastic Pipe (SDR-PR) (Based on Outside Diameter)	Piping, Plastic
ASTM F 789-95a	Type PS-46 and Type PS-115 Poly(Vinyl Chloride) (PVC) Plastic Gravity Flow Sewer Pipe and Fittings (Note 1)	Piping, Plastic
ASTM F 794-2001	Poly(Vinyl Chloride) (PVC) Profile Gravity Sewer Pipe and Fittings Based on Controlled Inside Diameter	Piping, Plastic
ASTM F 810-2001	Smoothwall Polyethylene (PE) Pipe for Use in Drainage and Waste Disposal Absorption Fields	Piping, Plastic
ASTM F 876-2001 <sup>el</sup>	Crosslinked Polyethylene (PEX) Tubing	Piping, Plastic
ASTM F 877-2001 <sup>el</sup>	Crosslinked Polyethylene (PEX) Plastic Hot- and Cold-Water Distribution Systems	Piping, Plastic
ASTM F 891-2000	Coextruded Poly(Vinyl Chloride) (PVC) Plastic Pipe with a Cellular Core	Piping, Plastic
ASTM F 949-2001a	Poly(Vinyl Chloride) (PVC) Corrugated Sewer Pipe with a Smooth Interior and Fittings	Piping, Plastic
ASTM F 1216-98	Rehabilitation of Existing Pipelines and Conduits by the Inversion and Curing of a Resin-Impregnated Tube	Piping, Plastic
ASTM F 1281-2001a	Crosslinked Polyethylene / Aluminum / Crosslinked Polyethylene (PEX-Al-PEX) Pressure Pipe	Piping, Plastic
ASTM F 1282-2001a	Polyethylene / Aluminum / Polyethylene (PE-Al-PE) Composite Pressure Pipe	Piping, Plastic
ASTM F 1412-2001	Polyolefin Pipe and Fittings for Corrosive Waste Drainage Systems	Piping, Plastic
ASTM F 1673-95	Polyvinylidene Fluoride (PVDF) Corrosive Waste Drainage Systems	Piping, Plastic
ASTM F 1743-96	Rehabilitation of Existing Pipelines and Conduits by Pulled-in-Place Installation of Cured-in-Place Thermosetting Resin Pipe (CIPP)	Piping, Plastic
ASTM F 1807-99	Metal Insert Fittings with Copper Crimp Ring for SDR 9 Crosslinked Polyethylene (PEX) Tubing	Piping, Plastic
ASTM F 1866-98	Poly(Vinyl Chloride) (PVC) Drainage and DWV Fabricated Fittings, Schedule 40	Piping, Plastic
ASTM F 1924-2001	Plastic Mechanical Fitting for Use on Outside Diameter Controlled Polyethylene Gas Distribution Pipe and Tubing	Piping, Plastic

Standard Number	Standard Title	Application
ASTM F 1948-99a	Metallic Mechanical Fittings for Use on Outside Diameter Controlled Thermoplastic Gas Distribution Pipe and Tubing	Piping, Plastic
ASTM F 1960-2000 <sup>e1</sup>	Cold Expansion Fittings with PEX Reinforcing Rings for Use with Cross-Linked Polyethylene (PEX) Tubing	Piping, Plastic
ASTM F 1961-99	Metal Cold Flare Compression Fittings with Disc Springs for Crosslinked Polyethylene (PEX) Tubing	Piping, Plastic
ASTM F 1970-2001	Special Engineered Fittings or Appurtenances for Use in Poly (Vinyl Chloride) (PVC) or Chlorinated Poly(Vinyl Chloride) (CPVC) Systems	Piping, Plastic
ASTM F 1973-99 <sup>e1</sup>	Factory Assembled Anodeless Riser and Transition Fitting in Polyethylene (PE) Fuel Gas Distribution Systems	Piping, Plastic
ASTM F 1974-2000 <sup>e1</sup>	Metal Insert Fittings for Polyethylene/ Aluminum/ Polyethylene and Crosslinked Polyethylene/ Aluminum/ Crosslinked Polyethylene Composite Pressure Pipe	Piping, Plastic
ASTM F 2080-2001	Cold-Expansion Fittings With Metal Compression Sleeves for Cross-Linked Polyethylene (PEX) Pipe	Piping, Plastic
AWS A5.8-92	Filler Metals for Brazing and Braze Welding	Joints
AWS B2.2-91	Brazing Procedure and Performance Qualification	Certification
AWWA C110-98	Ductile-Iron and Gray-Iron Fittings, 3 in. through 48 in. (75 mm through 1200 mm), for Water and Other Liquids (same as ANSI A21.10-98)	Piping, Ferrous
AWWA C111-2000	Rubber-Gasket Joints for Ductile-Iron Pressure Pipe and Fittings (same as ANSI A21.11-00)	Piping, Ferrous
AWWA C151-96	Ductile-Iron Pipe, Centrifugally Cast, for Water (same as ANSI A21.51-91)	Piping, Ferrous
AWWA C153-2000	Ductile-Iron Compact Fittings, 3 in. through 24 in. (76 mm through 610 mm) and 54 in. through 64 in. (1400 mm through 1600 mm), for Water Service (same as ANSI A21.53-00)	Piping, Ferrous
AWWA C203-91a	Coal-Tar Protective Coatings and Linings for Steel Water Pipelines – Enameled and Tape – Hot Applied	Piping
AWWA C213-2001	Fusion-Bonded Epoxy Coating for the Interior and Exterior of Steel Water Pipelines	Piping, Ferrous
AWWA C215-99	Extruded Polyolefin Coatings for the Exterior of Steel Water Pipelines	Piping, Ferrous
AWWA C400-93	Asbestos-Cement Distribution Pipe, 4 in. through 16 in. (100 mm through 400 mm) for Water Distribution Systems	Piping, Non-Metallic
AWWA C500-93	Gate Valves for Water and Sewerage Systems Valves	Valves
AWWA C504-2000	Rubber-Seated Butterfly Valves	Valves
AWWA C507-99	Ball Valves, 6 in. through 48 in. (150 mm through 1200 mm)	Valves

Standard Number	Standard Title	Application
AWWA C510-97	Double Check Valve Backflow-Prevention Assembly	Backflow Protection
AWWA C511-97	Reduced-Pressure Principle Backflow-Prevention Assemblies	Backflow Protection
AWWA C606-97	Grooved- and Shouldered-Type Joints	Joints
AWWA C900-97	Poly(vinyl Chloride) (PVC) Pressure Pipe, 4 in. through 12 in., for Water Distribution	Piping, Plastic
AWWA C901-97	Polyethylene (PE) Pressure Pipe and Tubing, 1/2 in. (13 mm) through 3 in. (76 mm), for Water Service	Piping, Plastic
AWWA C902-96	Polybutylene (PB) Pipe, Tubing, and Fittings, 1/2 in. Through 3 in., for Water	Piping, Plastic
CISPI 301-2000	Hubless Cast-Iron Soil Pipe and Fittings for Sanitary and Storm Drain, Waste, and Vent Piping Applications (Note 1)	Piping, Ferrous
CISPI HSN-85[D]	Neoprene Rubber Gaskets for Hub and Spigot Cast-Iron Soil Pipe and Fittings (discontinued)	Joints
CISPI 310-97	Couplings for Use in Connection with Hubless Cast-Iron Soil Pipe and Fittings for Sanitary and Storm Drain, Waste, and Vent Piping Applications	Joints
CSA 3-92	U.S. Requirements for Excess Flow Valves	Valves
FS A-A-51145C	Flux, Soldering, Non-Electronic, Paste, and Liquid	Joints
FS K65.59-71	Acrylonitrile-Butadiene-Styrene (ABS) Sewer Pipe and Fittings	Piping, Plastic
FS M265-811	Acrylonitrile-Butadiene-Styrene (ABS) Sch. 40 Plastic Drain, Waste, and Vent Pipe and Fittings	Piping, Plastic
FS O-F-499D-85	Flux Brazing	Joints
FS O-F-506C-72[D]	Flux, Soldering (discontinued)	Joints
FS OO-L-201 f-70	Shower Pans—Sheet Lead, Grade B (4 lb. min.)	Miscellaneous
FS QQ-R-571C-69[D]	Copper and Nickel Alloys (Rods) (discontinued)	Miscellaneous
FS TT-S-1732-71[D]	Seal Compound Pipe Joint and Thread (discontinued)	Joints
FS WW-P 325B-76	Lead Pipe and Bends	Piping
FS WW-P-541-E-Gen. 1980	Plumbing Fixtures, General Specification	Fixtures
FS WW-U-516A-74(b)	Copper Alloy (Bronze) Unions	Piping, Copper Alloy
FS WW-V-54d[D]	Valve, Gate, Bronze (125, 150, and 200 lb., Screwed Flange, Solder-End, for Land Use) (discontinued)	Valves
FS WW-V-58b	Valves, Gate, Cast Iron (125 and 250 lb), Screwed and Flanged (for Land Use)	Valves
IAPMO PS 1-2000a	Prefabricated Septic Tanks	DWV Components
IAPMO PS 2-2000a	Cast Brass and Tubing P-Traps	Piping, Copper Alloy

Table 14-1

## UNIFORM PLUMBING CODE

Standard Number	Standard Title	Application
IAPMO PS 4-2000e1	Drains for Prefabricated and Precast Showers	Fixtures
IAPMO PS 7-84	Tubing Trap Wall Adapters	DWV Components
IAPMO PS 9-84	Diversion Tees and Twin Waste Elbows	DWV Components
IAPMO PS 14-99	Flexible Metallic Water Connectors	Piping
IAPMO PS 16-2000	Subdrains for Built-Up Shower Pans	Fixtures
IAPMO PS 23-89	Dishwasher Drain Air Gaps	Backflow Protection
IAPMO PS 25-84	Fittings for Joining Polyethylene Pipe for Water Service and Yard Piping	Joints
IAPMO PS 31-95	Backflow Prevention Assemblies	Backflow Protection
IAPMO PS 34-96	Polyethylene Encasement Sleeve for Potable Water Pipe and Tubing	Piping
IAPMO PS 36-90	Lead-Free Sealing Compounds for Threaded Joints	Joints
IAPMO PS 37-90	Black Plastic PVC or PE Pressure-Sensitive Corrosion Preventive Tape	Piping
IAPMO PS 38-99	ABS and PVC Backwater Valves	DWV Components
IAPMO PS 40-2001	Anodeless Transition Riser for Use with PVC Gas Yard Piping	Fuel Gas
IAPMO PS 41-99	Copper and Other Metallic Roof/Deck/Balcony Drains	DWV Components
IAPMO PS 42-96	Pipe Alignment and Secondary Support Systems	Piping
IAPMO PS 43-91	Cushioned Bathtubs and Whirlpool Bathtub Appliances	Fixtures
IAPMO PS 45-91	Bathtub Three-Way Diverter Valves with Backflow Protection	Valves
IAPMO PS 47-2002	Plastic Roof Drains	DWV Components
IAPMO PS 48-2000	Material Safety Data Verification for Plumbing Products	Miscellaneous
IAPMO PS 49-92	Backflow Prevention Requirements for Fixture Fittings with Hose Connected Singular Moveable Outlets	Backflow Protection
IAPMO PS 50-92	Dual Flush Devices For Water Closets	Fixtures
IAPMO PS 51-98	Plastic and Metallic Expansion Joints	Joints
IAPMO PS 52-99e1	Sumps and Sewage Ejector Tanks	DWV Components
IAPMO PS 53-92	Grooved Mechanical Pipe Couplings and Grooved End Fittings	Joints
IAPMO PS 54-2001a	Metallic and Plastic Utility Boxes	Miscellaneous
IAPMO PS 55-92	Bathwaste Strainer Drains	Fixtures
IAPMO PS 57-92	PVC Hydraulically Actuated Diaphragm Type Water Control Valves	Valves
IAPMO PS 58-92	Supports for Off-the-Floor Plumbing Fixtures With or Without Concealed Tanks	Fixtures

Standard Number	Standard Title	Application
IAPMO PS 59-92	Septic Effluent and Waste Water Diverter Valves	DWV Components
IAPMO PS 60-96	Sewage Holding Tank Containing Sewage Ejector Pump for Direct-Mounted Water Closet	DWV Components
IAPMO PS 61-92	Fabricated Stainless Steel Security Water Closets	Fixtures
IAPMO PS 62-93[D]	Enameled Cast-Iron Sanitary Floor Sinks (replaced by ASME A112.6.7)	Fixtures
IAPMO PS 63-99a	Plastic Leaching Chambers	DWV Components
IAPMO PS 64-98	Pipe Flashings	Piping
IAPMO PS 65-2000	Air Gap Units for Water Conditioning Equipment Installation	Backflow Protection
IAPMO PS 66-2000	Dielectric Waterway Fittings	Piping
IAPMO PS 67-93	Early-Closure Replacement Flappers or Early-Closure Replacement Flapper With Mechanical Assemblies	Fixtures
IAPMO PS 69-2001	Plastic Bathwaste and Overflow Assemblies	Piping, Plastic
IAPMO PS 70-2001	Bathtub/Whirlpool Bathtubs with Pressure Sealed Doors	Fixtures
IAPMO PS 71-2000[D]	Electronic-Controlled Showers (superseded by ASME A112.19.15)	Fixtures
IAPMO PS 72-2000	Valves with Atmospheric Vacuum Breakers	Valves
IAPMO PS 73-93	Dental Vacuum Pumps	Miscellaneous
IAPMO PS 76-95	Ballcock or Flushometer Valve Tailpiece Trap Primers and Trap Primer Receptors/Adapters	DWV Components
IAPMO PS 77-99[D]	Electrohydraulic Water Closets (replaced by ASME A112.19.13)	Fixtures
IAPMO PS 78-2001	Dual Flush for Electrohydraulic and Gravity Water Closet 6 Liter (1.6 Gallon)	Fixtures
IAPMO PS 79-95	Multiport Electronic Trap Primer	DWV Components
IAPMO PS 80-95e1	Grease Interceptors and Clarifiers	DWV Components
IAPMO PS 81-2000	Precast Concrete Seepage Pit Liners and Covers	DWV Components
IAPMO PS 82-95	Fiberglass (Glass Fiber Reinforced Thermosetting Resin) Fittings	Piping, Plastic
IAPMO PS 83-95[D]	Epoxy-Coated Cast-Iron Sanitary Floor Sinks (replaced by ASME A112.6.7)	Fixtures
IAPMO PS 84-95[D]	PVC Plastic Sanitary Floor Sinks (replaced by ASME A112.6.7)	Fixtures
IAPMO PS 85-95	Tools for Mechanically Formed Tee Connections in Copper Tubing	Piping
IAPMO PS 86-95	Rainwater Diverter Valve for Non-Roofed Area Slabs	DWV Components
IAPMO PS 87-95	Diverter and Shutoff Valves for Pool/Spas	Valves



Standard Number	Standard Title	Application
IAPMO PS 88-95	Pre-Pressurized Potable Water Tanks	Miscellaneous
IAPMO PS 89-95	Soaking and Hydrotherapy (Whirlpool) Bathtubs with Hydraulic Seatlift	Fixtures
IAPMO PS 90-95	Elastomeric Test Caps/Cleanout Caps	DWV Components
IAPMO PS 91-95	Plastic Stabilizers for Use with Plastic Closet Bends	Piping, Plastic
IAPMO PS 92-95	Heat Exchangers	Miscellaneous
IAPMO PS 93-2000	Water Closet Seats with Spray	Fixtures
IAPMO PS 94-2001a	P-Trap, Supply Stop, and Riser Insulated Protector	Miscellaneous
IAPMO PS 95-2001	Drain, Waste, and Vent Hangers and Plastic Pipe Support Hooks	Piping
IAPMO PS 96-96	Passive Direct Solar Water Heaters	Miscellaneous
IAPMO PS 97-2001	Mechanical Cast-Iron Closet Flanges	Piping, Ferrous
IAPMO PS 98-96	Prefabricated Fiberglass Church Baptisries	Fixtures
IAPMO PS 99-96	Terrazzo Plumbing Fixtures	Fixtures
IAPMO PS 100-96	Porous Filter Protector for Subdrain Weep Holes	DWV Components
IAPMO PS 101-97	Suction Relief Valves	Valves
IAPMO PS 102-97	Short Pattern Fixture Trap	DWV Components
IAPMO PS 103-97	Water Heater Stands With or Without Pans	Appliances
IAPMO PS 104-97	Pressure Relief Connection for Dispensing Equipment	Valves
IAPMO PS 105-97	Polyethylene Distribution Boxes	DWV Components
IAPMO PS 106-98	Prefabricated, Tileable Shower Receptors	Fixtures
IAPMO PS 107-98	Aramid-Reinforced Rubber Hose for Use in Non-Potable Water Radiant Heating and Snow Melting	Piping, Plastic
IAPMO PS 108-98	Restaurant Fire Suppression Systems	Appliances
IAPMO PS 110-99	PVC Cold Water Compression Fittings	Fittings
IAPMO PS 111-99	PVC Cold Water Gripper Fittings	Fittings
IAPMO PS 112-99	PVC Plastic Valves for Cold Water Distribution Systems Outside a Building and CPVC Plastic Valves for Hot and Cold Water Distribution Systems	Valves
IAPMO PS 113-99e1	Hydraulically Powered Household Food Waster Grinders	Appliances
IAPMO PS 114-99e1	Remote, Floor Box Industrial Water Supply, Air Supply, Drainage	Miscellaneous
IAPMO PS 115-99	Demand or Automatic Activated Hot Water Pumping Systems	Miscellaneous
IAPMO PS 116-99	Hot Water Circulating Devices Which Do Not Use a Pump	Miscellaneous
IAPMO PS 117-2001	Press Type Copper and Copper Alloy Fittings for Installation on Copper Tubing	Fittings

Standard Number	Standard Title	Application
IAPMO PS 118-2000	FOG (Fats, Oils, Greases) Disposal Systems	DWV Components
IAMPO PS 119-2000	Water Energized Sump Pump	Miscellaneous
IAS LC 1-99 CSA 6.26-M99	Fuel Gas Piping Systems Using Corrugated Stainless Steel Tubing (CSST) Fuel Gas	Fuel Gas
ISO Guide 65-1996	General Requirements for Bodies Operating Product Certification Systems	Certification
MIL-F-1183 H-83[D]	Fittings, Pipe, Cast Bronze, Silver-Brazing (discontinued)	Piping, Copper Alloy
MIL-F-18180C1	Flanges and Flanged Fittings, Pipe, Steel (150, 300, 400, 600, 900, 1500, and 2500 pounds)	Piping, Ferrous
MIL-P-17552F	Pumps, Centrifugal, Water, Horizontal, General Service; and Pumps, Centrifugal Water, Horizontal, Boiler-Feed; Electric Motor or Steam Driven	Pumps
MIL-P-21251E	Pumping Units, Sewage, Duplex, Automatic, Wet-Pit-Type (Superseded by FS A-A-50555)	Pumps
MIL-P-22561-82[D]	Glass (standard cancelled per Department of Defense)	Miscellaneous
MIL-P-52407 (A)-1976[D]	Pump, Centrifugal: Electric-Motor-Driven, Shallow Well (for Water) (discontinued)	Pumps
MIL-P-62156 (1)-1983[D]	Submersible, Axial Flow, Electric-Motor-Driven (discontinued)	Pumps
MIL-P-B-81[D] SSPMA-85	Sewage Pumps (discontinued)	Pumps
MIL-V-29193-80[D]	Pressurized Flushing Devices (discontinued)	Fixtures
MSS SP-25-98	Standard Marking System for Valves, Fittings, Flanges, and Unions	Piping
MSS SP-42-99	Class 150 Corrosion-Resistant Gate-Globe, Angle, and Check Valves with Flanged and Butt Weld Ends	Piping, Ferrous
MSS SP-44-96	Steel Pipeline Flanges	Piping, Ferrous
MSS SP-58-93	Pipe Hangers and Supports – Materials, Design, and Manufacture	Piping
MSS SP-67-95	Butterfly Valves	Valves
MSS SP-70-98	Cast-Iron Gate Valves, Flanged and Threaded Ends	Valves
MSS SP-71-97	Cast-Iron Swing Check Valves, Flanged and Threaded Ends	Valves
MSS SP-72-99	Ball Valves with Flanged or Butt-Welding Ends for General Service	Valves
MSS SP-73-91	Brazing Joints for Wrought and Cast Copper Alloy Solder Joint Pressure Fittings	Joints
MSS SP-78-98	Cast-Iron Plug Valves, Flanged and Threaded Ends	Valves
MSS SP-80-97	Bronze Gate-Globe, Angle, and Check Valves	Valves
MSS SP-83-2001	Class 300 Steel Pipe Unions Socket-Welding and Threaded	Piping, Ferrous
MSS SP-84 [D]	Steel Valves – Socket-Welding Ends and Threaded Ends (discontinued)	Valves

Table 14-1

## UNIFORM PLUMBING CODE

Standard Number	Standard Title	Application
NFPA 13R-99	Installation of Sprinkler Systems in Residential Occupancies up to and Including Four Stories in Height	Miscellaneous
NFPA 13D-99	Installation of Sprinkler Systems in One- and Two-Family Dwellings and Manufactured Homes	Miscellaneous
NFPA 31-2001	Installation of Oil-Burning Equipment	Miscellaneous
NFPA 54-2002	National Fuel Gas Code (same as ANSI Z223.1)	Fuel Gas
NFPA 58-2001	Storage and Handling of Liquefied Petroleum Gases	Fuel Gas
NFPA 85-2001	Boiler and Combustion Systems Hazards Code	Appliances
NFPA 99-2002	Health Care Facilities	Piping
NFPA 99C-2002	Gas and Vacuum Systems	Piping
NFPA 211-2000	Chimneys, Fireplaces, Vents, and Solid Fuel-Burning Appliances	Miscellaneous
NSF 3-2001	Commercial Spray-Type Dishwashing and Glasswashing Machines	Appliances
NSF 12-93	Automatic Ice Making Equipment	Appliances
NSF 14-2002	Plastic Piping Components and Related Materials	Piping, Plastic
NSF 18-96a	Manual Food and Beverage Dispensing Equipment	Appliances
NSF 24-96	Plumbing System Components for Manufactured Homes and Recreational Vehicles	Miscellaneous
NSF 29-93	Chemical Feeders for Commercial Dishwashers	Appliances
NSF 40-2000	Residential Wastewater Treatment Systems	DWV Components
NSF 41-99	Non-Liquid Saturated Treatment Systems	DWV Components
NSF 42-2002	Drinking Water Treatment Units—Aesthetic Effects	Appliances
NSF 44-2002	Residential Cation Exchange Water Softeners	Appliances
NSF 46-2000	Evaluation of Components and Devices Used in Wastewater Treatment Systems	DWV Components
NSF 53-2002	Drinking Water Treatment Units—Health Effects	Appliances
NSF 58-2002	Reverse-Osmosis Drinking Water Treatment Systems	Appliances
NSF 61-2001	Drinking Water System Components—Health Effects	Miscellaneous
NSF 62-99	Water Distillation Systems	Appliances
NSPI 1-1991	Public Swimming Pools	Swimming Pools and Spas
PDI G-101-85	Testing and Rating Procedure for Grease Interceptors with Appendix of Sizing and Installation Data	DWV Components
PDI-WH 201-92	Water Hammer Arresters	Piping
SAE J1670-93	Type F Clamps for Plumbing Applications	Joints
SAMA LF6a	Medical Care Facility Brassware	Miscellaneous
UL 80-96	Steel Inside Tanks for Oil-Burner Fuel	Miscellaneous
UL 103-95	Factory-Built Chimneys for Residential Type and Building Heating Appliances	Miscellaneous

Standard Number	Standard Title	Application
UL 125-97	Valves for Anhydrous Ammonia and LPG (Other than Safety Relief)	Valves
UL 132-97	Safety Relief Valves for Anhydrous Ammonia and LPG	Valves
UL 144-99	LPG Regulators	Valves
UL 174-96	Household Electric Storage Tank Water Heaters	Appliances
UL 343-97	Pumps for Oil-Burning Appliances	Pumps
UL 352-97	Constant-Level Oil Valves	Valves
UL 378-93	Draft Equipment	Miscellaneous
UL 399-93	Drinking-Water Coolers	Appliances
UL 430-94	Waste Disposers	Appliances
UL 441-96	Gas Vents	Miscellaneous
UL 443-95	Steel Auxiliary Tanks for Oil-Burner Fuel	Miscellaneous
UL 499-97	Electrical Heating Appliances	Appliances
UL 563-95	Ice Makers	Appliances
UL 569-95	Pigtails and Flexible Hose Connectors for LP-Gas	Fuel Gas
UL 723-96	Standard Test for Surface Burning Characteristics of Building Materials	Miscellaneous
UL 726-95	Oil-Fired Boiler Assemblies	Appliances
UL 732-95	Oil-Fired Storage Tank Water Heaters	Appliances
UL 749-97	Household Dishwashers	Appliances
UL 778-96	Motor-Operated Water Pumps	Pumps
UL 834-95	Heating, Water Supply, and Power Boilers—Electric	Appliances
UL 921-96	Commercial Electric Dishwashers	Appliances
UL 1453-95	Electric Booster and Commercial Storage Tank Water Heaters	Appliances
→ WQA S-300-91	Point-of-Use Low Pressure Reverse Osmosis Drinking Water Systems	Appliances
3-GP-28	Fuel Oil, Canadian Government Specification Board	Miscellaneous

Notes:

- 1 Although this standard is referenced in Table 14-1, some of the pipe, tubing, fittings, valves, or fixtures included in the standard are not acceptable for use under the provisions of the Uniform Plumbing Code.
- 4 See Section 316.1.3 for restriction.
- 5 Alloy C85200 for cleanout plugs.
- 6 Limited to domestic sewage.
- 7 Type II only.
- 9 ASSE 1066 is not intended to limit the maximum outlet temperature at point of use.
- 10 See Section 315.0 for trenching, excavation, and backfilling requirements when installing building drains and sewers. Engineers may wish to consult ASTM D 2321 when preparing plans and specifications for sewer mains or specific projects.

## TABLE 14-1 INDEX

Standards for Materials, Equipment,  
Joints, and Connections

Standard Number	page	Backflow Protection	
<b>Appliances</b>			
AHAM DW-1-92.....	211	ASSE 1001-90.....	214
AHAM DW-2PR-92.....	211	ASSE 1002-99.....	214
AHAM FWD-1-92.....	211	ASSE 1004-90.....	215
AHAM HLW-2 PR-86.....	211	ASSE 1011-95.....	215
ANSI Z21.10.1-98.....	212	ASSE 1013-99.....	215
ANSI Z21.10.3-2001.....	212	ASSE 1015-99.....	215
ANSI Z21.12-90.....	212	ASSE 1019-97.....	215
ANSI Z21.13-2000.....	212	ASSE 1020-98.....	215
ANSI Z21.24-2001.....	212	ASSE 1021-2001.....	215
ANSI Z21.69-97•CSA 6.16-M97.....	212	ASSE 1032-80.....	215
ANSI Z21.86-2000•CSA 2.32-2000.....	212	ASSE 1035-95.....	215
ARI 1010-94.....	212	ASSE 1037-90.....	215
ASME A112.4.1-93(R98).....	213	ASSE 1047-99.....	215
ASSE 1006-89.....	215	ASSE 1052-94.....	215
ASSE 1007-92.....	215	ASSE 1055-97.....	215
ASSE 1008-89.....	215	ASSE 1056-2001.....	216
ASSE 1009-90.....	215	ASSE Series 5000-98.....	216
ASSE 1023-79.....	215	AWWA C510-97.....	223
IAPMO PS 103-97.....	226	AWWA C511-97.....	223
IAPMO PS 108-98.....	226	IAPMO PS 23-89.....	224
IAPMO PS 113-99 <sup>e1</sup> .....	226	IAPMO PS 31-95.....	224
NFPA 85-2001.....	228	IAPMO PS 49-92.....	224
NSF 3-2001.....	228	IAPMO PS 65-2000.....	225
NSF 12-93.....	228		
NSF 18-96a.....	228	<b>Certification</b>	
NSF 29-93.....	228	ASME Section IX.....	214
NSF 42-2002.....	228	ASSE 6000-98.....	216
NSF 44-2002.....	228	AWS B2.2-91.....	222
NSF 53-2002.....	228	ISO Guide 65-1996.....	227
NSF 58-2002.....	228		
NSF 62-99.....	228	<b>DWV Components</b>	
UL 174-96.....	229	ANSI A112.21.2M-83.....	211
UL 399-93.....	229	ASME A112.21.1M-91(D).....	213
UL 430-94.....	229	ASME A112.36.2M-91(R98).....	214
UL 499-97.....	229	IAPMO PS 1-2000a.....	223
UL 563-95.....	229	IAPMO PS 7-84.....	224
UL 726-95.....	229	IAPMO PS 9-84.....	224
UL 732-95.....	229	IAPMO PS 38-99.....	224
UL 749-97.....	229	IAPMO PS 41-99.....	224
UL 834-95.....	229	IAPMO PS 47-2002.....	224
UL 921-96.....	229	IAPMO PS 52-99 <sup>e1</sup> .....	224
UL 1453-95.....	229	IAPMO PS 59-92.....	225
WQA S-300-91.....	229	IAPMO PS 60-96.....	225
		IAPMO PS 63-99a.....	225
		IAPMO PS 76-95.....	225

**DWV Components (cont.)**

IAPMO PS 79-95 .....	225
IAPMO PS 80-95 <sup>e1</sup> .....	225
IAPMO PS 81-2000 .....	225
IAPMO PS 86-95 .....	225
IAPMO PS 90-95 .....	226
IAPMO PS 100-96 .....	226
IAPMO PS 102-97 .....	226
IAPMO PS 105-97 .....	226
IAPMO PS 118-2000 .....	227
NSF 40-2000 .....	228
NSF 41-99 .....	228
NSF 46-2000 .....	228
PDI G-101-85 .....	228

**Fittings**

IAPMO PS 110-99 .....	226
IAPMO PS 111-99 .....	226
IAPMO PS 117-2001 .....	226

**Fixtures**

ANSI A112.19.5-99 .....	211
ANSI A118.10-93 .....	211
ANSI Z124.1-95 .....	212
ANSI Z124.2-95 .....	212
ANSI Z124.3-95 .....	212
ANSI Z124.4-96 .....	212
ANSI Z124.5-97 .....	212
ANSI Z124.6-97 .....	212
ANSI Z124.7-97 .....	212
ANSI Z124.8-90 .....	212
ANSI Z124.9-94 .....	212
ASME 112.1.3-2000 .....	212
ASME A112.3.4-2000 .....	213
ASME A112.6.1M-97 .....	213
ASME A112.6.2-2000 .....	213
ASME A112.14.3-2001 .....	213
ASME A112.14.4-2001 .....	213
ASME A112.19.1M-94(R99) .....	213
ASME A112.19.2M-98 .....	213
ASME A112.19.3M-2000 .....	213
ASME A112.19.4M-94(R99) .....	213
ASME A112.19.5-99 .....	213
ASME A112.19.6-95 .....	213
ASME A112.19.7M-95 .....	213
ASME A112.19.9M-91(R98) .....	213
ASME A112.19.12-2000 .....	213
ASSE 1014-90 .....	215
ASTM D 4068-2001 .....	220
ASTM D 4551-96(R01) .....	220

**Fixtures (cont.)**

ASTM D 6104-97 .....	220
FS WW-P-541-E-Gen.1980 .....	223
IAPMO PS 4-2000 <sup>e1</sup> .....	223
IAPMO PS 16-2000 .....	223
IAPMO PS 43-91 .....	223
IAPMO PS 50-92 .....	224
IAPMO PS 55-92 .....	224
IAPMO PS 58-92 .....	224
IAPMO PS 61-92 .....	225
IAPMO PS 62-93(D) .....	225
IAPMO PS 67-93 .....	225
IAPMO PS 70-2001 .....	225
IAPMO PS 71-2000(D) .....	225
IAPMO PS 77-99(D) .....	225
IAPMO PS 78-01 .....	225
IAPMO PS 83-95(D) .....	225
IAPMO PS 84-95(D) .....	225
IAPMO PS 89-95 .....	226
IAPMO PS 93-2000 .....	226
IAPMO PS 98-96 .....	226
IAPMO PS 99-96 .....	226
IAPMO PS 106-98 .....	226
MIL-V-29193-80(D) .....	227

**Fuel Gas**

ANSI B16.40-85(R94) .....	211
ANSI Z21.80-1997 • CSA 6.22-M97 .....	212
ANSI Z21.81-1997 • CSA 6.25-M97 .....	212
ANSI Z223.1-99 .....	212
IAPMO PS 40-2001 .....	224
IAS LC 1-99 • CSA 6.26-M99 .....	227
NFPA 54-2002 .....	228
NFPA 58-2001 .....	228
UL 569-95 .....	229

**Joints**

ANSI B2.1-90 .....	211
ANSI Z21.41-98 • CSA 6.9-M98 .....	212
ASME B1.20.1-83 (R92) .....	214
ASME B1.20.3-76 (R82/91/98) .....	214
ASME B16.5-96 .....	214
ASME B16.21-92 .....	214
ASTM B 29-92(R97) .....	216
ASTM B 32-96 .....	216
ASTM B 813-00 <sup>e1</sup> .....	217
ASTM B 828-00 .....	217

<b>Joints (cont.)</b>	
ASTM C 425-2002 .....	217
ASTM C 443-2001 .....	217
ASTM C 564-97 .....	217
ASTM C 1173-97 .....	217
ASTM D 1869-95(R00).....	218
ASTM D 2235-2001 .....	218
ASTM D 2564-96a .....	219
ASTM D 2657-97 .....	219
ASTM D 2672-96a .....	219
ASTM D 2855-96 .....	219
ASTM D 3122-95 .....	219
ASTM D 3138.95 .....	219
ASTM D 3139-98 .....	219
ASTM D 3140-90(D) .....	220
ASTM D 3212-96a .....	220
ASTM F 402-98(R99).....	220
ASTM F 493-97 .....	221
ASTM F 656-96a .....	221
AWS A5.8-92 .....	223
AWWA C606-97.....	223
CISPI HSN-85(D) .....	223
CISPI 310-97.....	223
FS A-A-51145C.....	223
FS O-F-499D-85 .....	223
FS O-F-506C-72(D) .....	223
FS TT-S-1732-71(D).....	223
IAPMO PS 25-84 .....	224
IAPMO PS 36-90 .....	224
IAPMO PS 51-98 .....	224
IAPMO PS 53-92 .....	224
MSS SP-73-91.....	227
SAE J1670-93.....	228
<b>Kitchen, Lavatory, and Shower Fittings with Attached Hose Outlets</b>	
ASME A112.18.3-96 .....	213
<b>Miscellaneous</b>	
ANSI / ICC A117.1-98 .....	211
ANSI Z358.1-98 .....	212
ASHRAE 90.1-2001 .....	212
ASTM B 152-2000.....	216
ASTM B 370-98.....	217
ASTM C 478-97 .....	217
ASTM D 396-2001 .....	218
ASTM D 4101-2002 .....	220
ASTM E 84-2001 .....	220
ASTM E 119-2000a.....	220
ASTM E 814-2000.....	220
FS OO-L-201 f-70.....	223
FS QQ-R-571C-69(D).....	223
<b>Miscellaneous (cont.)</b>	
IAPMO PS 48-2000 .....	224
IAPMO PS 54-2001a .....	224
IAPMO PS 73-93 .....	225
IAPMO PS 88-95 .....	226
IAPMO PS 92-95 .....	226
IAPMO PS 94-2001a .....	226
IAPMO PS 96-96 .....	226
IAPMO PS 114-99 <sup>e1</sup> .....	226
IAPMO PS 115-99 .....	226
IAPMO PS 116-99 .....	226
IAPMO PS 119-2000 .....	227
MIL-P-22561-82(D) .....	227
NFPA 13R-99.....	228
NFPA 13D-99 .....	228
NFPA 31-2001.....	228
NFPA 211-2000.....	228
NSF 24-96.....	228
NSF 61-01.....	228
SAMA LF6a .....	228
UL 80-96 .....	228
UL 103-95 .....	228
UL 378-93 .....	229
UL 441-96 .....	229
UL 443-95 .....	229
UL 723-96 .....	229
3-GP-28.....	229
<b>Piping</b>	
ANSI A13.1-81(R93) .....	211
ASME A112.1.2-96 .....	212
ASME A112.4.3-99 .....	213
ASME A112.18.6-99 .....	213
ASME A112.26.1M-84(D).....	213
ASSE 1010-98.....	215
ASSE 1034-81(D).....	215
AWWA C203-91a.....	222
FS WW-P 325B-76 .....	223
IAPMO PS 14-99 .....	224
IAPMO PS 34-96 .....	224
IAPMO PS 37-90 .....	224
IAPMO PS 42-96 .....	224
IAPMO PS 64-98 .....	225
IAPMO PS 66-2000 .....	225
IAPMO PS 85-95 .....	225
IAPMO PS 95-2001 .....	226
MSS SP-25-98.....	227

MSS SP-58-93.....	227	ASTM A 47-99.....	216
NFPA 99-2002.....	228	ASTM A 53-2001.....	216
NFPA 99C-2002.....	228	ASTM A 74-98.....	216
PDI-WH 201-92.....	228	ASTM A 126-95(R01).....	216
<b>Piping, Copper Alloy</b>		<b>Piping, Ferrous (cont.)</b>	
ASME B16.15-85 (R94).....	214	ASTM A 197M-2000.....	216
ASME B16.18-84.....	214	ASTM A 312-2001a.....	216
ASME B16.22-95.....	214	ASTM A 377-99.....	216
ASME B16.23-92.....	214	ASTM A 518-99.....	216
ASME B16.24-2002.....	214	ASTM A 536-84(R99 <sup>e1</sup> ).....	216
ASME B16.26-88.....	214	ASTM A 653M-2001a.....	216
ASME B16.29-2002.....	214	ASTM A 733-2001.....	216
ASME B16.32-92.....	214	ASTM A 861-2001a.....	216
ASTM B 42-98.....	216	ASTM A 888-98 <sup>e1</sup> .....	216
ASTM B 43-98.....	216	ASTM C 1277-97.....	217
ASTM B 75-99.....	216	AWWA C110-98.....	222
ASTM B 88-99 <sup>e1</sup> .....	216	AWWA C111-2000.....	222
ASTM B 135-2000.....	216	AWWA C151-96.....	222
ASTM B 251-97.....	216	AWWA C153-2000.....	222
ASTM B 280-99 <sup>e1</sup> .....	217	AWWA C213-2001.....	222
ASTM B 302-2000.....	217	AWWA C215-99.....	222
ASTM B 306-99.....	217	CISPI 301-2000.....	223
ASTM B 4472000.....	217	IAPMO PS 97-2001.....	226
ASTM B 584-2000.....	217	MIL-F-18180C1.....	227
ASTM B 587-97 <sup>e1</sup> .....	217	MSS SP-42-99.....	227
ASTM B 641-93(D).....	217	MSS SP-44-96.....	227
ASTM B 642-88(D).....	217	MSS SP-83-2001.....	227
ASTM B 687-99.....	217		
ASTM B 716-93(D).....	217	<b>Piping, Non-Metallic</b>	
ASTM B 819-2000.....	217	ANSI A106.6-70.....	211
FS WW-U-516A-74(b).....	223	ASTM C 14-99.....	217
IAPMO PS 2-2000a.....	223	ASTM C 296-2000.....	217
MIL-F-1183 H-83(D).....	227	ASTM C 412-99.....	217
		ASTM C 428-97(R02).....	217
		ASTM C 700-2002.....	217
		ASTM C 1053-2000.....	217
		AWWA C400-93.....	222
<b>Piping, Ferrous</b>			
ANSI A21.10-98.....	211	<b>Piping, Plastic</b>	
ANSI A21.11-2000.....	211	ASTM C 1440-99 <sup>e1</sup> .....	218
ANSI A21.51-96.....	211	ASTM C 1460-2000.....	218
ANSI A21.53-2000.....	211	ASTM C 1461-2000.....	218
ANSI A40.3-93.....	211	ASTM D 1527-99.....	218
ASME A112.3.1-93.....	213	ASTM D 1785-99.....	218
ASME B16.1-89.....	214	ASTM D 2104-2001.....	218
ASME B16.3-99.....	214	ASTM D 2146-82(D).....	218
ASME B16.4-98.....	214	ASTM D 2239-2001.....	218
ASME B16.12-98.....	214	ASTM D 2241-2000.....	218
ASME B16.39-98.....	214		
ASME B16.47-96.....	214		
ASME B36.10M-2000.....	214		



ASTM D 2282-99 .....	218	ASTM F 891-2000 .....	221
ASTM D 2321-2000 .....	218	ASTM F 949-2001a .....	221
ASTM D 2447-2001 .....	218	ASTM F 1216-98 .....	221
ASTM D 2464-99 .....	218	ASTM F 1281-2001a .....	221
<b>Piping, Plastic (cont.)</b>		<b>Piping, Plastic (cont.)</b>	
ASTM D 2465-73(D) .....	218	ASTM F 1282-2001a .....	221
ASTM D 2466-2001 .....	218	ASTM F 1412-2001 .....	221
ASTM D 2467-2001 .....	218	ASTM F 1673-95 .....	221
ASTM D 2468-96a .....	218	ASTM F 1743-96 .....	221
ASTM D 2469-76(D) .....	218	ASTM F 1807-99 .....	221
ASTM D 2513-2001a .....	219	ASTM F 1866-98 .....	221
ASTM D 2517-2000 .....	219	ASTM F 1924-2001 .....	221
ASTM D 2609-2000 .....	219	ASTM F 1948-99a .....	221
ASTM D 2661-2001 .....	219	ASTM F 1960-2000 <sup>e1</sup> .....	222
ASTM D 2665-2001 .....	219	ASTM F 1961-99 .....	222
ASTM D 2680-2001 .....	219	ASTM F 1970-2001 .....	222
ASTM D 2729-96a .....	219	ASTM F 1973-99e1 .....	222
ASTM D 2737-2001 .....	219	ASTM F 2080-2001 .....	222
ASTM D 2740-89 <sup>e1</sup> (D) .....	219	AWWA C900-97 .....	223
ASTM D 2751-96a .....	219	AWWA C901-97 .....	223
ASTM D 2846-99 .....	219	AWWA C902-96 .....	223
ASTM D 2996-2001 .....	219	FS K65.59-71 .....	223
ASTM D 3033-85(D) .....	219	FS M265-811 .....	223
ASTM D 3034-2001 .....	219	IAPMO PS 69-2001 .....	225
ASTM D 3035-2001 .....	219	IAPMO PS 82-95 .....	225
ASTM D 3036-73(D) .....	219	IAPMO PS 91-95 .....	226
ASTM D 3298-81(D) .....	220	IAPMO PS 107-98 .....	226
ASTM D 3311-94 .....	220	NSF 14-2002 .....	228
ASTM D 3965-99 .....	220	<b>Pumps</b>	
ASTM F 405-98 .....	220	MIL-P-17552F .....	227
ASTM F 409-99a .....	220	MIL-P-21251E .....	227
ASTM F 437-99 .....	220	MIL-P-52407 (A)-1976(D) .....	227
ASTM F 438-2001 .....	220	MIL-P-62156 (1)-1983(D) .....	227
ASTM F 439-2001 .....	220	MIL-P-B-81(D) SSPMA-85 .....	227
ASTM F 441-99 .....	220	UL 343-97 .....	229
ASTM F 442-99 .....	220	UL 778-96 .....	229
ASTM F 443-77 <sup>e1</sup> (D) .....	220	<b>Swimming Pools and Spas</b>	
ASTM F 480-2000 .....	220	ANSI Z21.56-98 • CSA 4.7-2001 .....	212
ASTM F 628-2001 .....	221	ASME A112.19.8M-87(R96) .....	213
ASTM F 667-97 .....	221	NSPI 1-1991 .....	224
ASTM F 714-2001 .....	221	<b>Valves</b>	
ASTM F 789-95a .....	221	ANSI A112.14.1-75 (R90) .....	211
ASTM F 794-2001 .....	221	ANSI Z21.15-97 .....	212
ASTM F 810-2001 .....	221	ANSI Z21.22-99 .....	212
ASTM F 876-2001 <sup>e1</sup> .....	221	ANSI Z21.70-81(D) .....	212
ASTM F 877-2001 <sup>e1</sup> .....	221		

**Valves (cont.)**

ASME A112.18.1M-2000 .....213  
 ASME A112.18.7-99 .....213  
 ASME A112.21.3M-85 (R01) .....213  
 ASME B16.33-90 .....214  
 ASME B16.34-96 .....214  
 ASME B16.38-85 .....214  
 ASSE 1003-2001 .....214  
 ASSE 1016-96 .....215  
 ASSE 1017-98 .....215  
 ASSE 1018-2001 .....215  
 ASSE 1025-78 .....215  
 ASSE 1028-81(D) .....215  
 ASSE 1062-97 .....216  
 ASSE 1066-97 .....216  
 AWWA C500-93 .....222  
 AWWA C504-2000 .....222  
 AWWA C507-99 .....222  
 CSA 3-92 .....223  
 FS WW-V-54d(D) .....223  
 FS WW-V-58b .....223  
 IAPMO PS 45-91 .....224  
 IAPMO PS 57-92 .....224  
 IAPMO PS 72-2000 .....225  
 IAPMO PS 87-95 .....225  
 IAPMO PS 101-97 .....226  
 IAPMO PS 104-97 .....226  
 IAPMO PS 112-99 .....226  
 MSS SP-67-95 .....227  
 MSS SP-70-98 .....227  
 MSS SP-71-97 .....227  
 MSS SP-72-99 .....227  
 MSS SP-78-97 .....227  
 MSS SP-80-97 .....227  
 MSS SP-84(D) .....227  
 UL 125-97 .....229  
 UL 132-97 .....229  
 UL 144-99 .....229  
 UL 352-97 .....229

**ABBREVIATIONS IN TABLE 14-1**

<b>AHAM</b>	Association of Home Appliance Manufacturers, 1111 19th Street, N.W., Suite 402, Washington DC 20036.
<b>ANSI</b>	American National Standards Institute, Inc., 25 W. 42nd Street, 4th floor, New York, NY 10036.
<b>ASME</b>	The American Society of Mechanical Engineering, Three Park Avenue, New York, NY 10016.
<b>ASSE</b>	American Society of Sanitary Engineering, 901 Canterbury, Suite A, Westlake, Ohio 44145.
<b>ASTM</b>	American Society of Testing and Materials, 100 Barr Harbor Drive, West Conshohocken, PA 19428-2959.
<b>AWS</b>	American Welding Society, 550 NW LeJuene Road, Miami, FL 33126.
<b>AWWA</b>	American Water Works Association, 6666 W. Quincy Avenue, Denver, CO 80235.
<b>CISPI</b>	Cast Iron Soil Pipe Institute, 5959 Shallowford Road, Suite 419, Chattanooga, TN 37421.
<b>(D) or [D]</b>	Discontinued.
<b>e1</b>	An editorial change since the last revision or reapproval.
<b>FS</b>	Federal Specifications, Federal Supply Service, Standards Division, General Services Administration, 7th and D Streets, Washington, DC 20407.
<b>IAPMO</b>	International Association of Plumbing and Mechanical Officials, 5001 E. Philadelphia Street, Ontario, CA 91761.
<b>ICC</b>	International Code Council, 5203 Leesburg Pike, Suite 600, Falls Church, VA 22041.
<b>MSS</b>	Manufacturers Standardization Society of the Valve and Fittings Industry, 127 Park Street, N.E., Vienna, VA 22180.
<b>NFPA</b>	National Fire Protection Association, P.O. Box 9101, 1 Batterymarch Park, Quincy, MA 02269-9101.
<b>NSF</b>	NSF International, 789 Dixboro Road, Ann Arbor, MI 48113-0140
<b>PDI</b>	Plumbing and Drainage Institute, 800 Turnpike Street, Suite 300, North Andover, MA 01845.
<b>UL</b>	Underwriters' Laboratories, Inc., 333 Pfingsten Road, Northbrook, IL 60062.
<b>WQA</b>	Water Quality Association, 4151 Naperville Road, Lisle, IL 60532-1088.

# CHAPTER 15

## FIRESTOP PROTECTION

### 1501.0 General Requirements.

**1501.1 Applicability.** All piping penetrations of required fire-resistance-rated walls, partitions, floors, floor/ceiling assemblies, roof/ceiling assemblies, or shaft enclosures shall be protected in accordance with the requirements of NFPA 5000, *NFPA Building Code*, and this chapter. The penetration must meet any additional requirements for protection of the penetration in the building code adopted by the Authority Having Jurisdiction.

### 1502.0 Plans and Specifications.

**1502.1** Plans and specifications shall indicate with sufficient detail how penetrations of fire-resistance-rated assemblies shall be firestopped prior to obtaining design approval by the Authority Having Jurisdiction.

### 1503.0 Installation.

**1503.1** Firestop materials shall be installed in accordance with this chapter, the Building Code, and the manufacturer's instructions.

### 1504.0 Definitions.

**1504.1 Penetration Firestop System.** A specific assemblage of field-assembled materials, or a factory-made device, which has been tested to a standard test method and, when installed properly on penetrating piping materials, is capable of maintaining the fire resistance rating of assemblies penetrated.

**1504.2 F Rating.** The time period that the penetration firestop system limits the spread of fire through the penetration when tested in accordance with ASTM E 814.

**1504.3 T Rating.** The time period that the penetration firestop system, including the penetrating item, limits the maximum temperature rise of 325°F above its initial temperature through the penetration on the nonfire side, when tested in accordance with ASTM E 814.

### 1505.0 Combustible Installations.

**1505.1** Combustible piping installations shall be protected in accordance with the appropriate fire resistance rating requirements in the building code that list the acceptable area, height, and type of construction for use in specific occupancies to assure

compliance and integrity of the fire resistance rating prescribed.

**1505.2** When penetrating a fire-resistance-rated wall, partition, floor, floor-ceiling assembly, roof-ceiling assembly, or shaft enclosure, the fire resistance rating of the assembly shall be restored to its original rating with a material or product tested to standard(s) referenced in Chapter 14 and at an independent testing agency acceptable to the Authority Having Jurisdiction.

**1505.3** Penetrations shall be protected by an approved penetration firestop system installed as tested in accordance with ASTM E 119 or ASTM E 814, with a minimum positive pressure differential of 0.01 inch of water. Systems shall have an F rating of at least 1 hour but not less than the required fire resistance rating of the assembly being penetrated. Systems protecting floor penetrations shall have a T rating of at least 1 hour but not less than the required fire resistance rating of the floor being penetrated. Floor penetrations contained within the cavity of a wall at the location of the floor penetration do not require a T rating. No T rating shall be required for floor penetrations by piping that is not in direct contact with combustible material.

**1505.4** When piping penetrates a rated assembly, combustible piping shall not connect to non-combustible piping unless it can be demonstrated that the transition complies with the requirements of Section 1505.3.

**1505.5 Insulation and Coverings.** Insulation and coverings on or in the penetrating item shall not be permitted unless the specific insulating or covering material has been tested as part of the penetrating firestop system.

**1505.6 Sleeves.** Where sleeves are used, the sleeves should be securely fastened to the fire-resistance-rated assembly. The (inside) annular space between the sleeve and the penetrating item and the (outside) annular space between the sleeve and the fire-resistance-rated assembly shall be firestopped in accordance with the requirements for a sleeve penetrating item.

### 1506.0 Non-combustible Piping Installations.

**1506.1** Non-combustible piping installations shall be protected in accordance with the appropriate fire resistance rating requirements in the building code that list the acceptable area, height, and type of construction for use in specific occupancies to assure

compliance and integrity of the fire resistance rating prescribed.

**1506.2** When penetrating a fire-resistance-rated wall, partition, floor, floor-ceiling assembly, roof-ceiling assembly, or shaft enclosure, the fire resistance rating of the assembly shall be restored to its original rating with a material or product tested to standard(s) referenced in Section 1506.3 and at an independent testing agency acceptable to the Authority Having Jurisdiction.

**Exceptions:**

- (1) Concrete, mortar, or grout may be used to fill the annular spaces around cast iron, copper, or steel piping that penetrates concrete or masonry fire-resistant-rated assemblies. The nominal diameter of the penetrating item should not exceed 6 inches (15.2 cm), and the opening size should not exceed 144 in.<sup>2</sup> (929 cm<sup>2</sup>).

The thickness of concrete, mortar, or grout should be the full thickness of the assembly or the thickness necessary to provide a fire resistance rating not less than the required fire resistance rating of the assembly penetrated, or

- (2) The material used to fill the annular space shall prevent the passage of flame and hot gases sufficient to ignite cotton waste for the time period equivalent to the fire-resistance rating of the assembly when tested to standard(s) referenced in Section 1506.3.

**1506.3** Penetrations shall be protected by an approved penetration firestop system installed as tested in accordance with ASTM E 119 or ASTM E 814, with a minimum positive pressure differential of 0.01 inch of water. Systems shall have an F rating of at least 1 hour but not less than the required fire-resistance rating of the assembly being penetrated. Systems protecting floor penetrations shall have a T rating of at least 1 hour but not less than the required fire-resistance rating of the floor being penetrated. Floor penetrations contained within the cavity of a wall at the location of the floor penetration do not require a T rating. No T rating shall be required for floor penetrations by piping that is not in direct contact with combustible material.

**1506.4** When piping penetrates a rated assembly, combustible piping shall not connect to non-combustible piping unless it can be demonstrated that the transition complies with the requirements of Section 1506.3.

**1506.5** Unshielded couplings shall not be used to connect non-combustible piping unless it can be

demonstrated that the fire-resistive integrity of the penetration is maintained.

**1506.6 Sleeves.** Where sleeves are used, the sleeves should be securely fastened to the fire-resistance-rated assembly. The (inside) annular space between the sleeve and the penetrating item and the (outside) annular space between the sleeve and the fire-resistance-rated assembly shall be firestopped in accordance with the requirements for a sleeve-penetrating item.

**1506.7 Insulation and Coverings.** Insulation and coverings on or in the penetrating item shall not be permitted unless the specific insulating or covering material has been tested as part of the penetrating firestop system.

**1507.0 Required Inspection.**

**1507.1 General.** Prior to being concealed, piping penetrations shall be inspected by the Authority Having Jurisdiction to verify compliance with the fire-resistance rating prescribed in the Building Code, NFPA 5000, NFPA Building Code.

**1507.2** The Authority Having Jurisdiction shall conduct a thorough examination of sufficient representative installations, including destructive inspection, to provide verification of satisfactory compliance with this chapter, the appropriate manufacturers' installation standards applied by the installer, construction documents, specifications, and applicable manufacturers' product information.

**1507.3** The Authority Having Jurisdiction shall determine the type, size, and quantity of penetrations to be inspected.

**1507.4** The Authority Having Jurisdiction shall compare the field installations with the documentation supplied by the installer to determine the following:

- (1) The required F ratings (1, 2, 3, or 4 hour) and T ratings (0, 1, 2, 3, or 4 hour) of the firestop penetration firestop systems are suitable for the assembly being penetrated.
- (2) The penetrating firestop systems are appropriate for the penetrating items as documented through testing of the systems conducted by an independent testing agency.
- (3) The penetrating firestop system is installed as tested.

# APPENDICES

The appendices are intended to supplement the provisions of the installation requirements of this Code. The definitions in Chapter 2 are also applicable to the appendices.

## CONTENTS

	Page
Appendix A	
Recommended Rules for Sizing the Water Supply System .....	241
Appendix B	
Explanatory Notes on Combination Waste and Vent Systems .....	257
Appendix C Deleted	
Appendix D	
Sizing Storm Water Drainage Systems .....	259
Appendix E	
Manufactured/Mobile Home Parks and Recreational Vehicle Parks .....	267
Appendix F	
<i>Reserved</i>	
Appendix G	
Gray Water Systems for Single-Family Dwellings .....	279
Appendix H	
Recommended Procedures for Design, Construction, and Installation of Commercial Kitchen Grease Interceptors .....	289
Appendix I	
Installation Standards .....	293
Appendix J	
Reclaimed Water Systems for Non-Residential Buildings .....	397
Appendix K	
Private Sewage Disposal Systems .....	401
Appendix L	
Alternate Plumbing Systems .....	413



# APPENDIX A

## RECOMMENDED RULES FOR SIZING THE WATER SUPPLY SYSTEM

Because of the variable conditions encountered, it is impractical to lay down definite detailed rules of procedure for determining the sizes of water supply pipes in an appendix which must necessarily be limited in length. For a more adequate understanding of the problems involved, refer to Water-Distributing Systems for Buildings, Report BMS 79 of the National Bureau of Standards; and Plumbing Manual, Report BMS 66, also published by the National Bureau of Standards.

The following is a suggested order of procedure for sizing the water supply system.

### A 1 Preliminary Information.

**A 1.1** Obtain the necessary information regarding the minimum daily service pressure in the area where the building is to be located.

**A 1.2** If the building supply is to be metered, obtain information regarding friction loss relative to the rate of flow for meters in the range of sizes likely to be used. Friction-loss data can be obtained from most manufacturers of water meters. Friction losses for disk-type meters may be obtained from Chart A-1.

**A 1.3** Obtain all available local information regarding the use of different kinds of pipe with respect both to durability and to decrease in capacity with length of service in the particular water supply.

### A 2 Demand Load.

**A 2.1** Estimate the supply demand for the building main and the principal branches and risers of the system by totaling the fixture units on each, Table A-2, and then by reading the corresponding ordinate from Chart A-2 or A-3, whichever is applicable.

**A 2.2** Estimate continuous supply demands in gallons per minute (liters per second) for lawn sprinklers, air conditioners, etc., and add the sum to the total demand for fixtures. The result is the estimated supply demand of the building supply.

### A 3 Permissible Friction Loss.

**A 3.1** Decide what is the desirable minimum residual pressure that shall be maintained at the highest fixture in the supply system. If the highest group of fixtures contains flushometer valves, the residual pressure for the group shall not be less than fifteen (15) psi (103 kPa). For flush tank supplies, the

available residual pressure shall not be less than eight (8) psi (55 kPa).

**A 3.2** Determine the elevation of the highest fixture or group of fixtures above the water (street) main. Multiply this difference in elevation by forty-three hundredths (0.43). The result is the loss in static pressure in psi (pounds per square inch) (kPa).

**A 3.3** Subtract the sum of loss in static pressure and the residual pressure to be maintained at the highest fixture from the average minimum daily service pressure. The result will be the pressure available for friction loss in the supply pipes, if no water meter is used. If a meter is to be installed, the friction loss in the meter for the estimated maximum demand should also be subtracted from the service pressure to determine the pressure loss available for friction loss in the supply pipes.

**A 3.4** Determine the developed length of pipe from the water (street) main to the highest fixture. If close estimates are desired, compute with the aid of Table A-3 the equivalent length of pipe for all fittings in the line from the water (street) main to the highest fixture and add the sum to the developed length. The pressure available for friction loss in pounds per square inch (kPa), divided by the developed lengths of pipe from the water (street) main to the highest fixture, times one hundred (100), will be the average permissible friction loss per one hundred (100) foot (30,480 mm) length of pipe.

### A 4 Size of Building Supply.

**A 4.1** Knowing the permissible friction loss per one hundred (100) feet (30,480 mm) of pipe and the total demand, the diameter of the building supply pipe may be obtained from Charts A-4, A-5, A-6, or A-7, whichever is applicable. The diameter of pipe on or next above the coordinate point corresponding to the estimated total demand and the permissible friction loss will be the size needed up to the first branch from the building supply pipe.

**A 4.2** If copper tubing or brass pipe is to be used for the supply piping and if the character of the water is such that only slight changes in the hydraulic characteristics may be expected, Chart A-4 may be used.

**A 4.3** Chart A-5 should be used for ferrous pipe with only the most favorable water supply as regards corrosion and caking. If the water is hard or corrosive, Chart A-6 or A-7 will be applicable. For extremely hard water, it will be advisable to make



additional allowances for the reduction of capacity of hot-water lines in service.

### A 5 Size of Principal Branches and Risers.

**A 5.1** The required size of branches and risers may be obtained in the same manner as the building supply by obtaining the demand load on each branch or riser and using the permissible friction loss computed in Section A 3.

**A 5.2** Fixture branches to the building supply, if they are sized for the same permissible friction loss per one hundred (100) feet (30,480 mm) of pipe as the branches and risers to the highest level in the building, may lead to inadequate water supply to the upper floor of a building. This may be controlled by (1) selecting the sizes of pipe for the different branches so that the total friction loss in each lower branch is approximately equal to the total loss in the riser, including both friction loss and loss in static pressure; (2) throttling each such branch by means of a valve until the preceding balance is obtained; (3) increasing the size of the building supply and risers above the minimum required to meet the maximum permissible friction loss.

**A 5.3** The size of branches and mains serving flushometer tanks shall be consistent with sizing procedures for flush tank water closets.

### A 6 General.

**A 6.1** Velocities shall not exceed 10 feet/second (3.0 m/sec.) or the maximum values given in the appropriate Installation Standard, except as otherwise approved by the Authority Having Jurisdiction.

**A 6.2** If a pressure-reducing valve is used in the building supply, the developed length of supply piping and the permissible friction loss should be computed from the building side of the valve.

**A 6.3** The allowances in Table A-3 for fittings are based on non-recessed threaded fittings. For recessed threaded fittings and streamlined soldered fittings, one-half (1/2) the allowances given in the table will be ample.

### A 7 Example.

**A 7.1** Assume an office building of four (4) stories and basement; pressure on the building side of the pressure-reducing valve of fifty-five (55) psi (379 kPa) (after an allowance for reduced pressure falloff at peak demand); an elevation of highest fixture above the pressure-reducing valve of forty-five (45) feet (13,716 mm); a developed length of

pipe from the pressure-reducing valve to the most distant fixture of two hundred (200) feet (60,960 mm); and fixtures to be installed with flush valves for water closets and stall urinals as follows:

If the pipe material and water supply are such that Chart A-5 applies, the required diameter of the building supply is three (3-1/2) inches (88.9 mm) and the required diameter of the branch to the hot-water heater is one and one-half (1-1/2) inches (40 mm).

The sizes of the various branches and risers may be determined in the same manner as the size of the building supply or the branch to the hot-water system by estimating the demand for the riser or branch from Chart A-2 or A-3 and applying the total demand estimate from the branch, riser, or section thereof to the appropriate flowchart.

**Chart A-1**  
**Friction Losses for Disk-Type Water Meters**

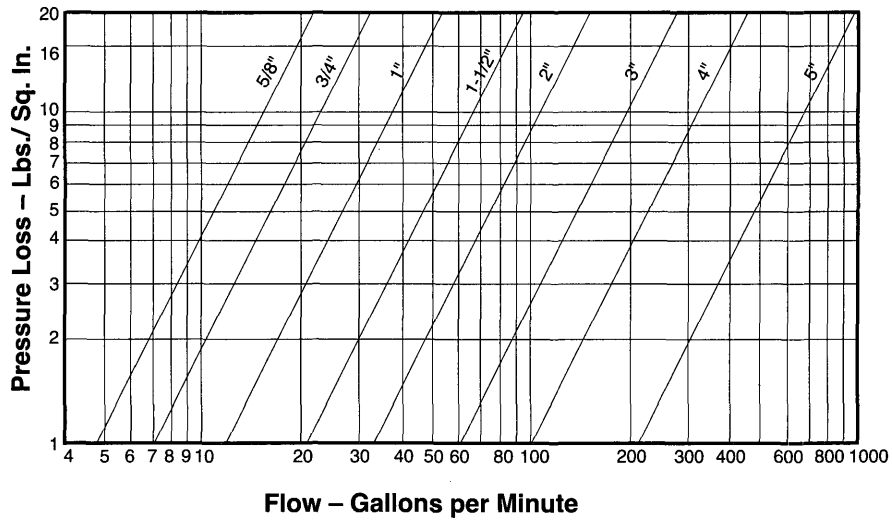

**Chart A-1 (Metric)**  
**Friction Losses for Disk-Type Water Meters**

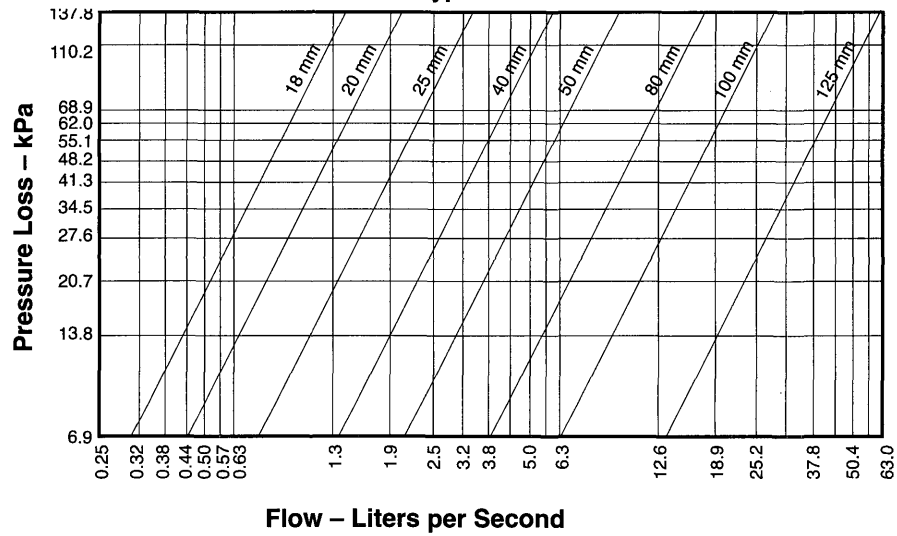

Inch	mm
1/2	15
3/4	20
1	25

**TABLE A-2**  
**Water Supply Fixture Units (WSFU) and Minimum Fixture Branch Pipe Sizes<sup>3</sup>**

	Minimum Fixture Branch Pipe Size <sup>1,4</sup>	Private	Public	Assembly <sup>6</sup>
<b>Appliances, Appurtenances or Fixtures<sup>2</sup></b>				
Bathtub or Combination Bath/Shower (fill) .....	1/2"	4.0	4.0	
3/4" Bathtub Fill Valve .....	3/4"	10.0	10.0	
Bidet .....	1/2"	1.0		
Clothes Washer .....	1/2"	4.0	4.0	
Dental Unit, cuspidor .....	1/2"		1.0	
Dishwasher, domestic .....	1/2"	1.5	1.5	
Drinking Fountain or Watercooler .....	1/2"	0.5	0.5	0.75
Hose Bibb .....	1/2"	2.5	2.5	
Hose Bibb, each additional <sup>7</sup> .....	1/2"	1.0	1.0	
Lavatory .....	1/2"	1.0	1.0	1.0
Lawn Sprinkler, each head <sup>5</sup> .....		1.0	1.0	
Mobile Home, each (minimum) .....		12.0		
<b>Sinks</b>				
Bar .....	1/2"	1.0	2.0	
Clinic Faucet .....	1/2"		3.0	
Clinic Flushometer Valve .....				
with or without faucet .....	1"		8.0	
Kitchen, domestic .....	1/2"	1.5	1.5	
Laundry .....	1/2"	1.5	1.5	
Service or Mop Basin .....	1/2"	1.5	3.0	
Washup, each set of faucets .....	1/2"		2.0	
Shower .....	1/2"	2.0	2.0	
Urinal, 1.0 GPF .....	3/4"	3.0	4.0	5.0
Urinal, greater than 1.0 GPF .....	3/4"	4.0	5.0	6.0
Urinal, flush tank .....	1/2"	2.0	2.0	3.0
Washfountain, circular spray .....	3/4"		4.0	
Water Closet, 1.6 GPF Gravity Tank .....	1/2"	2.5	2.5	3.5
Water Closet, 1.6 GPF Flushometer Tank .....	1/2"	2.5	2.5	3.5
Water Closet, 1.6 GPF Flushometer Valve .....	1"	5.0	5.0	8.0
Water Closet, greater than 1.6 GPF Gravity Tank .....	1/2"	3.0	5.5	7.0
Water Closet, greater than 1.6 GPF Flushometer Valve .....	1"	7.0	8.0	10.0

**Notes:**

1. Size of the cold branch outlet pipe, or both the hot and cold branch outlet pipes.
2. Appliances, Appurtenances, or Fixtures not included in this Table may be sized by reference to fixtures having a similar flow rate and frequency of use.
3. The listed fixture unit values represent their total load on the cold water service. The separate cold water and hot water fixture unit value for fixtures having both cold and hot water connections may each be taken as three-quarters (3/4) of the listed total value of the fixture.
4. The listed minimum supply branch pipe sizes for individual fixtures are the nominal (I.D.) pipe size.
5. For fixtures or supply connections likely to impose continuous flow demands, determine the required flow in gallons per minute (GPM) and add it separately to the demand (in GPM) for the distribution system or portions thereof.
6. Assembly [Public Use (See Table 4-1)].
7. Reduced fixture unit loading for additional hose bibbs as used is to be used only when sizing total building demand and for pipe sizing when more than one hose bibb is supplied by a segment of water distributing pipe. The fixture branch to each hose bibb shall be sized on the basis of 2.5 fixture units.

**TABLE A-3**  
**Allowance in Equivalent Length of Pipe for Friction Loss in Valves and Threaded Fittings\***  
**Equivalent Length of Pipe for Various Fittings**

Diameter of Fitting Inches	90° Standard Elbow Feet	45° Standard Elbow Feet	90° Standard Tee Feet	Coupling or Straight Run of Tee Feet	Gate Valve Feet	Globe Valve Feet	Angle Valve Feet
3/8	1.0	0.6	1.5	0.3	0.2	8	4
1/2	2.0	1.2	3.0	0.6	0.4	15	8
3/4	2.5	1.5	4.0	0.8	0.5	20	12
1	3.0	1.8	5.0	0.9	0.6	25	15
1-1/4	4.0	2.4	6.0	1.2	0.8	35	18
1-1/2	5.0	3.0	7.0	1.5	1.0	45	22
2	7.0	4.0	10.0	2.0	1.3	55	28
2-1/2	8.0	5.0	12.0	2.5	1.6	65	34
3	10.0	6.0	15.0	3.0	2.0	80	40
4	14.0	8.0	21.0	4.0	2.7	125	55
5	17.0	10.0	25.0	5.0	3.3	140	70
6	20.0	12.0	30.0	6.0	4.0	165	80

**TABLE A-3 (Metric)**  
**Equivalent Length of Pipe for Various Fittings**

Diameter of Fitting mm	90° Standard Elbow mm	45° Standard Elbow mm	90° Standard Tee mm	Coupling or Straight Run of Tee mm	Gate Valve mm	Globe Valve mm	Angle Valve mm
10	305	183	457	91	61	2,438	1,219
15	610	366	914	183	122	4,572	2,438
20	762	457	1,219	244	152	6,096	3,658
25	914	549	1,524	274	183	7,620	4,572
32	1,219	732	1,829	366	244	10,668	5,486
40	1,524	914	2,134	457	305	13,716	6,706
50	2,134	1,219	3,048	610	396	16,764	8,534
65	2,438	1,524	3,658	762	488	19,812	10,363
80	3,048	1,829	4,572	914	610	24,384	12,192
100	4,267	2,438	6,401	1,219	823	38,100	16,764
125	5,182	3,048	7,620	1,524	1,006	42,672	21,336
150	6,096	3,658	9,144	1,829	1,219	50,292	24,384

\*Allowances are based on non-recessed threaded fittings. Use one-half (1/2) the allowances for recessed threaded fittings or streamlined solder fittings.

**A 7 Example**

**Fixture Units and Estimated Demands**

Kind of Fixtures	Building Supply Demand				Branch to Hot Water System Demand		
	No. of Fixtures	Fixture Unit Demand	Total Units	Building Supply Demand in gpm (L per sec)	No. of Fixtures	Fixture Unit in gallons Demand per minute Calculation	Demand (L per sec)
Water Closets	130	8.0	1040	-	-	-	-
Urinals	30	4.0	120	-	-	-	-
Shower Heads	12	2.0	24	-	12	$12 \times 2 \times 3/4 = 18$	-
Lavatories	100	1.0	100	-	100	$100 \times 1 \times 3/4 = 75$	-
Service Sinks	27	3.0	81	-	27	$27 \times 3 \times 3/4 = 61$	-
<b>Total</b>				1,365,252 gpm (15.8 L/s)		154	55 gpm (3.4 L/s)

Allowing for 15 psi (103.4 kPa) at the highest fixture under the maximum demand of 252 gallons per minute (15.8 L/sec.), the pressure available for friction loss is found by the following:

$$55 - [15 + (45 \times 0.43)] = 20.65 \text{ psi}$$

$$\text{Metric: } 379 - [103.4 + (13.7 \times 9.8)] = 142.3 \text{ kPa}$$

The allowable friction loss per 100 feet (30.4 m) of pipe is therefore:

$$100 \times 20.65 \div 200 = 10.32 \text{ psi}$$

$$\text{Metric: } 30.4 \times 142.3 \div 60.8 = 71.1 \text{ kPa}$$

**Chart A-2**  
**Estimate Curves for Demand Load**

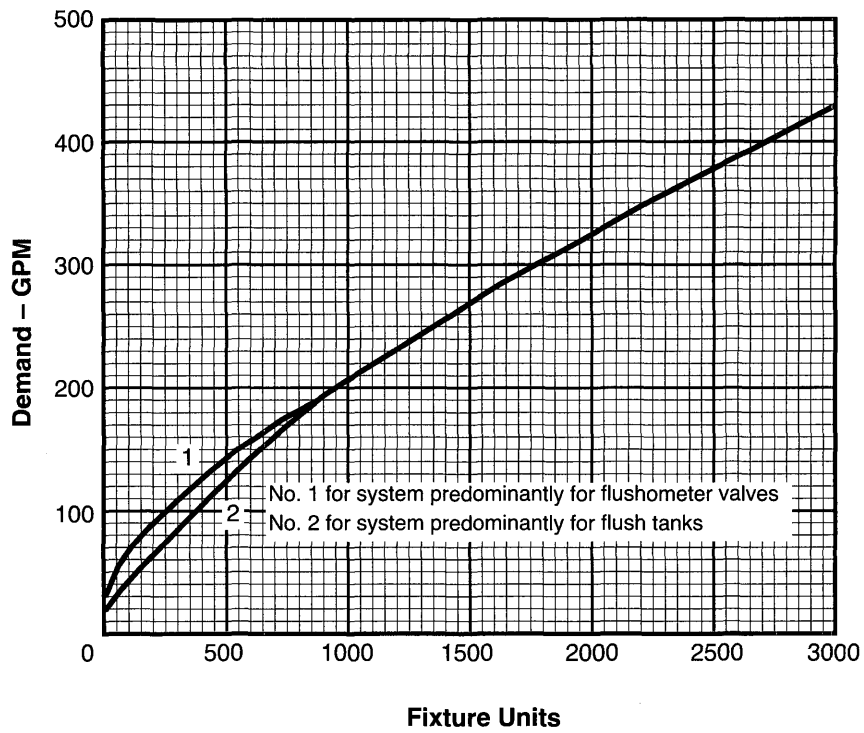

**Chart A-2 (Metric)**  
**Estimate Curves for Demand Load**

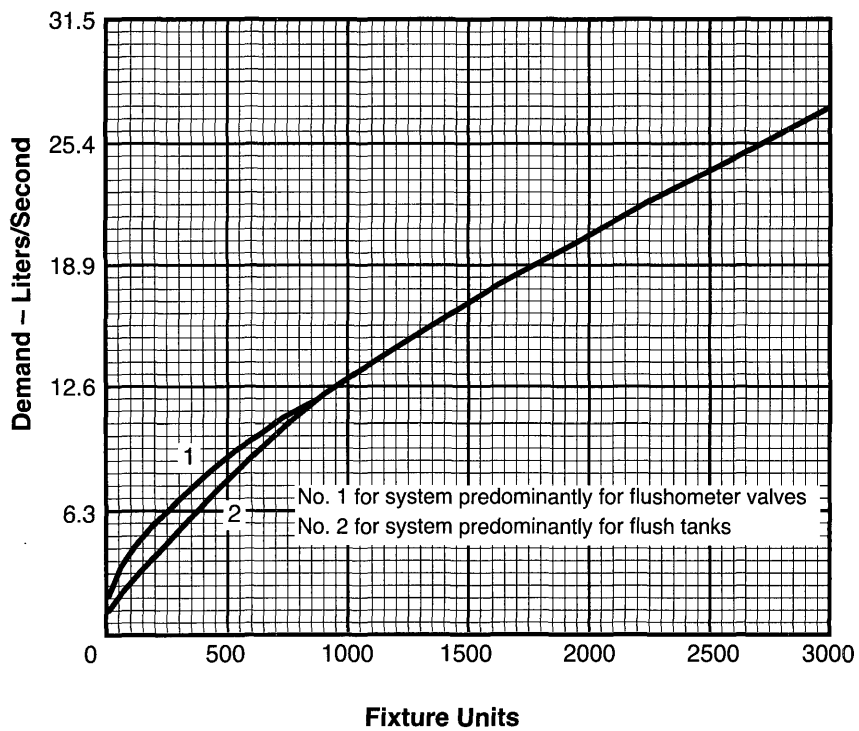

**Chart A-3  
Enlarged Scale Demand Load**

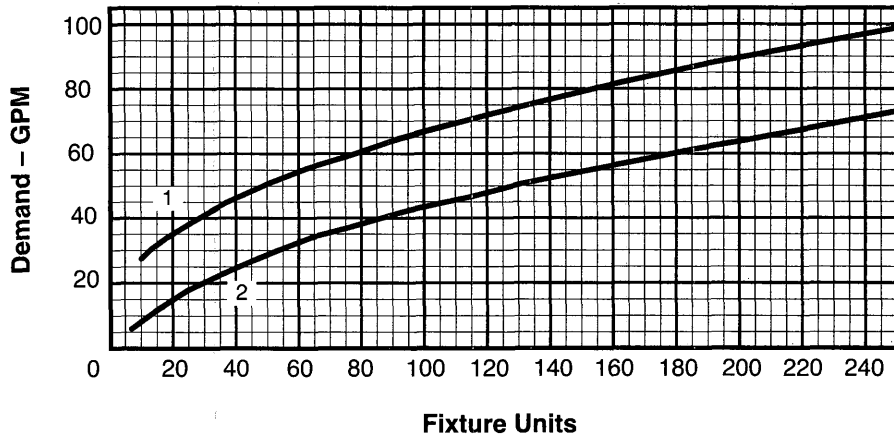

**Chart A-3 (Metric)  
Enlarged Scale Demand Load**

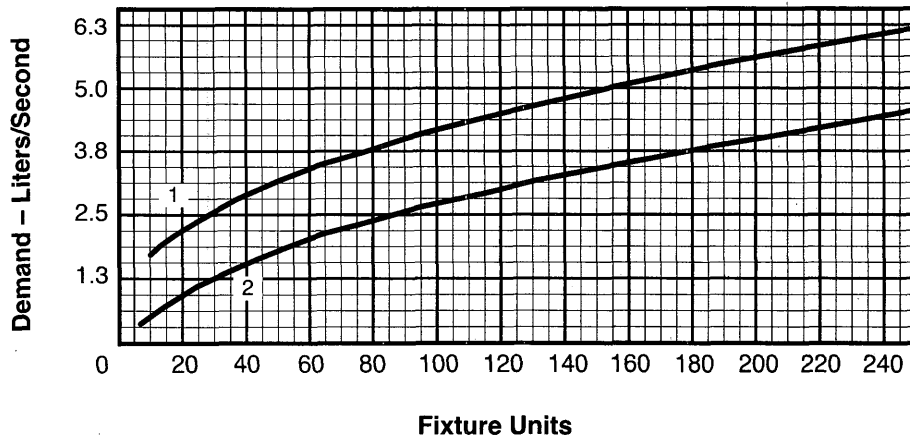

Chart A-4

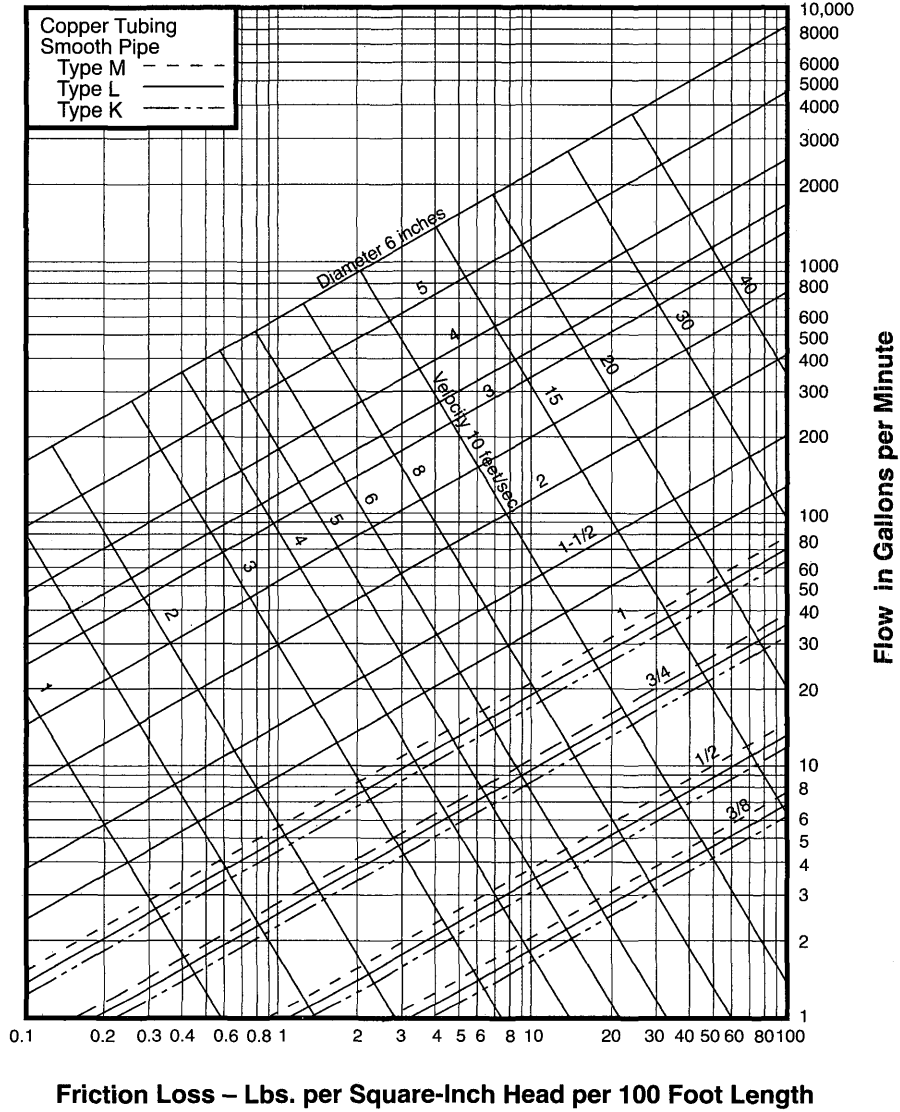



Chart A-4 (Metric)

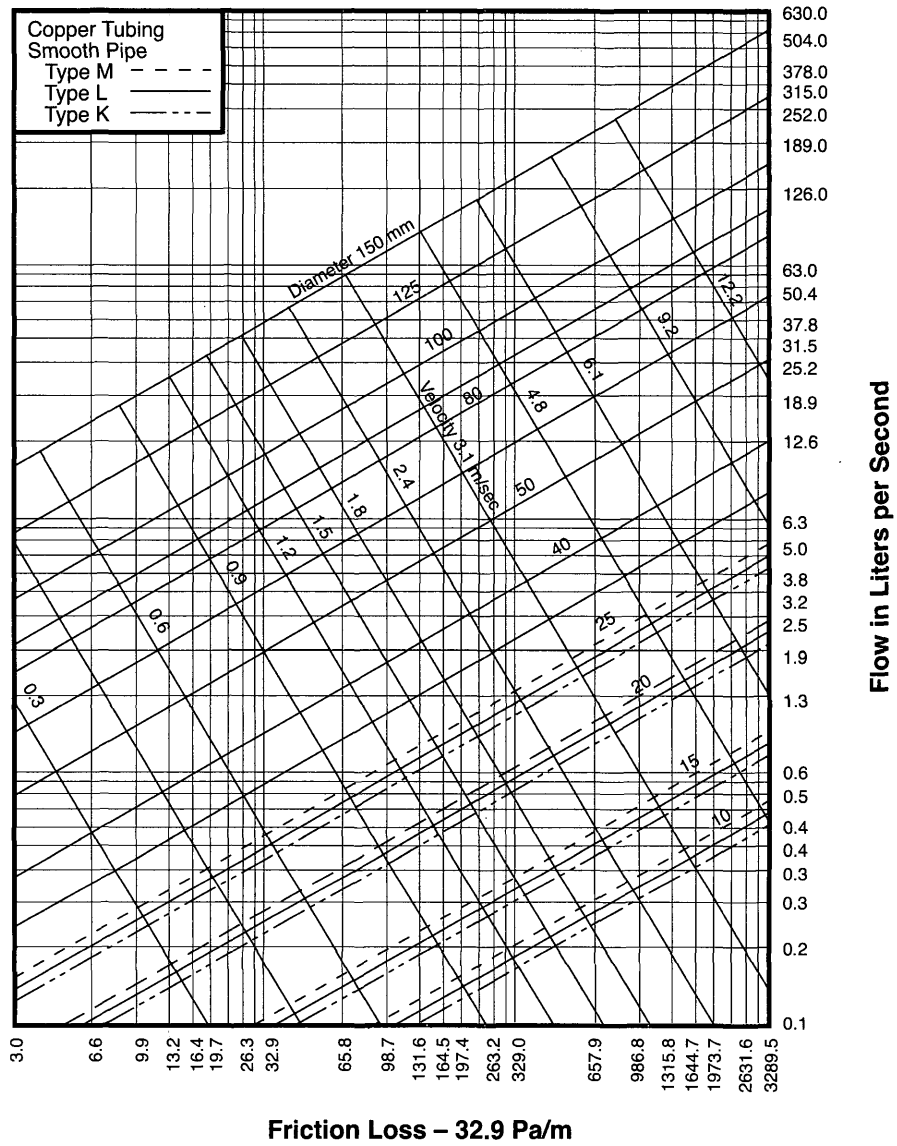

Chart A-5

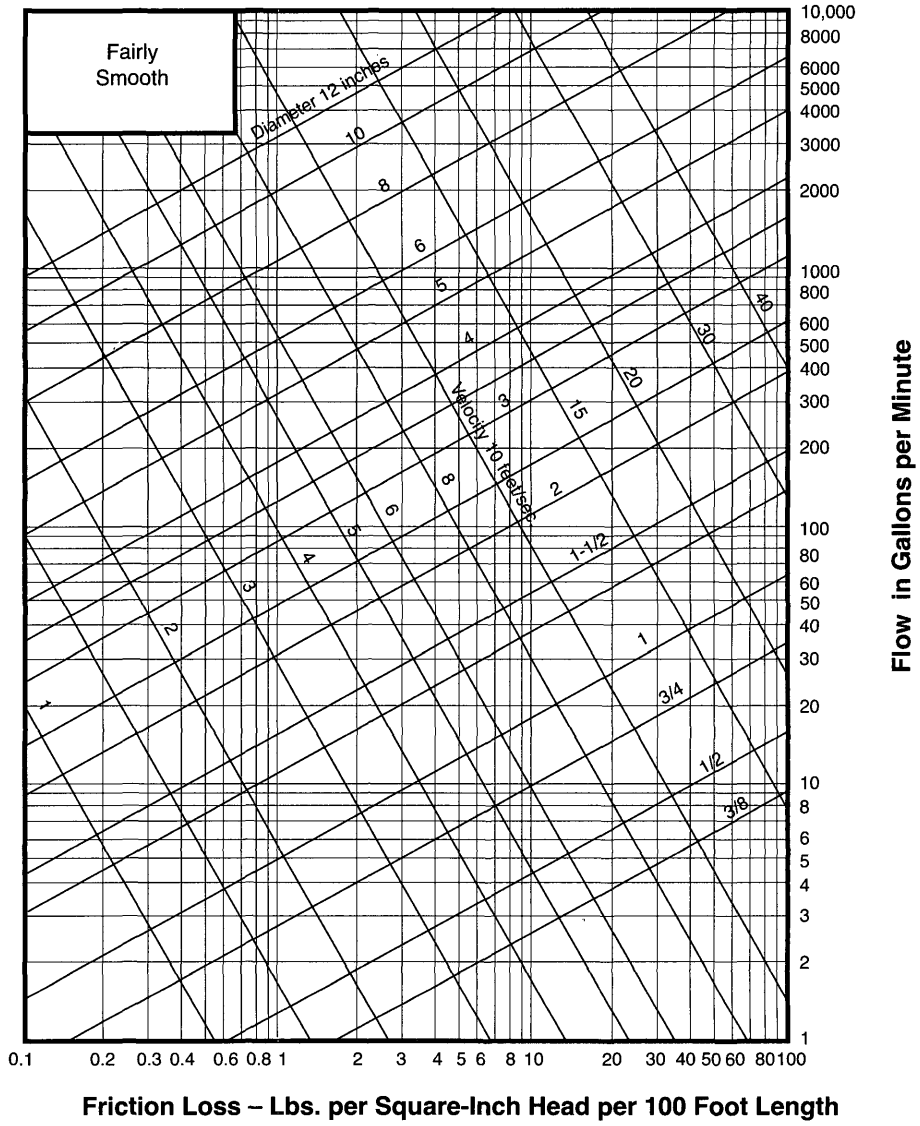

Chart A-5 (Metric)

Fairly Smooth

CHART A-5 (Metric)

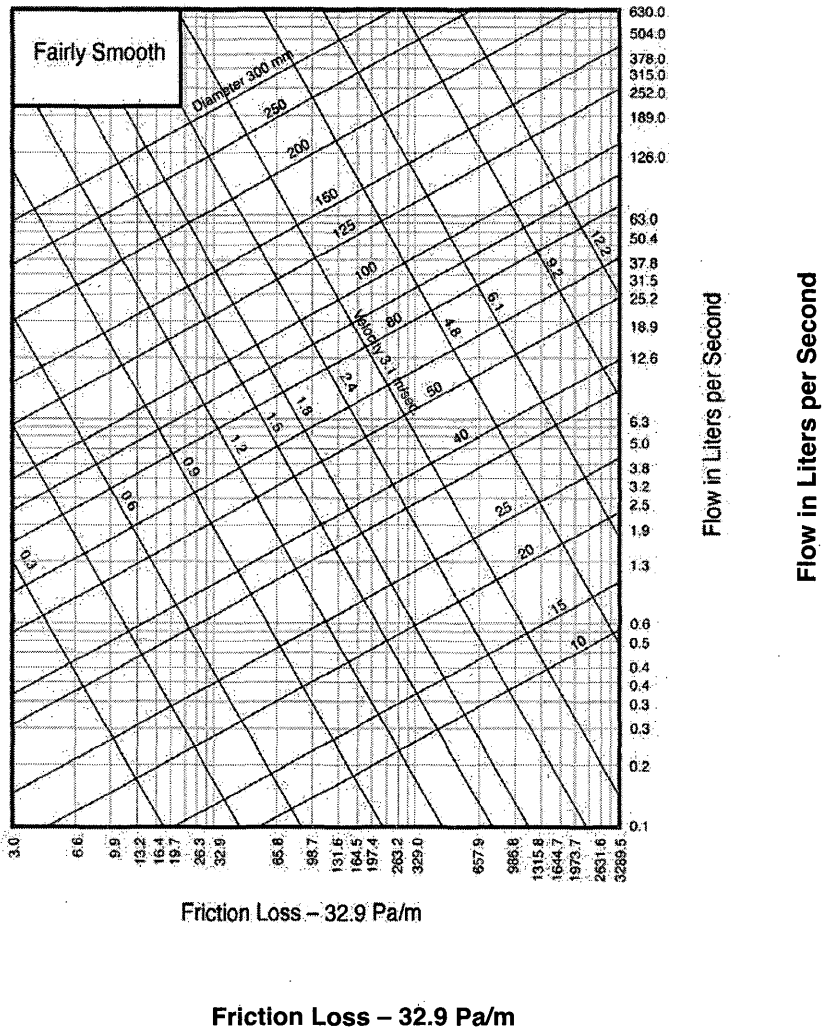

Chart A-6

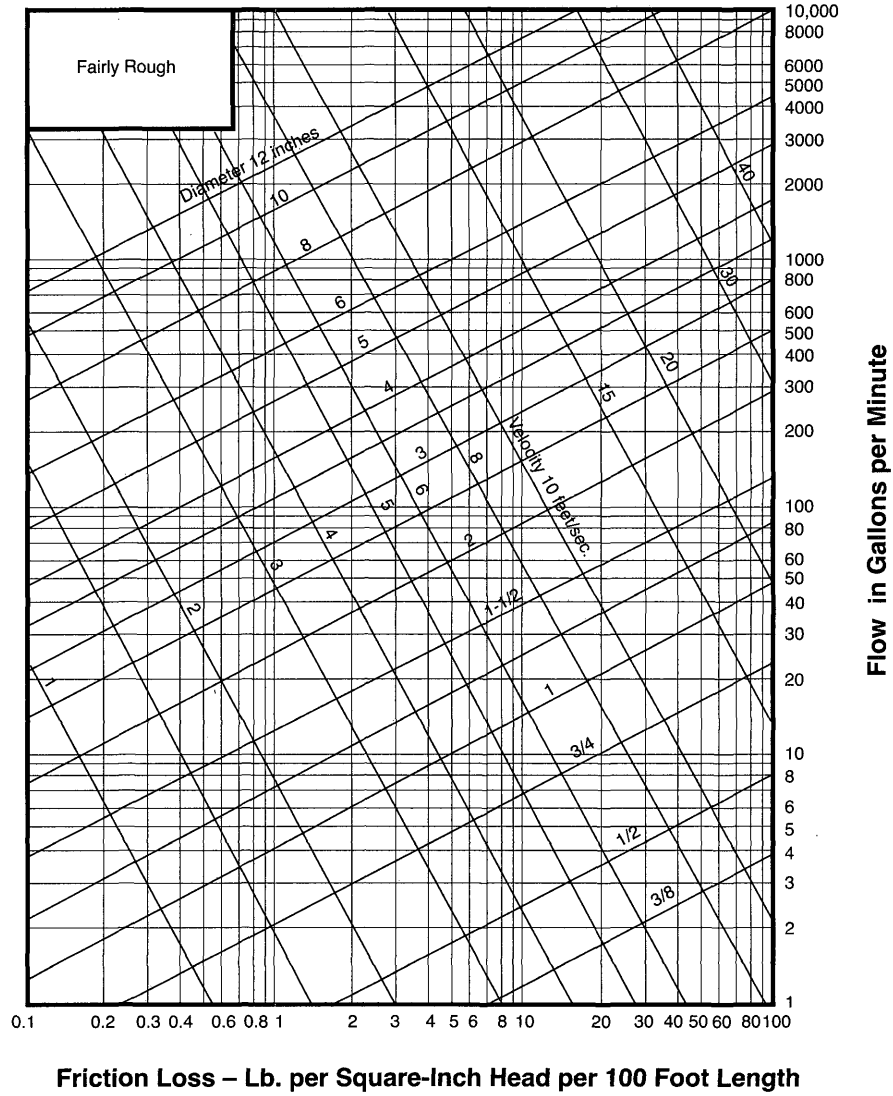

Chart A-6 (Metric)

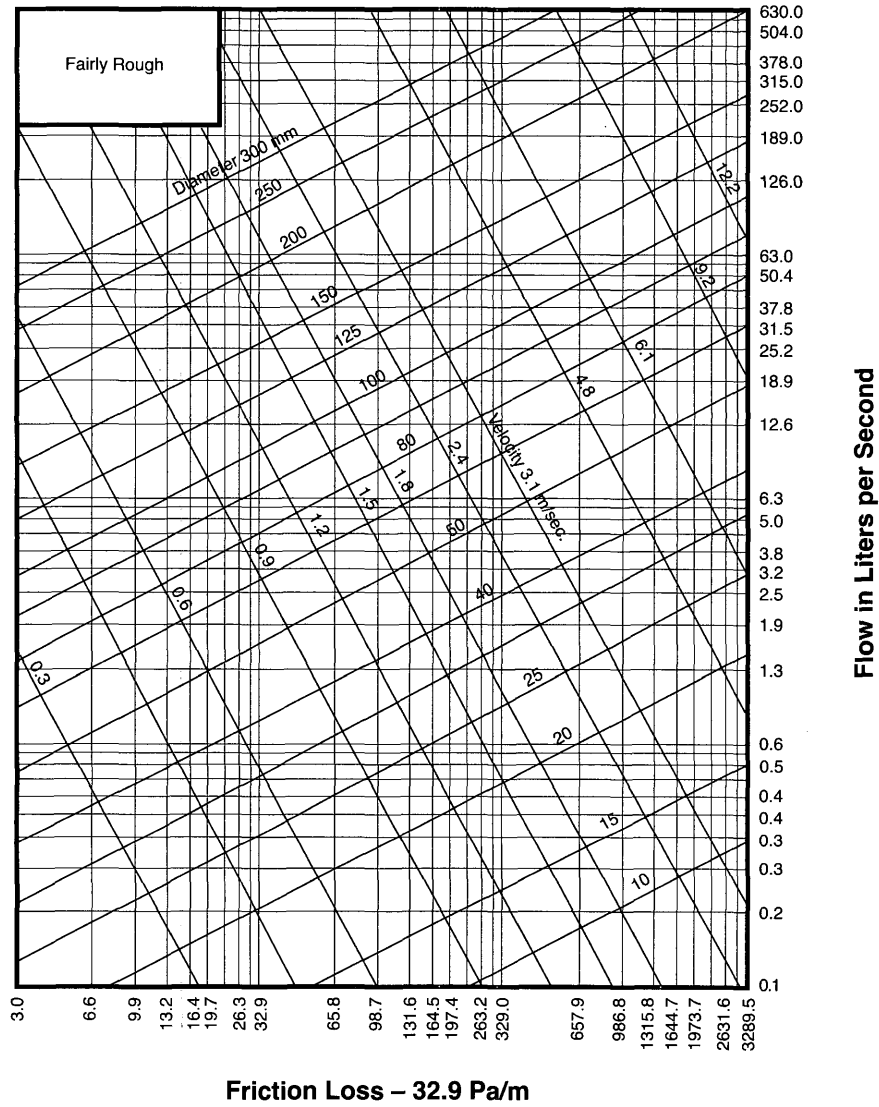

Chart A-7

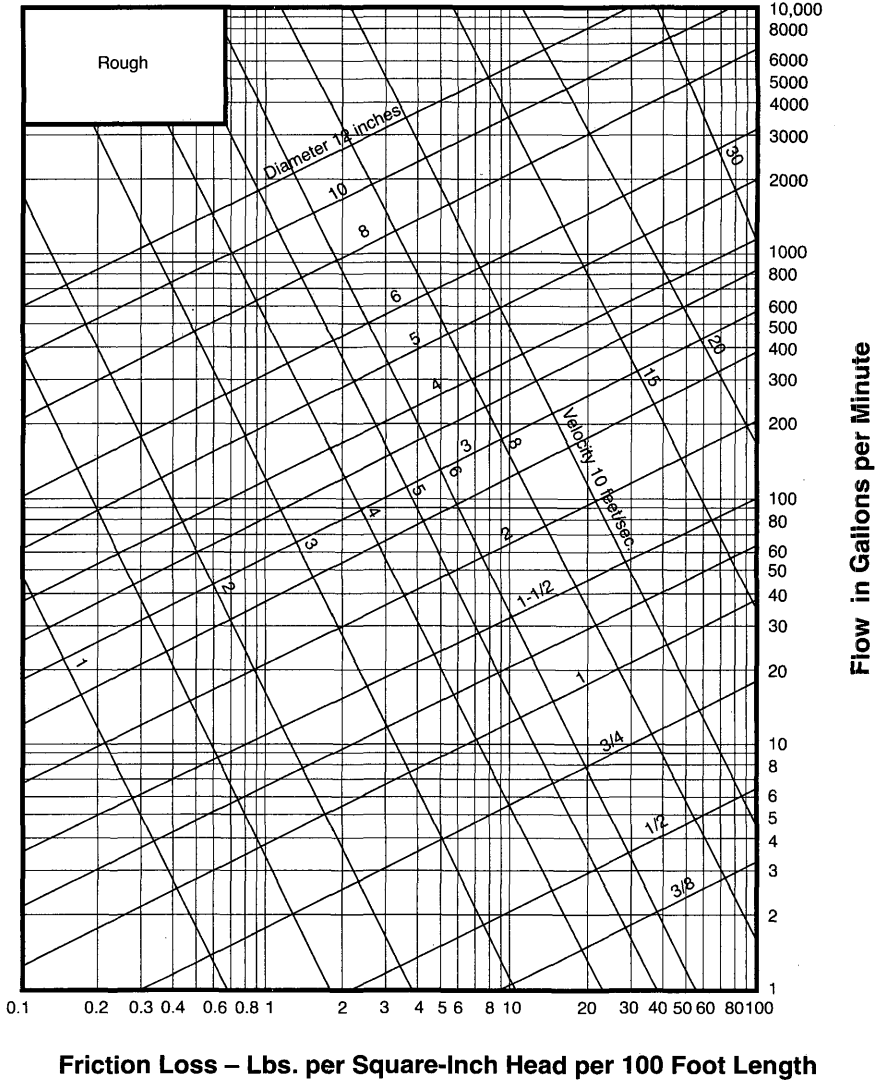
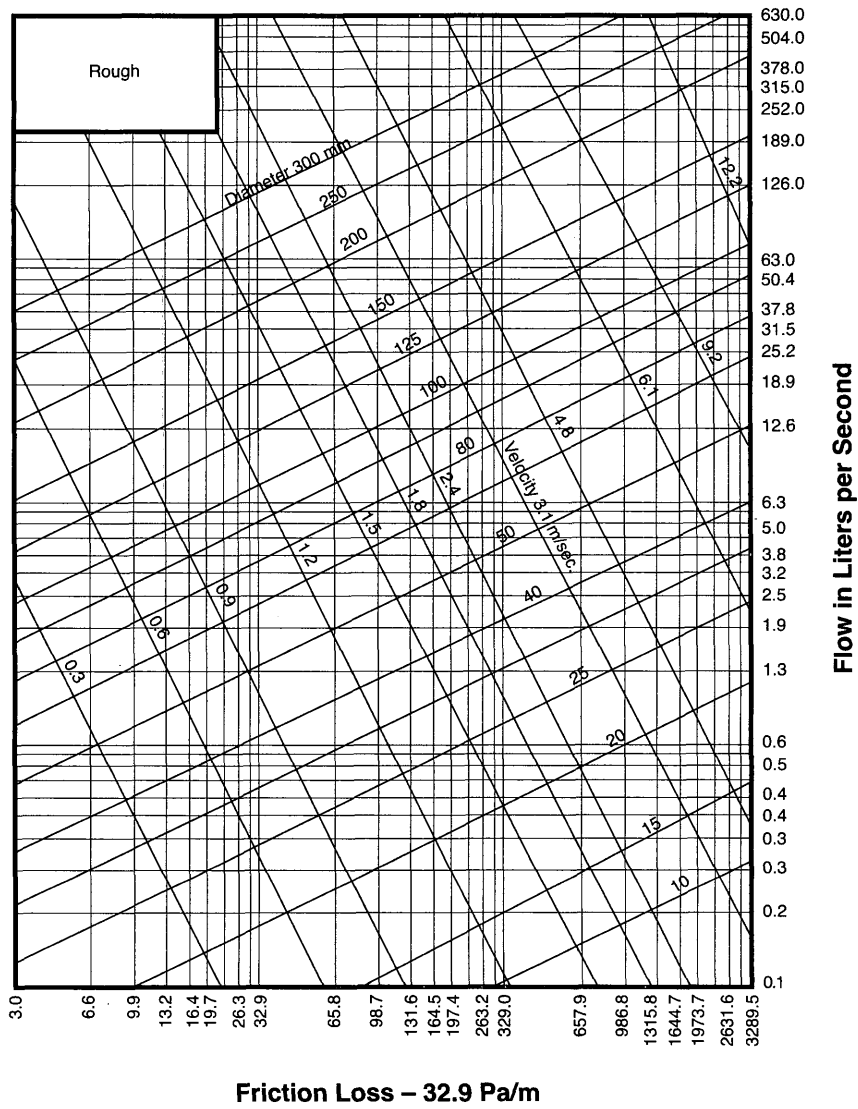

Chart A-7 (Metric)



## APPENDIX B

### EXPLANATORY NOTES ON COMBINATION WASTE AND VENT SYSTEMS

(See Section 910.0 for the UPC for specific limitations.)

**B 1** Combination waste and vent systems, as outlined in Section 910.0 of this code, cover the horizontal wet venting of a series of traps by means of a common waste and vent pipe. Line sizes at least two (2) pipe sizes larger than those required for a conventional system are designed to maintain a wetted perimeter or flow line low enough in the waste pipe to allow adequate air movement in the upper portion, thus balancing the system. Sinks, lavatories, and other fixtures that rough in above the floor, should not be permitted on a combination waste and vent system, which at best is merely an expedient designed to be used in locations where it would be structurally impractical to provide venting in the conventional manner.

Combination waste and vent systems are intended primarily for extensive floor or shower drain installations where separate venting is not practical, for floor sinks in markets, demonstration or work tables in school buildings, or for similar applications where the fixtures are not adjacent to walls or partitions. Due to its oversize characteristics, such a waste system is not self-scouring, and consequently care should be exercised as to the type of fixtures connected thereto and to the location of cleanouts. In view of its grease-producing potential, restaurant kitchen equipment should not be connected to a combination waste and vent system.

**B 2** Caution must be exercised to exclude appurtenances delivering large quantities or surges of water (such as pumps, sand interceptors, etc.) from combination waste and vent systems in order that adequate venting will be maintained. Small fixtures with a waste-producing potential of less than seven and one-half (7-1/2) gallons per minute (0.5 L/sec.) may be safely assigned a loading value of one (1) unit. Long runs should be laid at the minimum permissible slope in order to keep tailpieces as short as possible. Tailpieces should not exceed two (2) feet (610 mm) in length, which may necessitate slopes up to forty-five (45) degrees (0.79 rad) (see definition of *horizontal pipe*) on some branches.

**B 3** It is essential that the pneumatics of such a system be properly engineered, as the air pressure within the line must at all times balance that of outside atmosphere in order to prevent either trap seal loss or air locking between traps. Long mains shall be provided with additional relief vents located at intervals not exceeding one hundred (100) feet (30,480 mm). Each such relief vent should equal at least one-half (1/2) of the inside cross-sectional area of the drainpipe served.

**B 4** Trap sizes are required to be equivalent to the branches they serve (two (2) pipe sizes larger than normal), and tailpieces between fixtures or floor drains and such traps should be reduced to normal size.

**B 5** Duplicate layout drawings of each such proposed piping system must be presented to the Authority Having Jurisdiction and approval obtained before any installation is made. Complicated layouts should be checked by qualified personnel.

#### **B 5.1 Example of Sizing.**

A floor drain normally required two (2) inch (50 mm) trap and waste. On a combination waste and vent system, both trap and waste must be increased two (2) pipe sizes (through 2-1/2" and 3") (65 mm and 80 mm) which would make the trap three (3) inch (76 mm). Pipe sizes recognized for this purpose are 2", 2-1/2", 3", 3-1/2", 4", 4-1/2", 5", 6", etc. (50 mm, 65 mm, 80 mm, 90 mm, 100 mm, 115 mm, 125 mm, 150 mm, etc.). The tailpiece between the floor drain and its trap should be two (2) inches (51 mm) (or normal size) to ensure that the amount of wastewater entering the trap only partially fills the waste branch. A three (3) inch (80 mm) floor drain would thus require a four (4) inch (100 mm) trap, a four (4) inch (100 mm) floor drain, and five (5) inch (125 mm) trap, etc., for the reasons previously stated.

WHEN IN DOUBT, CHECK WITH YOUR LOCAL Authority Having Jurisdiction.





## APPENDIX D

### SIZING STORM WATER DRAINAGE SYSTEMS

#### D 1 Roof Drainage.

The rainfall rates in Table D-1 should be used for design unless higher values are established locally.

#### D 2 Sizing by Flow Rate.

Storm drainage systems can be sized by storm water flow rates, using the appropriate GPM/square foot of rainfall listed in Table D-1 for the local area. Multiplying the listed GPM/square foot by the roof area being drained by each inlet (in square feet) produces the gallons per minute (GPM) of required flow for sizing each drain inlet. The flow rates (GPM) can then be added to determine the flows in each section of the drainage system. Required pipe sizes for various flow rates (GPM) are listed in Table 11-1 and Table 11-2.

#### D 3 Sizing by Roof Area.

Storm drainage systems can be sized using the roof area served by each section of the drainage system.

Maximum allowable roof areas with various rainfall rates are listed in Table 11-1 and Table 11-2, along with the required pipe sizes. Using this method, it may be necessary to interpolate between two listed rainfall rate columns (inches per hour). To determine the allowable roof area for a listed pipe size at a listed slope, divide the allowable square feet of roof for a one (1) inch (25.4 mm/h) rainfall rate by the listed rainfall rate for the local area. For example, the allowable roof area for a six (6) inch (152 mm) drain at one-eighth (1/8) inch (3.2 mm) slope with a rainfall rate of 3.2 inches (81 mm/h) is  $21,400/3.2 = 6688$  square feet (621.3 m<sup>2</sup>).

#### D 4 Capacity of Rectangular Scuppers.

Table D-2 lists the discharge capacity of rectangular roof scuppers of various widths with various heads of water. The maximum allowable level of water on the roof should be obtained from the structural engineer, based on the design of the roof.

**TABLE D-1**  
**Maximum Rates of Rainfall for Various Cities**

The rainfall rates in this table are based on U.S. Weather Bureau  
Technical Paper No. 40, Chart 14: 100-Year 60-Minute Rainfall (inches).

States and Cities	Storm Drainage 60-Minute Duration, 100-Year Return	
	Inches/Hour	GPM/Square Foot
<b>ALABAMA</b>		
Birmingham	3.7	0.038
Huntsville	3.3	0.034
Mobile	4.5	0.047
Montgomery	3.8	0.039
<b>ALASKA</b>		
Aleutian Islands	1.0	0.010
Anchorage	0.6	0.006
Bethel	0.8	0.008
Fairbanks	1.0	0.010
Juneau	0.6	0.006
<b>ARIZONA</b>		
Flagstaff	2.3	0.024
Phoenix	2.2	0.023
Tucson	3.0	0.031

TABLE D-1 Continued

States and Cities	Storm Drainage 60-Minute Duration, 100-Year Return	
	Inches/Hour	GPM/Square Foot
<b>ARKANSAS</b>		
Eudora	3.8	0.039
Ft. Smith	3.9	0.041
Jonesboro	3.5	0.036
Little Rock	3.7	0.038
<b>CALIFORNIA</b>		
Eureka	1.5	0.016
Lake Tahoe	1.3	0.014
Los Angeles	2.0	0.021
Lucerne Valley	2.5	0.026
Needles	1.5	0.016
Palmdale	3.0	0.031
Redding	1.5	0.016
San Diego	1.5	0.016
San Francisco	1.5	0.016
San Luis Obispo	1.5	0.016
<b>COLORADO</b>		
Craig	1.5	0.016
Denver	2.2	0.023
Durango	1.8	0.019
Stratton	3.0	0.031
<b>CONNECTICUT</b>		
Hartford	2.8	0.029
New Haven	3.0	0.031
<b>DELAWARE</b>		
Dover	3.5	0.036
Rehobeth Beach	3.6	0.037
<b>DISTRICT OF COLUMBIA</b>		
Washington	4.0	0.042
<b>FLORIDA</b>		
Daytona Beach	4.0	0.042
Ft. Myers	4.0	0.042
Jacksonville	4.3	0.045
Melbourne	4.0	0.042
Miami	4.5	0.047
Palm Beach	5.0	0.052
Tampa	4.2	0.044
Tallahassee	4.1	0.043
<b>GEORGIA</b>		
Atlanta	3.5	0.036
Brunswick	4.0	0.042
Macon	3.7	0.038
Savannah	4.0	0.042
Thomasville	4.0	0.042

TABLE D-1 Continued

States and Cities	Storm Drainage 60-Minute Duration, 100-Year Return	
	Inches/Hour	GPM/Square Foot
<b>HAWAII</b>		
Rainfall rates in the Hawaiian Islands vary from 1-1/2 inches/hour to 8 inches/hour depending on location and elevation. Consult local data.		
<b>IDAHO</b>		
Boise	1.0	0.010
Idaho Falls	1.2	0.012
Lewiston	1.0	0.010
Twin Falls	1.1	0.011
<b>ILLINOIS</b>		
Chicago	2.7	0.028
Harrisburg	3.1	0.032
Peoria	2.9	0.030
Springfield	3.0	0.031
<b>INDIANA</b>		
Evansville	3.0	0.031
Indianapolis	2.8	0.029
Richmond	2.7	0.028
South Bend	2.7	0.028
<b>IOWA</b>		
Council Bluffs	3.7	0.038
Davenport	3.0	0.031
Des Moines	3.4	0.035
Sioux City	3.6	0.037
<b>KANSAS</b>		
Goodland	3.5	0.036
Salina	3.8	0.039
Topeka	3.8	0.039
Wichita	3.9	0.041
<b>KENTUCKY</b>		
Bowling Green	2.9	0.030
Lexington	2.9	0.030
Louisville	2.8	0.029
Paducah	3.0	0.031
<b>LOUISIANA</b>		
Monroe	3.8	0.039
New Orleans	4.5	0.047
Shreveport	4.0	0.042
<b>MAINE</b>		
Bangor	2.2	0.023
Kittery	2.4	0.025
Millinocket	2.0	0.021

TABLE D-1 Continued

States and Cities	Storm Drainage 60-Minute Duration, 100-Year Return	
	Inches/Hour	GPM/Square Foot
<b>MARYLAND</b>		
Baltimore	3.6	0.037
Frostburg	2.9	0.030
Ocean City	3.7	0.038
<b>MASSACHUSETTS</b>		
Adams	2.6	0.027
Boston	2.7	0.028
Springfield	2.7	0.028
<b>MICHIGAN</b>		
Detroit	2.5	0.026
Grand Rapids	2.6	0.027
Kalamazoo	2.7	0.028
Sheboygan	2.1	0.022
Traverse City	2.2	0.023
<b>MINNESOTA</b>		
Duluth	2.6	0.027
Grand Forks	2.5	0.026
Minneapolis	3.0	0.031
Worthington	3.4	0.035
<b>MISSISSIPPI</b>		
Biloxi	4.5	0.047
Columbus	3.5	0.036
Jackson	3.8	0.039
<b>MISSOURI</b>		
Independence	3.7	0.038
Jefferson City	3.4	0.035
St. Louis	3.2	0.033
Springfield	3.7	0.038
<b>MONTANA</b>		
Billings	1.8	0.019
Glendive	2.5	0.026
Great Falls	1.8	0.019
Missoula	1.3	0.014
<b>NEBRASKA</b>		
Omaha	3.6	0.037
North Platte	3.5	0.036
Scotts Bluff	2.8	0.029
<b>NEVADA</b>		
Las Vegas	1.5	0.016
Reno	1.2	0.012
Winnemucca	1.0	0.010

TABLE D-1 Continued

States and Cities	Storm Drainage 60-Minute Duration, 100-Year Return	
	Inches/Hour	GPM/Square Foot
<b>NEW HAMPSHIRE</b>		
Berlin	2.2	0.023
Manchester	2.5	0.026
<b>NEW JERSEY</b>		
Atlantic City	3.4	0.035
Paterson	3.0	0.031
Trenton	3.2	0.033
<b>NEW MEXICO</b>		
Albuquerque	2.0	0.021
Carlsbad	2.6	0.027
Gallup	2.1	0.022
<b>NEW YORK</b>		
Binghamton	2.4	0.025
Buffalo	2.3	0.024
New York City	3.1	0.032
Schenectady	2.5	0.026
Syracuse	2.4	0.025
<b>NORTH CAROLINA</b>		
Asheville	3.2	0.033
Charlotte	3.4	0.035
Raleigh	4.0	0.042
Wilmington	4.4	0.046
<b>NORTH DAKOTA</b>		
Bismarck	2.7	0.028
Fargo	2.9	0.030
Minot	2.6	0.027
<b>OHIO</b>		
Cincinnati	2.8	0.029
Cleveland	2.4	0.025
Columbus	2.7	0.028
Toledo	2.6	0.027
Youngstown	2.4	0.025
<b>OKLAHOMA</b>		
Boise City	3.4	0.035
Muskogee	4.0	0.042
Oklahoma City	4.1	0.043
<b>OREGON</b>		
Medford	1.3	0.014
Ontario	1.0	0.010
Portland	1.3	0.014

TABLE D-1 Continued

States and Cities	Storm Drainage 60-Minute Duration, 100-Year Return	
	Inches/Hour	GPM/Square Foot
<b>PENNSYLVANIA</b>		
Erie	2.4	0.025
Harrisburg	2.9	0.030
Philadelphia	3.2	0.033
Pittsburgh	2.5	0.026
Scranton	2.8	0.029
<b>RHODE ISLAND</b>		
Newport	3.0	0.031
Providence	2.9	0.030
<b>SOUTH CAROLINA</b>		
Charleston	4.1	0.043
Columbia	3.5	0.036
Greenville	3.3	0.034
<b>SOUTH DAKOTA</b>		
Lemmon	2.7	0.028
Rapid City	2.7	0.028
Sioux Falls	3.4	0.035
<b>TENNESSEE</b>		
Knoxville	3.1	0.032
Memphis	3.5	0.036
Nashville	3.0	0.031
<b>TEXAS</b>		
Corpus Christi	4.6	0.048
Dallas	4.2	0.044
El Paso	2.0	0.021
Houston	4.6	0.048
Lubbock	3.3	0.034
San Antonio	4.4	0.046
<b>UTAH</b>		
Bluff	2.0	0.021
Cedar City	1.5	0.016
Salt Lake City	1.3	0.014
<b>VERMONT</b>		
Bennington	2.5	0.026
Burlington	2.3	0.024
Rutland	2.4	0.025
<b>VIRGINIA</b>		
Charlottesville	3.4	0.035
Norfolk	4.0	0.042
Richmond	4.0	0.042
Roanoke	3.3	0.034

TABLE D-1 Continued

States and Cities	Storm Drainage 60-Minute Duration, 100-Year Return	
	Inches/Hour	GPM/Square Foot
<b>WASHINGTON</b>		
Seattle	1.0	0.010
Spokane	1.0	0.010
Walla Walla	1.0	0.010
<b>WEST VIRGINIA</b>		
Charleston	2.9	0.030
Martinsburg	3.0	0.031
Morgantown	2.7	0.028
<b>WISCONSIN</b>		
Green Bay	2.5	0.026
La Cross	2.9	0.030
Milwaukee	2.7	0.028
Wausau	2.5	0.026
<b>WYOMING</b>		
Casper	1.9	0.020
Cheyenne	2.5	0.026
Evaston	1.3	0.014
Rock Springs	1.4	0.015



**TABLE D-2**  
**Discharge from Rectangular Scuppers – Gallons per Minute**

Water Head, Inches	Width of Scupper in Inches					
	6	12	18	24	30	36
1/2	6	13	19	25	32	38
1	17	35	53	71	89	107
1-1/2	31	64	97	130	163	196
2		98	149	200	251	302
2-1/2		136	207	278	349	420
3		177	271	364	458	551
3-1/2			339	457	575	693
4			412	556	700	844

**TABLE D-2 (Metric)**  
**Discharge from Rectangular Scuppers – Liters per Second**

Water Head (mm)	Width of Scupper in Millimeters					
	152	305	457	610	762	914
13	0.4	0.8	1.2	1.6	2.0	2.4
25	1.1	2.2	3.3	4.5	5.6	6.8
38	2.0	4.0	6.1	8.2	10.3	12.4
51		6.2	9.4	12.6	15.8	19.1
64		8.6	13.1	17.5	22.0	26.5
76		11.2	17.1	23.0	28.9	34.8
89			21.4	28.8	36.3	43.7
102			26.0	35.1	44.2	53.3

## Notes:

1. Table D-2 is based on discharge over a rectangular weir with end contractions.
2. Head is the depth of water above bottom of the scupper opening.
3. The height of the scupper opening should be at least two (2) times the design head.
4. Coordinate the allowable head of water with the structural design of the roof.

# APPENDIX E

## MANUFACTURED/MOBILE HOME PARKS AND RECREATIONAL VEHICLE PARKS

### Part A

#### Manufactured/Mobile Home (M/H) Park Definitions and General Requirements

##### E 1 Manufactured/Mobile Home.

A structure transportable in one (1) or more sections, which in the traveling mode is eight (8) body feet (2,438 mm) or more in width and forty (40) body feet (12,192 mm) or more in length or, when erected on site, is three hundred twenty (320) or more square feet (29.7 m<sup>2</sup>), and which is built on a permanent chassis, and designed to be used as a dwelling with or without a permanent foundation when connected to the required utilities. It includes the plumbing, heating, air conditioning, and electrical systems contained therein. For further clarification of definition, see Federal Regulation 24 CFR.

**E 1.1 Manufactured/Mobile Home Accessory Building or Structure.** A building or structure which is an addition to or supplements the facilities provided to an M/H. It is not a self-contained, separate, habitable building or structure. Examples are awnings, cabanas, ramadas, storage structures, carports, fences, windbreaks, or porches.

**E 2 Manufactured/Mobile Home Lot.** A portion of an M/H park designed for the accommodation of one M/H and its accessory buildings or structures for the exclusive use of the occupants.

**E 3 Manufactured/Mobile Home Park.** A parcel (or contiguous parcels) of land which has been so designated and improved that it contains two (2) or more M/H lots available to the general public for the placement thereon of M/H for occupancy.

### General

**E 4** The M/H park plumbing and drainage systems shall be designed and installed in accordance with the requirements of this appendix and the requirements of this code.

**E 5** Before any plumbing or sewage disposal facilities are installed or altered in any M/H park, duplicate plans and specifications shall be filed and proper permits obtained from the department or departments having jurisdiction. Plans shall show in detail:

(A) Plot plan of the park drawn to scale, indicating elevations, property lines,

driveways, existing or proposed buildings and the sizes of M/H lots.

- (B) Complete specification and piping layout of proposed plumbing systems or alteration.
- (C) Complete specification and layout of proposed sewage disposal system or alteration.
- (D) The nature and extent of the work proposed, showing clearly that such work will conform to the provisions of this code.

### Part B

#### Manufactured/Mobile Home Park Drainage System Construction

##### E 6 Drainage Systems.

A drainage system shall be provided in all M/H parks for conveying and disposing of all sewage. Wherever feasible, connection shall be made to a public system. All new improvements shall be designed, constructed, and maintained in accordance with applicable laws and regulations. Where the drainage lines of the M/H park are not connected to a public sewer, all proposed sewage disposal facilities shall be approved by the Authority Having Jurisdiction prior to construction.

##### E 7 Material.

Pipe and fittings installed underground in M/H park drainage systems shall be of material approved for the purpose. M/H lot drainage inlets and extensions to grade shall be of material approved for underground use within a building.

##### E 8 Drainage (Sewage) Lines.

All drainage (sewage) collection lines shall be located in trenches of sufficient depth to be free of breakage from traffic or other movements and shall be separated from the park water supply system as specified in this code. Drainage (sewage) lines shall have a minimum size and slope as specified in Tables E-1 and E-2.

##### E 9 M/H Lot Drainage Inlet and Lateral.

- (A) **Size.** Each lot shall be provided with a drainage inlet not less than three (3) inches (76 mm) in diameter.
- (B) The lateral line from the inlet to the sewage drain line shall slope at least one-fourth (1/4) inch per foot (20.9 mm/m). All joints shall be watertight.

- (C) All materials used for drainage connections between an M/H and the lot drainage inlet shall be semi-rigid, corrosion-resistant, non-absorbent, and durable. The inner surface shall be smooth.
- (D) Provision shall be made for plugging or capping the sewage drain inlet when an M/H does not occupy the lot. Surface drainage shall be diverted away from the inlet. The rim of the inlet shall extend not more than four (4) inches (102 mm) above ground elevation.

**E 10 Location of Lot Drain Inlet.**

Each lot drainage inlet shall be located in the rear third section and within four (4) feet (1219 mm) of the proposed location of the M/H.

**E 11 Pipe Size.**

- (A) Each M/H lot drainage inlet shall be assigned a waste loading value of twelve (12) fixture units, and each park drainage

system shall be sized according to Table E-1 or as provided herein. Drainage laterals shall be not less than three (3) inches (76 mm) in diameter.

- (B) A park drainage system which exceeds the fixture unit loading of Table E-1 or in which the grade and slope of drainage pipe does not meet the minimum specified in Table E-2 shall be designed by a registered professional engineer.

**E 12 M/H Drain Connector.**

- (A) An M/H shall be connected to the lot drainage inlet by means of a drain connector consisting of approved pipe not less than Schedule 40, appropriate fittings and connectors, and not less in size than the M/H drainage outlet. An approved cleanout shall be provided between the M/H and the lot drainage inlet. The fitting connected to the lot drainage inlet shall be a

**TABLE E-1  
Drainage Pipe Diameter and Number of Fixture Units on Drainage System**

	Size of Drainage Pipe		Maximum Number of Fixture Units
	Inches	mm	
	2*	51	8
	3	76	35
	4	102	256
	5	127	428
	6	152	720
	8	203	2640
	10	254	4680
	12	305	8200

\*Except six unit fixtures

**TABLE E-2  
Minimum Grade and Slope of Drainage Pipe**

Pipe Size		Slope per		Pipe Size		Slope per	
		100 ft. (30.5 m)				100 ft. (30.5 m)	
Inches	mm	Inches	mm	Inches	mm	Inches	mm
2	51	25	635	6	152	8	203
3	76	25	635	8	203	4	102
4	102	15	381	10	254	3-1/2	89
5	127	11	279	12	305	3	76

directional fitting to discharge the flow into the drainage inlet.

- (B) A drain connector shall be installed or maintained with a grade not less than one-fourth (1/4) inch per foot (20.9 mm/m). A drain connector shall be gastight and no longer than necessary to make the connection between the M/H outlet and the drain inlet on the lot. A flexible connector may be used at the lot drainage inlet area only. Each lot drainage inlet shall be capped gastight when not in use.

### Part C

#### M/H Park Water Supply

##### E 13 General Requirements.

An accessible and adequate supply of potable water shall be provided in each M/H park. Where a public supply of water of satisfactory quantity, quality, and pressure is available at or within the boundary of the park site, connection shall be made thereto and its supply used exclusively. When a satisfactory public water supply is not available, a private water supply system shall be developed and used as approved by the Authority Having Jurisdiction.

##### E 14 Lot Service Outlet Size.

Each M/H lot shall be provided with a water service outlet delivering potable water. The water service outlet riser shall be not less than three-fourths (3/4) inch (19.1 mm) nominal pipe size and capable of delivering twelve (12) fixture units.

##### E 15 Location of Water Service.

Each lot water service outlet shall be located in the rear third section and within four (4) feet (1219 mm) of the proposed location of the M/H.

##### E 16 Pressure.

Each M/H park water distribution system shall be so designed and maintained as to provide a pressure of not less than twenty (20) pounds per square inch (138 kPa) at each M/H lot at maximum operating conditions.

##### E 17 Water Distribution Piping.

Park water distribution systems shall be designed to deliver a minimum of twelve (12) fixture units of water to each lot and installed with materials as set forth in Chapter 6 and/or Appendix A of this code.

##### E 18 Shutoff Valve.

A separate water shutoff valve shall be installed in each water service outlet at each M/H lot. Where a listed backflow protective device is installed, the service shutoff shall be located on the supply side of such device.

##### E 19 Backflow Preventer.

Whenever a condition exists in the plumbing of a M/H that may create a cross connection, a listed backflow preventer shall be installed in the water service line to the M/H at or near the water service outlet. When a hose bibb or outlet is installed on the supply outlet riser in addition to the service connector, a listed backflow preventer shall be installed on each additional outlet.

##### E 20 Pressure Relief Valve.

Whenever it is required to install a backflow preventer at the M/H lot service outlet, a listed pressure relief valve shall be installed in the water service line on the discharge side of the backflow preventer. Pressure relief valves shall be set to release at a pressure not to exceed one hundred fifty (150) pounds per square inch (1034 kPa). Pressure relief valves shall discharge toward the ground. Backflow preventers and pressure relief valves shall be at least twelve (12) inches (305 mm) above the ground.

##### E 21 Mechanical Protection.

All park water service outlets, backflow preventers, and pressure relief valves shall be protected from damage by vehicles or other causes. Such protection may consist of posts, fencing, or other permanent barriers.

##### E 22 M/H Water Connector.

An M/H shall be connected to the park water service outlet by a flexible connector, such as copper tubing or other approved material not less than three quarter (3/4) inch nominal (19.1 mm) interior diameter.

##### E 23 Water Conditioning Equipment.

- (A) **Permit Required.** A permit shall be obtained from the Authority Having Jurisdiction prior to installing any water conditioning equipment on an M/H lot. Approval of the park operator is required on all applications for a permit to install such equipment. If the water conditioning equipment is of the regenerating type, and the park drainage system discharges into a public sewer, approval of the sanitary district or agency having jurisdiction over the public sewer is required.
- (B) **Approval.** Regenerating water-conditioning equipment shall be listed and labeled by an approved listing agency.
- (C) **Installation.** Regenerating units shall discharge the effluent of regeneration into a trap not less than one and one-half (1-1/2) inches (38 mm) in diameter connected to the

M/H park drainage system. An approved air gap shall be installed on the discharge line a minimum of twelve (12) inches (305 mm) above the ground.

#### **E 24 Testing.**

Installations shall be tested and inspected as required by Chapter 3 of this code.

### **Part D Fuel Supply**

#### **E 25 General.**

All fuel gas piping systems serving manufactured homes, accessory buildings, or structures and communities shall be designed and constructed in accordance with any applicable provisions of NFPA 54, *National Fuel Gas Code*, and NFPA 58, *Liquefied Petroleum Gas Code*. NFPA 31, *Standard for the Installation of Oil-Burning Equipment*, shall apply to oil fuel-burning systems and shall conform to the criteria of the Authority Having Jurisdiction.

##### **E 25.1 Gas Supply Connections.**

Gas supply connections at sites, where provided from an underground gas supply piping system, shall be located and arranged to permit attachment to an M/H occupying the site in a work-like manner. For the installation of liquefied petroleum gas (LPG) storage systems, the applicable provisions of NFPA 58, *Liquefied Petroleum Gas Code*, shall be followed.

##### **E 25.2 Location of Gas Supply Connection.**

The gas supply to the M/H shall be located within 4 feet (1.22 m) of the M/H stand. [NFPA 501A: Sections 2.3, 2.3.8, 2.4, and 2.4.5.]

**Exception:** The above requirements shall not apply to gas supply connections for manufactured homes located on all-weather wood, concrete, or concrete block foundation systems or on foundations constructed in accordance with the local building code or, in the absence of a local code, with a recognized model building code. [NFPA 501A Section 2.1.3]

#### **E 26 Single and Multiple Manufactured Home Site Fuel Supply Systems.**

##### **E 26.1 Gas Piping Installations.**

##### **E 26.1.1 Gas Supply Connections – Underground Gas Piping.**

Gas supply connections at sites, where provided from an underground gas supply

piping system, shall be located and arranged to permit attachment in a work-like manner to a manufactured home occupying the site. For the installation of LPG storage systems, the provisions of NFPA 58, *Liquefied Petroleum Gas Code*, shall be followed.

**E 26.1.2** Underground gas piping system installations shall comply with any applicable building code and Sections E 26.1.2.1 and E 26.1.2.2.

**E 26.1.2.1** Underground gas piping shall not be installed beneath that portion of an M/H site reserved for the location of a manufactured home or M/H accessory building or structure unless installed in the open-ended gastight conduit of Section E 26.1.2.2.

**E 26.1.2.2** The open-ended gastight conduit shall conform to the following:

- (1) The conduit shall be not less than Schedule 40 pipe that is approved for underground installation beneath buildings.
- (2) The interior diameter of the conduit shall be not less than 0.5 inches (12.7 mm) larger than the outside diameter of the gas piping.
- (3) The conduit shall extend to a point not less than 4 inches (102 mm) beyond the outside wall of the M/H, accessory building or structure, and the outer ends shall not be sealed.
- (4) Where the conduit terminates within an M/H, accessory building or structure, it shall be readily accessible, and the space between the conduit and the gas-piping shall be sealed to prevent leakage of gas into the building.

##### **E 27 Manufactured Home Site Gas Shutoff Valve.**

Each M/H site shall have a listed gas shutoff valve installed upstream of the M/H site gas outlet. The gas shutoff valve shall be located on the outlet riser at a height of not less than 6 inches (152 mm) above grade. A gas shutoff valve shall not be located under any M/H. The outlet shall be equipped with a cap or plug to prevent discharge of gas whenever the M/H site outlet is not connected to an M/H.

**Exception:** All gas shutoff valves for manufactured homes located on foundations constructed in accordance with the local building code or, in the absence of a local code, with a recognized model building code.

##### **E 28 Gas Meters.**

**E 28.1 Support of Meters.** Where installed, gas meters shall be adequately supported by a post or bracket placed on a firm footing or other means providing equivalent support and shall not depend on the gas outlet riser for support.

**E 28.2 Location of Meters.** Each gas meter shall be installed in an accessible location and shall be provided with unions or other fittings so that the meter is removed easily and replaced in an upright position. Meters shall not be installed in unventilated or inaccessible locations or closer than 3 ft (0.91 m) to sources of ignition.

**E 28.3 Meter Shutoff Valve or Cock.** All gas meter installations shall be provided with shutoff valves or cocks located adjacent to and on the inlet side of the meters. In the case of a single meter installation utilizing an LP-Gas container, the container service valve shall be permitted to be used in lieu of the shutoff valve or cock. All gas meter installations shall be provided with test tees located adjacent to and on the outlet side of the meters.

**E 29 Multiple Manufactured Home Site Fuel Distribution and Supply Systems.** [NFPA 501A: Section 2.1, 2.3.11, 2.4, and 2.4.5.]

**E 30 Manufactured Home Community Natural Gas Distribution Systems.**

All underground metallic fuel piping systems shall comply with the cathodic protection requirements of 49 CFR 191 and 192. [NFPA 501A: Section 2.3.1]

**E 31 Manufactured Home Community LPG Supply Systems.**

Where ten or more customers are served by one LPG supply system, the installation of the gas supply system shall be in accordance with 49 CFR 192, *Transportation of Natural and Other Gas by Pipeline: Minimum Federal Safety Standards*. Other liquefied petroleum gas supply systems and the storage and handling of LPG shall be in accordance with NFPA 58, *Liquefied Petroleum Gas Code*. [NFPA 501A: Section 2.3.8.]

**E 32 Installation of Cathodic Protection Systems.**

Where required by the federal standard cited in NFPA 501A Section 2.3.1, cathodic protection shall be installed for corrosion control of buried or submerged metallic gas piping. [NFPA 501A: Section 2.3.6.1 and 2.3.6.2.]

**E 33 Required Gas Supply.**

The minimum hourly volume of gas required at each M/H site outlet or any section of the M/H community gas piping system shall be calculated as shown in Table E 33.1.

**E 34 Gas Pipe Sizing and Pressure.**

**E 34.1** The size of each section of a gas piping system shall be determined in accordance with

NFPA 54, National Fuel Gas Code, or by other standard engineering methods acceptable to the Authority Having Jurisdiction.

**E 34.2** Where all connected appliances are operated at their rated capacity, the supply pressure shall be not less than 4 ounces per square inch [7 in. water column (1743 Pa)]. The gas supply pressure shall not exceed 8 ounces per square inch [14 in. water column (3486 Pa)].

**E 35 Gas Piping Materials.**

**E 35.1 Metal.** Metal gas pipe shall be standard-weight wrought iron or steel (galvanized or black), yellow brass containing not more than 75 percent copper, or internally tinned or treated copper of iron pipe size. Galvanizing shall not be considered protection against corrosion.

Seamless copper or steel tubing shall be permitted to be used with gases not corrosive to such material. Steel tubing shall comply with ASTM A 539, *Standard Specification for Electric-Resistance-Welded Coiled Steel Tubing for Gas and Fuel Oil Lines*, or ASTM A 254, *Standard Specification for Copper-Brazed Steel Tubing*. Copper tubing shall comply with ASTM B 88, *Specification for Seamless Copper Water Tubing (Type K or Type L)*, or ASTM B 280, *Specification for Seamless Copper Tubing for Air Conditioning*

**TABLE E-3**  
**Demand Factors for Use in Calculating Gas Piping Systems in M/H Communities**

No. of Manufactured Home Sites	Btu/h per Manufactured Home Site
1	125,000
2	117,000
3	104,000
4	96,000
5	92,000
6	87,000
7	83,000
8	81,000
9	79,000
10	77,000
11-20	66,000
21-30	62,000
31-40	58,000
41-60	55,000
Over 60	50,000

**Note:**

In extreme climate areas, additional capacities shall be considered.

and Refrigeration Field Service. Copper tubing (unless tin-lined) shall not be used if the gas contains more than an average of 0.3 grains of hydrogen sulfide per 100 standard feet<sup>3</sup> of gas.

**E 35.2 Protection Coatings for Metal Gas Piping.** All buried or submerged metallic gas piping shall be protected from corrosion by approved coatings or wrapping materials. All gas pipe protective coatings shall be approved types, shall be machine applied, and shall conform to recognized standards. Field wrapping shall provide equivalent protection and is restricted to those short sections and fittings that are necessarily stripped for threading or welding. Risers shall be coated or wrapped to a point at least 6 inches (152 mm) above ground.

**E 35.3 Plastic.** Plastic piping shall be used underground only and shall meet the requirements of ASTM D 2513, Thermoplastic Gas Pressure Pipe, Tubing, and Fittings, or ASTM D 2517, Reinforced Epoxy Resin Gas Pressure Pipe and Fittings, as well as the design pressure and design limitations of 49 CFR 192.123, and shall otherwise conform to the installation requirements thereof.

### **E 36 Gas Piping Installations.**

#### **E 36.1 Minimum Burial Below Ground Level and Clearances.**

All gas piping installed below ground level shall have a minimum earth cover of 18 inches (451 mm) and shall be installed with at least 12 inches (305 mm) of clearance in any direction from any other underground utility system.

#### **E 36.2 Metallic Gas Piping.**

**E 36.2.1** All metallic gas piping systems shall be installed in accordance with approved plans and specifications, including provisions for cathodic protection. Each cathodic protection system shall be designed and installed to conform to the provisions of 49 CFR 192.

**E 36.2.2** Where the cathodic protection system is designed to protect only the gas piping system, the gas piping system shall be electrically isolated from all other underground metallic systems or installations. Where only the gas piping system is cathodically protected against corrosion, a dielectric fitting shall be used in the M/H gas connection to insulate the M/H from the underground gas piping system.

**E 36.2.3** Where a cathodic protection system is designed to provide all underground

metallic systems and installations with protection against corrosion, all such systems and installations shall be electrically bonded together and protected as a whole.

**E 36.3 Plastic Gas Piping.** Plastic gas piping shall only be used underground and shall be installed with an electrically conductive wire for locating the pipe. The wire used to locate the plastic pipe shall be copper, not smaller in size than No. 18 AWG, with insulation approved for direct burial. Every portion of a plastic gas piping system consisting of metallic pipe shall be cathodically protected against corrosion.

**E 36.4 Gas Piping System Shutoff Valve.** A readily accessible and identifiable shutoff valve controlling the flow of gas to the entire M/H community gas piping system shall be installed near the point of connection to the service piping or to the supply connection of an LPG container.

### **E 37 Liquefied Petroleum Gas Equipment.**

LPG equipment shall be installed in accordance with the applicable provisions of NFPA 58, *Liquefied Petroleum Gas Code*.

### **E 38 Oil Supply.**

The following three methods of supplying oil to an individual M/H site shall be permitted:

- (1) Supply from an outside underground tank (see Section 2.4.6)
- (2) Supply from a centralized oil distribution system designed and installed in accordance with accepted engineering practices and in compliance with NFPA 31, *Standard for the Installation of Oil-Burning Equipment*
- (3) Supply from an outside aboveground tank (see Section 2.4.6)

**E 38.1 Minimum Oil Supply Tank Size.** Oil supply tanks shall have a minimum capacity equal to 20 percent of the average annual oil consumption.

**E 38.2 Oil Supply Connections – General.** Oil supply connections at M/H stands, where provided from a centralized oil distribution system, shall be located and arranged to permit attachment in a work-like manner to a manufactured home utilizing the stand. The installation of such facilities shall meet the provisions of NFPA 31, *Standard for the Installation of Oil-Burning Equipment*, and particularly Section 3.8 thereof.

### **E 39 Fuel Supply Systems Installation.**

**E 39.1 Flexible Gas Connector.** Each gas supply connector shall be listed for outside M/H use, shall be not more than 6 ft (1.83 m) in

length, and shall have a capacity rating adequate to supply the connected load.

**Exception:** All gas supply connections for manufactured homes located on an all-weather wood, concrete, or concrete block foundation system or on a foundation constructed in accordance with the local building code or, in the absence of a local code, with a recognized model building code.

**E 39.2 Use of Approved Pipe and Fittings of Extension.** Where it is necessary to extend the M/H inlet to permit connection of the 6 foot (1.83 m) listed connector to the site gas outlet, the extension shall be of approved materials of the same size as the M/H inlet and shall be adequately supported at no more than 4 foot (1.22 m) intervals to the M/H.

**E 39.3 Mechanical Protection.** All gas outlet risers, regulators, meters, valves, or other exposed equipment shall be protected against accidental damage.

**E 39.4 Special Rules on Atmospherically Controlled Regulators.** Atmospherically controlled regulators shall be installed in such a manner that moisture cannot enter the regulator vent and accumulate above the diaphragm. Where the regulator vent is obstructed due to snow and icing conditions, shields, hoods, or other suitable devices shall be provided to guard against closing of the vent opening.

**E 39.5 Fuel Gas Piping Test.** The M/H fuel gas piping system shall be tested only with air before it is connected to the gas supply. The M/H gas piping system shall be subjected to a pressure test with all appliance shutoff valves in their closed positions.

**E 39.5.1** The fuel gas piping test shall consist of air pressure at not less than 10 inch water column or more than 14 in. water column [6 oz/in.<sup>2</sup> to 8 oz/in.<sup>2</sup> (2490 Pa to 3486 Pa)]. The system shall be isolated from the air pressure source and shall maintain this pressure for 10 minutes or more without perceptible leakage. Upon satisfactory completion of the test, the appliance valves shall be opened, and the gas appliance connectors shall be tested with soapy water or bubble solution while under the pressure remaining in the piping system. Solutions used for testing for leakage shall not contain corrosive chemicals. Pressure shall be measured with either a manometer, slope gauge, or gauge that is calibrated in either water in. or psi with increments of either

1/10 inch (2.5 mm) or 1/10 psi (0.6 kPa gauge), as applicable. Upon satisfactory completion of the test, the M/H gas supply connector shall be installed, and the connections shall be tested with soapy water or bubble solution.

#### WARNING

Do not overpressurize the fuel gas piping system. Damage to valves, regulators, and appliances can occur due to pressurization beyond the maximums specified.

**E 39.5.2** Gas appliance vents shall be visually inspected to ensure that they have not been dislodged in transit and are connected securely to the appliance.

#### E 39.6 Oil Tanks.

No more than one 660 gallon (2500 L) tank or two tanks with aggregate capacity of 660 gallon (2500 L) or less shall be connected to one oil-burning appliance. Two supply tanks, where used, shall be cross-connected and provided with a single fill and single vent as described in NFPA 31, *Standard for the Installation of Oil-Burning Equipment*, and shall be on a common slab and rigidly secured one to the other. Tanks having a capacity of 660 gallon (2500 L) or less shall be securely supported by rigid, noncombustible supports to prevent settling, sliding, or lifting.

**E 39.6.1** Oil supply tanks shall be installed in accordance with the applicable provisions of NFPA 31, *Standard for the Installation of Oil-Burning Equipment*.

**E 39.6.2** A tank with a capacity no larger than 60 gallon (230 L) shall be permitted to be a DOT-5 shipping container (drum) and so marked, or a tank meeting the provisions of UL 80, *Steel Inside Tank for Oil Burner Fuel*. Tanks other than DOT-5 shipping containers having a capacity of not more than 660 gallon (2500 L) shall meet the provisions of UL 80. Pressure tanks shall be built in accordance with Section VIII, *Pressure Vessels, ASME Boiler, and Pressure Vessel Code*.

**E 39.6.3** Tanks, as described in Sections 2.4.6 and 2.4.6.2, that are adjacent to buildings shall be located not less than 10 feet (3.05 m) from a property line that is permitted to be built upon.

**E 39.6.4** Tanks with a capacity no larger than 660 gallon (2500 L) shall be equipped with an open vent no smaller than 1.5-in.



(38 mm) iron pipe size; tanks with a 500 gallon (1900 L) or less capacity shall have a vent of 1.25 inch (32 mm) iron pipe size.

**E 39.6.5** Tanks shall be provided with a means of determining the liquid level.

**E 39.6.6** The fill opening shall be a size and in a location that permits ready filling without spillage.

#### **E 40 Manufactured Home Accessory Building Fuel Supply Systems.**

Fuel gas supply systems installed in a M/H accessory building or structure shall comply with the applicable provisions of NFPA 54, *National Fuel Gas Code*, and NFPA 58, *Liquefied Petroleum Gas Code*. Fuel oil supply systems shall comply with the applicable provisions of NFPA 31, *Standard for the Installation of Oil-Burning Equipment*.

#### **E 41 Community Building Fuel Supply Systems in Manufactured Home Communities.**

##### **E 41.1 Fuel Gas Piping and Equipment Installations.**

Fuel gas piping and equipment installed within a permanent building in a M/H community shall comply with nationally recognized appliance and fuel gas piping codes and standards adopted by the Authority Having Jurisdiction. Where the state or other political subdivision does not assume jurisdiction, such fuel gas piping and equipment installations shall be designed and installed in accordance with the appropriate provisions of NFPA 54, *National Fuel Gas Code*, or NFPA 58, *Liquefied Petroleum Gas Code*.

##### **E 41.2 Oil Supply Systems in M/H Communities.**

Oil-burning equipment and installation within an M/H community shall be designed and constructed in accordance with the applicable codes and standards adopted by the Authority Having Jurisdiction. Where the state or other political subdivision does not assume jurisdiction, such installation shall be designed and constructed in accordance with the applicable provisions of NFPA 31, *Standard for the Installation of Oil-Burning Equipment*.

##### **E 41.3 Oil-Burning Equipment and Installation.**

Oil-burning equipment and installation within a building constructed in an M/H community in accordance with the local building code or a nationally recognized building code shall comply with nationally recognized codes and standards adopted by the Authority Having Jurisdiction. Where the state or other political subdivision does not assume jurisdiction, such

oil-burning equipment and installation shall be designed and installed in accordance with the appropriate provisions of NFPA 31, *Standard for the Installation of Oil-Burning Equipment*.

#### **E 41.4 Inspections and Tests.**

Inspections and tests for fuel gas piping shall be made in accordance with Chapters 1 and 12.

### **Part E**

#### **Recreational Vehicle Parks Definitions and General Requirements**

##### **E 42 Recreational Vehicle (RV).**

A vehicular-type unit primarily designed as temporary living quarters for recreational, camping, travel, or seasonal use, that either has its own motive power, or is mounted on or towed by another vehicle. The basic entities are camping trailer, fifth-wheel trailer, motor home, park trailer, travel trailer, and truck camper.

##### **E 43 Recreational Vehicle Park.**

A plot of land upon which two (2) or more recreational vehicle sites are located, established, or maintained for occupancy by recreational vehicles of the general public as temporary living quarters for recreation or vacation purpose.

##### **E 44 Recreational Vehicle Site**

Within a recreational vehicle park, a plot of ground intended for the accommodation of a recreational vehicle, a tent, or other individual camping unit on a temporary basis.

##### **E 45 General.**

All plumbing shall be installed in accordance with the plumbing codes of the Authority Having Jurisdiction and with this appendix.

### **Part F**

#### **Recreational Vehicle Park Toilet and Shower Facilities**

**E 46** Toilets and urinals shall be provided at one (1) or more locations in every recreational vehicle park. They shall be convenient of access and shall be located within a five hundred (500) foot (152.4 m) radius from any recreational vehicle site not provided with an individual sewer connection.

**E 47** Facilities for males and females shall be appropriately marked.

**E 48** A minimum of one (1) toilet shall be provided for each sex up to the first twenty-five (25) sites. For each additional twenty-five (25) sites not provided with sewer connections, an additional toilet shall be provided.

**E 49** The interior finish of walls shall be moisture resistant to a height of four (4) feet (1219 mm) to facilitate washing and cleaning.

**E 50** The floors shall be constructed of material impervious to water and shall be easily cleanable. Any toilet building having water-flush toilets shall be provided with a floor drain in the toilet room. This drain shall be provided with means to protect the trap seal as required by this code.

**E 51** If water-flush toilets are provided, an equal number of lavatories shall be provided for up to six (6) toilets. One additional lavatory shall be provided for each two (2) toilets when more than six (6) toilets are required. Each lavatory basin shall have a piped supply of potable water and shall drain into the drainage system.

**E 52** If separate facilities are provided for men and women, urinals shall be acceptable for no more than one-third (1/3) of the toilets required in the men's facilities, except that one (1) urinal may be used to replace a toilet in a minimum park. Only individual stall or wall hung types of urinals shall be installed. Floor-type trough units shall be prohibited.

**E 53** Toilets shall be of an approved, elongated bowl type and shall be provided with seats with open fronts.

**E 54** Each toilet shall be in a separate compartment and be provided with a door with a latch for privacy and a holder or dispenser for toilet paper. Dividing walls or partitions shall be at least five (5) feet (1524 mm) high and shall be separated from the floor by a space not greater than twelve (12) inches (305 mm).

**E 55** Toilet compartments shall be not less than thirty (30) inches (762 mm) in width (no toilet shall be set closer than fifteen (15) inches (381 mm) from its center to a side wall) and there shall be not less than thirty (30) inches (762 mm) of clear space in front of each toilet.

**E 56** Each toilet room for women shall be provided with a receptacle for sanitary napkins. The receptacle shall be of durable, impervious, and readily cleanable material, and shall be provided with a lid.

**E 57** Each shower, if provided, shall have a floor area of thirty-six (36) inches by thirty-six (36) inches (914 mm x 914 mm) and shall be capable of encompassing a thirty (30) inch (762 mm) diameter circle and shall be of the individual type, and each shower area shall be visually screened from view, with a minimum floor area of thirty-six (36) by thirty-six (36) inches (914 mm x 914 mm) per shower. Each shall be provided with individual dressing areas screened from view and shall contain a minimum of one (1) clothing hook and stool (or equivalent bench area).

**E 58** Each shower area shall be designed to minimize the flow of water into the dressing area and shall be connected to the drainage system by means of a properly vented and trapped inlet. Each such area shall have an impervious, skid-resistant surface; wooden racks (duck boards) over shower floors shall be prohibited.

**E 59** Every toilet building shall have a minimum ceiling height of seven (7) feet (2134 mm) and unless artificial light is provided, a window or skylight area equal to at least ten (10) percent of the floor area shall be provided.

All doors to the exterior shall open outward, be self-closing, and shall be visually screened by means of a vestibule or wall to prevent direct view of the interior when the exterior doors are open. Such screening shall not be required on single toilet units.

**E 60** Every toilet room shall have permanent, non-closable, screened opening(s), having a total area not less than five (5) percent of the floor area and opening directly to the exterior in order to provide proper ventilation. Listed exhaust fan(s), vented to the exterior, the rating of which in cubic feet per minute is at least twenty-five (25) percent of the total volume of the room(s) served, shall be considered as meeting the requirements of this subsection. All openable windows and vents to the outside shall be provided with fly-proof screens of not less than number sixteen (16) mesh.

### Part G

#### Recreational Vehicle Park Potable Water Supply and Distribution

##### E 61 Quality.

The supply or supplies of water shall comply with the appropriate potable water standards of the state or local health authority or, in the absence thereof, with the Drinking Water Standard of the Federal Environmental Protection Agency. (See 42 CFR Part 72, subpart J.)

##### E 62 Sources.

Only water approved by a regulating agency shall be acceptable. Where an approved public water supply system is available, it shall be used. Where the park has its own water supply system, the components of the system shall be approved. A water supply system which is used on a seasonal basis shall be provided with means for draining.

##### E 63 Prohibited Connections.

The potable water supply shall not be connected to any non-potable or unapproved water supply, nor be subjected to any backflow or back-siphonage.

**E 64 Supply.**

The water supply system shall be designed and constructed in accordance with the following:

- (A) A minimum of twenty-five (25) gallons (94.6 L) per day per site for sites without individual water connections.
- (B) A minimum of fifty (50) gallons (189.3 L) per day per site for sites with individual water connections.
- (C) A minimum of fifty (50) gallons (189.3 L) per day per site if water-flush toilets are provided in rest rooms.

**E 65 Pressure and Volume.**

Where water is distributed under pressure to any individual site, the water supply system shall be designed to provide a minimum flow pressure of twenty (20) pounds per square inch (137.8 kPa) with a minimum flow of two (2) gallons (7.6 L) per minute at any outlet. The maximum pressure shall not exceed eighty (80) pounds per square inch (551 kPa).

**E 66 Outlets.**

Water outlets shall be convenient to access and, when not piped to individual RV sites, shall not be located farther than three hundred (300) feet (91.4 m) from any site. Provisions shall be made to prevent accumulation of standing water or the creation of muddy conditions at each water outlet.

**E 67 Storage Tanks.**

Water storage tanks shall be constructed of impervious materials, protected against contamination, and provided with locked, watertight covers. Any overflow or ventilation openings shall be down facing and provided with corrosion-resistant screening of not less than number twenty-four (24) mesh to prevent the entrance of insects and vermin. Water storage tanks shall not have direct connections to sewers.

**Part H**

**Recreational Vehicle Park Water Connections for Individual Recreational Vehicles**

**E 68** When provided, the water connections for potable water to individual recreational vehicle sites shall be located on the left rear half of the site (left side of RV) within four (4) feet (1219 mm) of the stand.

**E 69** Each potable water connection shall consist of a water riser pipe which shall be equipped with a threaded male spigot located at least twelve (12) inches (305 mm) but not more than twenty-four (24) inches (610 mm) above grade level for the attachment of a standard water hose. The water riser pipe shall be protected from physical damage per

this code. This connection shall be equipped with a listed anti-siphon backflow prevention device.

**E 70 Drinking Fountains.**

If provided, drinking fountains shall be in conformance with the requirements of this code.

**Part I**

**Recreational Vehicle Park Drainage System**

**E 71** An adequate and approved drainage system shall be provided in all RV parks for conveying and disposing of all sewage. Where available, parks shall be connected to a public sewer system.

**E 72 Material.**

Pipe and fittings installed in the drainage system shall be of material listed and approved and installed per this code.

**E 73** The minimum diameters of drainage laterals, branches, and mains serving RV sites shall be in accordance with the following table:

**Table E-4**

Maximum Number of Recreational Vehicle Stands Served	Minimum Pipe Sizes	
	Inches (ID)	Nominal (mm)
5	3	76
36	4	102
71	5	127
120	6	152
440	8	203

**E 74** The sewer lines shall be located to prevent damage from vehicular traffic.

**E 75** Cleanouts shall be provided per Chapter 7 of this code.

**Part J**

**Recreational Vehicle Site Drainage System Inlet**

**E 76** When provided, the site drainage system inlet connections for individual RVs shall be located so as to prevent damage by the parking of RVs or automobiles and shall consist of a sewer riser extending vertically to grade. The minimum diameter of the sewer riser pipe shall be three (3) inches (76 mm), and it shall be provided with a four (4) inch (102 mm) inlet or a minimum three (3) inch (76 mm) female fitting.

**E 77** When provided, the sewer inlet to individual RV sites shall be located on the left rear half of the site (left side of the RV) within four (4) feet (1219 mm) of the stand.

**E 78** The sewer riser pipe shall be firmly imbedded in the ground and protected against damage from movement. It shall be provided with a tight-fitting plug or cap which shall be secured by a durable chain (or equivalent) to prevent loss.

### Part K

#### Recreational Vehicle Park Sanitary Disposal Stations

**E 79** One (1) RV sanitary disposal station shall be provided for each one hundred (100) RV sites, or part thereof, which are not equipped with individual drainage system connections.

**E 80** Each station shall be level and convenient of access from the service road and shall provide easy ingress and egress for recreational vehicles.

#### **E 81 Construction.**

Unless other approved means are used, each station shall have a concrete slab with drainage system inlet located so as to be on the road (left) side of the recreational vehicle. The slab shall be not less than three (3) feet by three (3) feet (914 mm x 914 mm), at least three and one-half (3-1/2) inches (89 mm) thick and properly reinforced. The surface of which is troweled to a smooth finish and sloped from each side inward to a drainage system inlet.

The drainage system inlet shall consist of a four (4) inch (102 mm) self-closing, foot-operated hatch of approved material with cover milled to fit tight. The hatch body shall be set in the concrete of the slab with the lip of the opening flush with its surface to facilitate the cleansing of the slab with water. The hatch shall be properly connected to a drainage system inlet which shall discharge to an approved sanitary sewage disposal facility.

**E 82** Where the recreational vehicle park is provided with a piped water supply system, means for flushing the recreational vehicle holding tank and the sanitary disposal station slab shall be provided and shall consist of a piped supply of water under pressure, terminating in an outlet located and installed so as to prevent damage by automobiles or recreational vehicles. The flushing device shall consist of a properly supported riser terminating at least two (2) feet (610 mm) above the ground surface, with a three-fourth (3/4) inch (19.1 mm) valved outlet adaptable for a flexible hose.

The water supply to the flushing device shall be protected from backflow by means of a listed vacuum breaker or backflow prevention device located downstream from the last shutoff valve.

Adjacent to the flushing arrangement shall be posted a sign of durable material not less than two

(2) feet by two (2) feet (610 mm x 610 mm) in size. Inscribed thereon in clearly legible letters shall be the following:

**DANGER – NOT TO BE USED FOR DRINKING OR DOMESTIC PURPOSES.**

### Part L

#### Recreational Vehicle Park Water Supply Stations

**E 83** A potable watering station, if provided for filling recreational vehicle potable water tanks, shall be located at least fifty (50) feet (15,240 mm) from a sanitary disposal station. When such is provided, adjacent to the potable water outlet shall be posted a sign of durable material not less than two (2) feet by two (2) feet (610 mm by 610 mm) in size. Inscribed thereon in clear legible letters on a contrasting background shall be: **POTABLE WATER. NOT TO BE USED FOR FLUSHING WASTE TANKS.** The potable water shall be protected from backflow by means of a listed vacuum breaker located downstream from the last shutoff valve.

### Part M

#### Recreational Vehicle Park Fuel Gas Equipment and Installations

**E 84** All fuel gas equipment and installations shall comply with Part D of this appendix, except as otherwise permitted or required by this code.



# APPENDIX G

## GRAY WATER SYSTEMS FOR SINGLE-FAMILY DWELLINGS

### G 1 Gray water Systems – General.

- (A) The provisions of this appendix shall apply to the construction, alteration, and repair of gray water systems for underground landscape irrigation. Installations shall be allowed only in single-family dwellings. The system shall have no connection to any potable water system and shall not result in any surfacing of the gray water. Except as otherwise provided for in this appendix, the provisions of this code shall be applicable to gray water installation.
- (B) The type of system shall be determined on the basis of location, soil type, and groundwater level, and shall be designed to accept all gray water connected to the system from the residential building. The system, except as otherwise approved, shall consist of a holding tank or tanks which discharge into subsurface irrigation/disposal fields.
- (C) No gray water system or part thereof shall be located on any lot other than the lot which is the site of the building or structure which discharges the gray water, nor shall any gray water system or part thereof be located at any point having less than the minimum distances indicated in Table G-1.
- (D) No permit for any gray water system shall be issued until a plot plan with appropriate data satisfactory to the Authority Having Jurisdiction has been submitted and approved. When there is insufficient lot area or inappropriate soil conditions for adequate absorption of the gray water, as determined by the Authority Having Jurisdiction, no gray water system shall be permitted.
- (E) No permit shall be issued for a gray water system on any property in a geologically sensitive area as determined by the Authority Having Jurisdiction.
- (F) Private sewage disposal systems existing or to be constructed on the premises shall comply with Appendix K of this code. In addition, appropriate clearances from the gray water systems shall be maintained as provided in Table G-1. The capacity of the private sewage disposal system, including required future areas, shall not be decreased or otherwise affected by the existence or proposed installation of a gray water system servicing the premises.

### G 2 Definition.

Gray water is untreated household waste water which has not come into contact with toilet waste.

Gray water includes used water from bathtubs, showers, bathroom wash basins, and water from clothes-washer and laundry tubs. It shall not include wastewater from kitchen sinks or dishwashers.

### G 3 Permit.

It shall be unlawful for any person to construct, install, or alter, or cause to be constructed, installed, or altered any gray water system in a building or on a premises without first obtaining a permit to do such work from the Authority Having Jurisdiction.

### G 4 Drawings and Specifications.

The Authority Having Jurisdiction may require any or all of the following information to be included with or in the plot plan before a permit is issued for a gray water system or at any time during the construction thereof:

- (A) Plot plan drawn to scale completely dimensioned, showing lot lines and structures, direction and approximate slope of surface, location of all present or proposed retaining walls, drainage channels, water supply lines, wells, paved areas and structures on the plot, number of bedrooms and plumbing fixtures in each structure, location of private sewage disposal system and 100 percent expansion area or building sewer connecting to the public sewer, and location of the proposed gray water system.
- (B) Details of construction necessary to assure compliance with the requirements of this appendix, together with a full description of the complete installation, including installation methods, construction, and materials as required by the Authority Having Jurisdiction.
- (C) A log of soil formations and groundwater level as determined by test holes dug in proximity to any proposed irrigation area, together with a statement of water absorption characteristics of the soil at the proposed site as determined by approved percolation tests.

**Exception:** The Authority Having Jurisdiction may allow the use of Table G-2 in lieu of percolation tests.

### G 5 Inspection and Testing.

#### (A) Inspection.

- (1) All applicable provisions of this appendix

and of Section 103.5 of this code shall be complied with.

- (2) System components shall be properly identified as to manufacturer.
- (3) Holding tanks shall be installed on dry, level, well-compacted soil if underground or on a level three (3) inch (76 mm) concrete slab if above ground.
- (4) Holding tanks shall be anchored against overturning.
- (5) If a design is predicated on soil tests, the irrigation/disposal field shall be installed at the same location and depth as the tested area.
- (6) Installation shall conform with the equipment and installation methods identified in the approved plans.

**(B) Testing.**

- (1) Holding tanks shall be filled with water to the overflow line prior to and during inspection. All seams and joints shall be left exposed, and the tank shall remain watertight.
- (2) A flow test shall be performed through the system to the point of gray water irrigation/disposal. All lines and components shall be watertight.

**G 6 Procedure for Estimating Gray water Discharge.**

**(A)** The number of occupants of each dwelling unit shall be calculated as follows:

First bedroom	2
Each additional bedroom	1

**(B)** The estimated gray water flows for each occupant shall be calculated as follows:

Showers, bathtubs, and washbasins	25 GPD (95LPD)
Laundry	15 GPD (57 LPD)

**(C)** The total number of occupants shall be multiplied by the applicable estimated gray water discharge as provided above, and the type of fixtures connected to the gray water system.

**Example 1:**

Single-family dwelling; 3 bedrooms with showers, bathtubs, washbasins; and laundry facilities all

connected to the gray water system:

Total number of occupants = 2 + 1 + 1 = 4

Estimated gray water flow = 4 x (25 + 15) = 160 GPD  
 (metric) = 4 x (95 + 57) = 608 LPD

**Example 2:**

Single-family dwelling; 4 bedrooms with only the clothes washer connected to the gray water system:

Total number of occupants = 2 + 1 + 1 + 1 = 5

Estimated gray water flow = 5 x 15 = 75 GPD  
 (metric) = 5 x 57 = 285 LPD

**G7 Required Area of Subsurface Irrigation/ Disposal Fields (See Figure G-5.)**

Each valved zone shall have a minimum effective irrigation area in square feet as determined by Table G-2 for the type of soil found in the excavation, based upon a calculation of estimated gray water discharge pursuant to Section G 6 of this appendix, or the size of the holding tank, whichever is larger. The area of the irrigation/disposal field shall be equal to the aggregate length of the perforated pipe sections within the valved zone multiplied the width of the proposed irrigation/disposal field. Each proposed gray water system shall include at least three (3) valved zones, and each zone shall be in compliance with the provisions of the section. No excavation for an irrigation/disposal field shall extend within five (5) vertical feet of highest known seasonal groundwater, nor to a depth where gray water may contaminate the groundwater or ocean water. The applicant shall supply evidence of groundwater depth to the satisfaction of the Authority Having Jurisdiction.

**G 8 Determination of Maximum Absorption Capacity.**

**(A)** Wherever practicable, irrigation/disposal field size shall be computed from Table G-2.

**(B)** In order to determine the absorption quantities of questionable soils other than those listed in Table G-2, the proposed site may be subjected to percolation tests acceptable to the Authority Having Jurisdiction.

**(C)** When a percolation test is required, no gray water system shall be permitted if the test shows the absorption capacity of the soil is less than eighty-three hundredths (0.83) gallons per square foot (33.8 L/m<sup>2</sup>) or more than five and twelve hundredths (5.12) gallons per square foot

(208.5 L/m<sup>2</sup>) of leaching area per twenty-four (24) hours.

**G 9 Holding Tank Construction. (See Figures G-1, G-2, G-3 and G-4.)**

- (A) Plans for all holding tanks shall be submitted to the Authority Having Jurisdiction for approval. Such plans shall show all dimensions, structural calculations, bracings, and such other pertinent data as may be required. A minimum capacity of fifty (50) gallons (189 L) is required.
- (B) Holding tanks shall be constructed of solid, durable materials not subject to excessive corrosion or decay and shall be watertight.
- (C) Each holding tank shall be vented as required by Chapter 9 of this code and shall have a locking, gasketed access opening or approved equivalent to allow for inspection and cleaning.
- (D) Each holding tank shall have its rated capacity permanently marked on the unit. In addition, a sign GRAYWATER IRRIGATION SYSTEM, DANGER — UNSAFE WATER shall be permanently marked on the holding tank.
- (E) Each holding tank installed above ground shall have an emergency drain separate from that connecting the tank with the irrigation/disposal fields and an overflow drain. The emergency and overflow drains shall have permanent connections to the building drain or building sewer, upstream of septic tanks, if any. The overflow drain shall not be equipped with a shutoff valve.
- (F) The overflow and emergency drainpipes shall not be less in size than the inlet pipe. The vent size shall be determined based on the total gray water fixture units as outlined in Table 7-5 of this code. Unions or equally effective fittings shall be provided for all piping connected to the holding tank.
- (G) Each holding tank shall be structurally designed to withstand all anticipated earth or other loads. All holding tank covers shall be capable of supporting an earth load of not less than three hundred (300) pounds per square foot (1464.6 kg/m<sup>2</sup>) when the tank is designed for underground installation.
- (H) If a holding tank is installed under ground, the system must be designed so that the tank overflow will gravity drain to the existing sewer line or septic tank. The tank shall be protected against sewer line backflow by a backwater valve.
- (I) **Materials.**
  - (1) Holding tanks shall be steel, protected from corrosion, both externally and internally by an approved coating or other acceptable means; shall meet nationally recog-

nized standards for the intended use; and shall be approved by the Authority Having Jurisdiction.

- (2) Holding tanks constructed of alternate material may be approved by the Authority Having Jurisdiction provided they comply with approved applicable standards.

**G 10 Valves and Piping. (See Figures G-1, G-2, G-3, and G-4.)**

Graywater piping discharging into the holding tank or having a direct connection to the sanitary drain or sewer piping shall be downstream of an approved waterseal type trap(s). If no such trap(s) exists, an approved vented running trap shall be installed upstream of the connection to protect the building from any possible waste or sewer gases. All gray water piping shall be marked or have a continuous tape marked with the words DANGER — UNSAFE WATER. All valves, including the three-way valve, shall be readily accessible and approved by the Authority Having Jurisdiction. A backwater valve installed pursuant to this code shall be provided on all holding tank drain connections to the sanitary drain or sewer piping.

**G 11 Irrigation/Disposal Field Construction. (See Figure G-5.)**

- (A) Perforated sections shall be a minimum three (3) inch (80 mm) diameter and shall be constructed of perforated high-density polyethylene pipe, perforated ABS pipe, perforated PVC pipe, or other approved materials provided that sufficient openings are available for distribution of the gray water into the trench area. Material, construction, and perforation of the pipe shall be in compliance with the appropriate absorption fields drainage piping standards and shall be approved by the Authority Having Jurisdiction.
- (B) Filter material, clean stone, gravel, slag, or similar filter material acceptable to the Authority Having Jurisdiction, varying in size from three-quarter (3/4) inch (20 mm) to two and one-half (2-1/2) inch (65 mm) shall be placed in the trench to the depth and grade required by this section. The perforated section shall be laid on the filter material in an approved manner. The perforated section shall then be covered with filter material to the minimum depth required by this section. The filter material shall then be covered with untreated building paper, straw, or similar porous material to prevent closure of voids with earth backfill. No earth backfill shall be placed over the filter material cover until after inspection and acceptance.



(C) Irrigation/disposal fields shall be constructed as follows:

(See chart on following page)

(D) When necessary on sloping ground to prevent excessive line slopes, irrigation/disposal lines shall be stepped. The lines between each horizontal leaching section shall be made with approved watertight joints and installed on natural or unfilled ground.

**G 12 Special Provisions**

(A) Other collection and distribution systems may be approved by the local Authority Having Jurisdiction, as allowed by Section 301.0 of this code.

(B) Nothing contained in this appendix shall be construed to prevent the Authority Having Jurisdiction from requiring compliance with higher requirements than those contained herein, where such higher requirements are essential to maintain a

	Minimum	Maximum
Number of drain lines per valved zone	1	—
Length of each perforated line	—	100 ft. (30,840 mm)
Bottom width of trench	12 in. (305 mm)	18 in. (457 mm)
Spacing of lines, center to center	4 ft. (1219 mm)	—
Depth of earth cover of lines	10 in. (254 mm)	—
Depth of filter material cover of lines	2 in. (51 mm)	—
Depth of filter material beneath lines	3 in. (76 mm)	—
Grade of perforated lines	level 3 in./100 ft.	2 mm/m

**TABLE G-1  
Location of Gray Water System**

Minimum Horizontal Distance in Clear Required From:	Holding Tank		Irrigation/ Disposal Field	
	Feet	(mm)	Feet	(mm)
Building structures <sup>1</sup>	5 <sup>2</sup>	(1,524 mm)	2 <sup>3</sup>	(610 mm)
Property line adjoining private property	5	(1,524 mm)	5	(1,524 mm)
Water supply wells <sup>4</sup>	50	(15,240 mm)	100	(30,480 mm)
Streams and lakes <sup>4</sup>	50	(15,240 mm)	50 <sup>5</sup>	(15,240 mm)
Sewage pits or cesspools	5	(1,524 mm)	5	(1,524 mm)
Disposal field and 100% expansion area	5	(1,524 mm)	4 <sup>6</sup>	(1,219 mm)
Septic tank	0	(0)	5	(1,524 mm)
On-site domestic water service line	5	(1,524 mm)	5	(1,524 mm)
Pressurized public water main	10	(3,048 mm)	10 <sup>7</sup>	(3,048 mm)

Note: When irrigation/disposal fields are installed in sloping ground, the minimum horizontal distance between any part of the distribution system and the ground surface shall be fifteen (15) feet (4572 mm).

<sup>1</sup> Including porches and steps, whether covered or uncovered, breezeways, roofed porte cocheres, roofed patios, carports, covered walks, covered driveways, and similar structures or appurtenances.

<sup>2</sup> The distance may be reduced to zero feet for aboveground tanks when first approved by the Authority Having Jurisdiction.

<sup>3</sup> Assumes a 45 degree (0.79 rad) angle from foundation.

<sup>4</sup> Where special hazards are involved, the distance required shall be increased as may be directed by the Authority Having Jurisdiction.

<sup>5</sup> These minimum clear horizontal distances shall also apply between the irrigation/disposal field and the ocean mean higher high tide line.

<sup>6</sup> Plus two (2) feet (610 mm) for each additional foot of depth in excess of one (1) foot (305 mm) below the bottom of the drain line.

<sup>7</sup> For parallel construction/for crossings, approval by the Authority Having Jurisdiction shall be required.

**TABLE G-2**  
**Design Criteria of Six Typical Soils**

<b>Type of Soil</b>	<b>Minimum square feet of irrigation/leaching area per 100 gallons of estimated gray water discharge per day</b>	<b>Maximum absorption capacity in gallons per square foot of irrigation/leaching area for a 24-hour period</b>
Coarse sand or gravel	20	5.0
Fine sand	25	4.0
Sandy loam	40	2.5
Sandy clay	60	1.7
Clay with considerable sand or gravel	90	1.1
Clay with small amounts of sand or gravel	120	0.8

**TABLE G-2**  
**(Metric) Design Criteria of Six Typical Soils**

<b>Type of Soil</b>	<b>Minimum square meters of irrigation/leaching area per liter of estimated gray water discharge per day</b>	<b>Maximum absorption capacity in liters per square meter of irrigation/leaching area for a 24-hour period</b>
Coarse sand or gravel	0.005	203.7
Fine sand	0.006	162.9
Sandy loam	0.010	101.8
Sandy clay	0.015	69.2
Clay with considerable sand or gravel	0.022	44.8
Clay with small amounts of sand or gravel	0.030	32.6

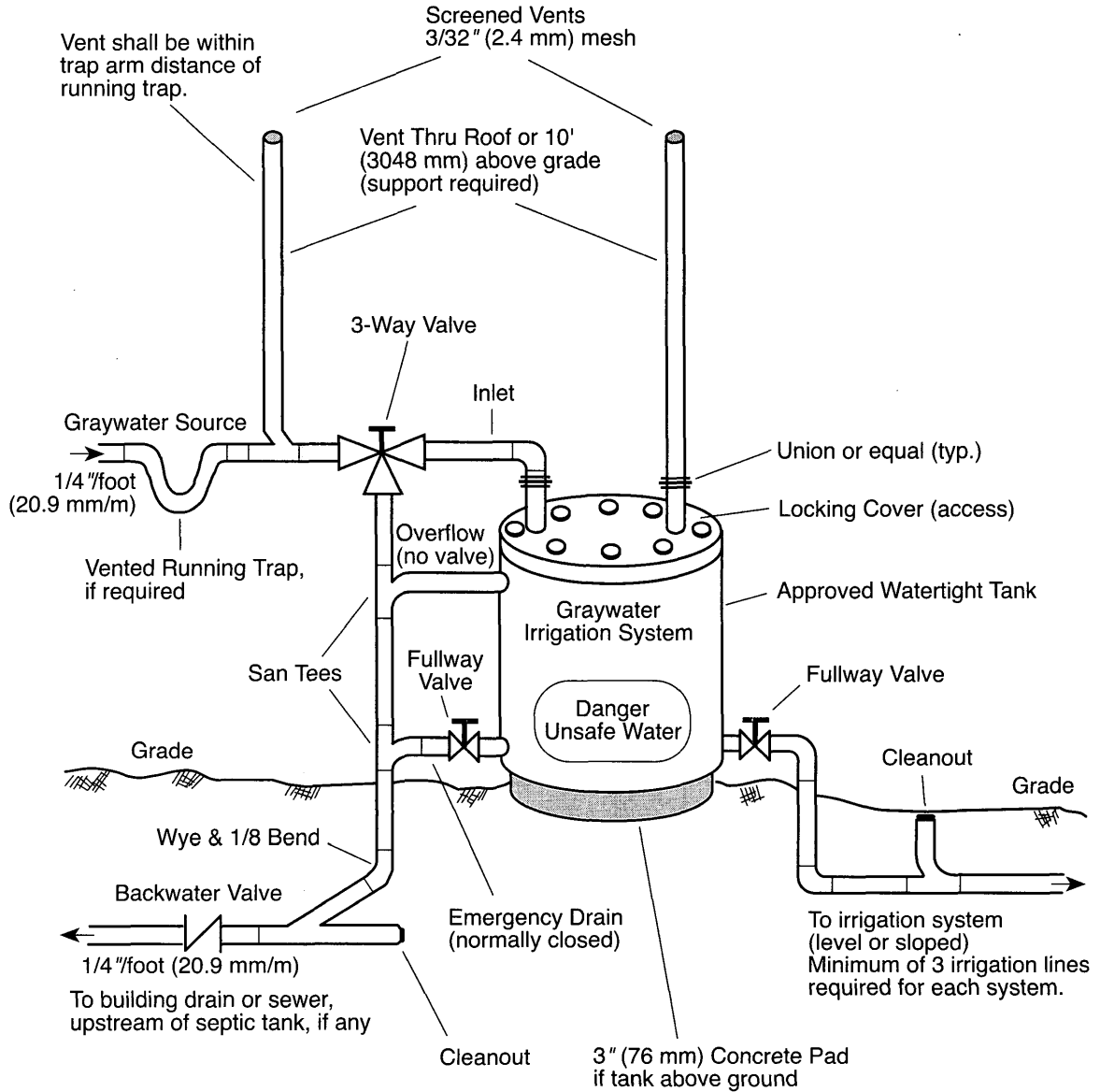

FIGURE G-1 Gray water System Tank – Gravity.

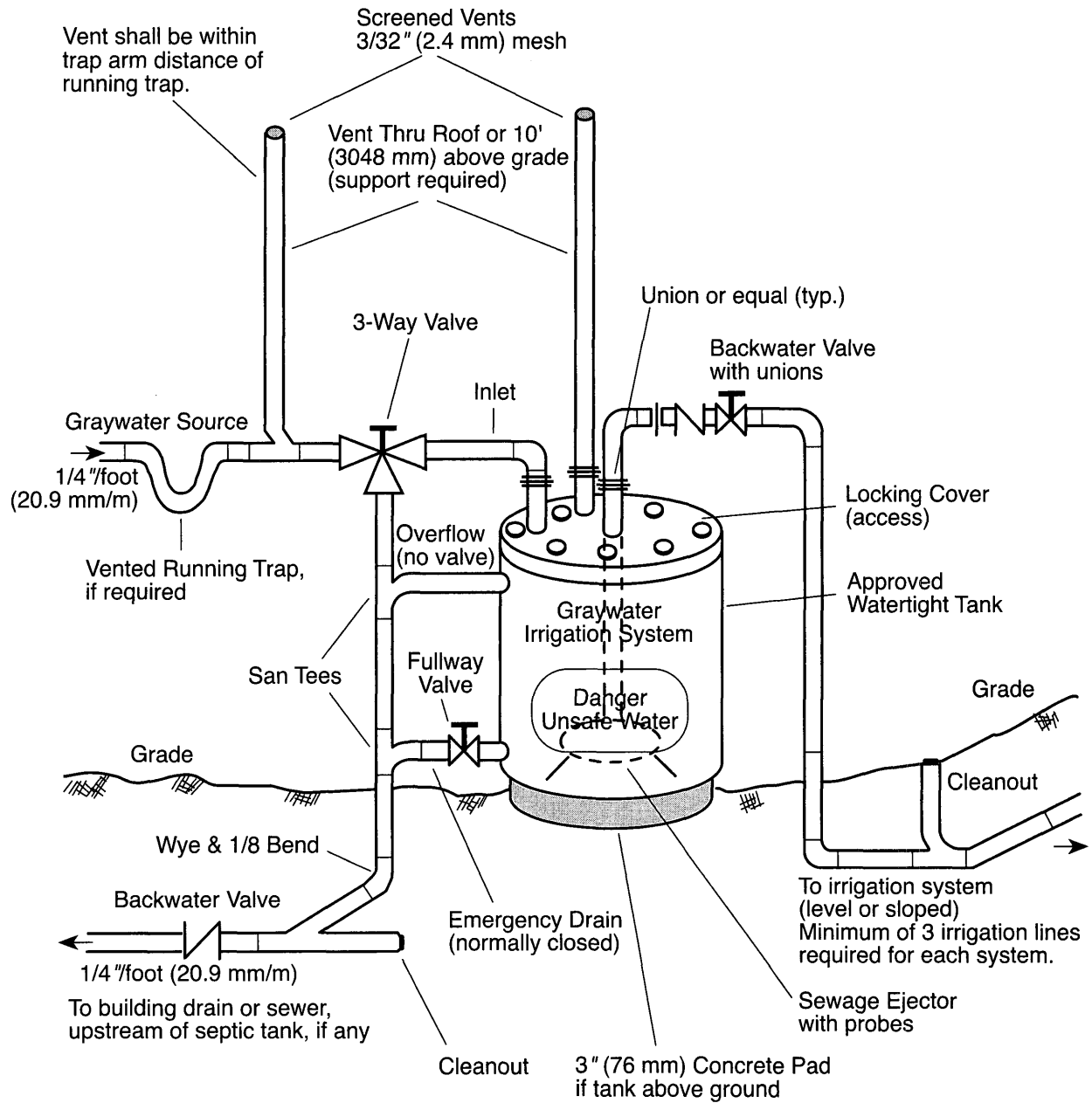

FIGURE G-2 Gray Water System Tank – Pumped.

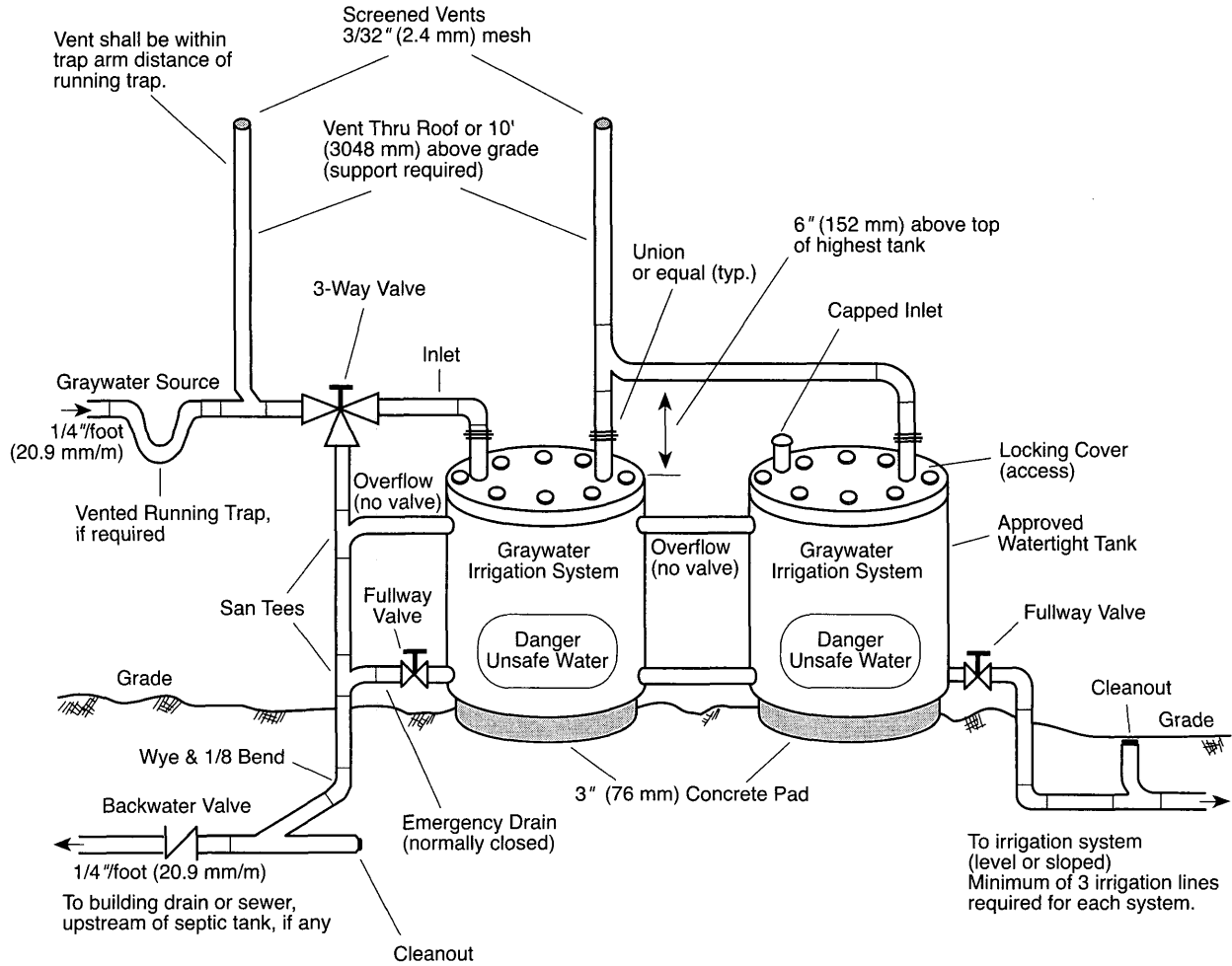

FIGURE G-3 Gray Water System Multiple-Tank Installation.

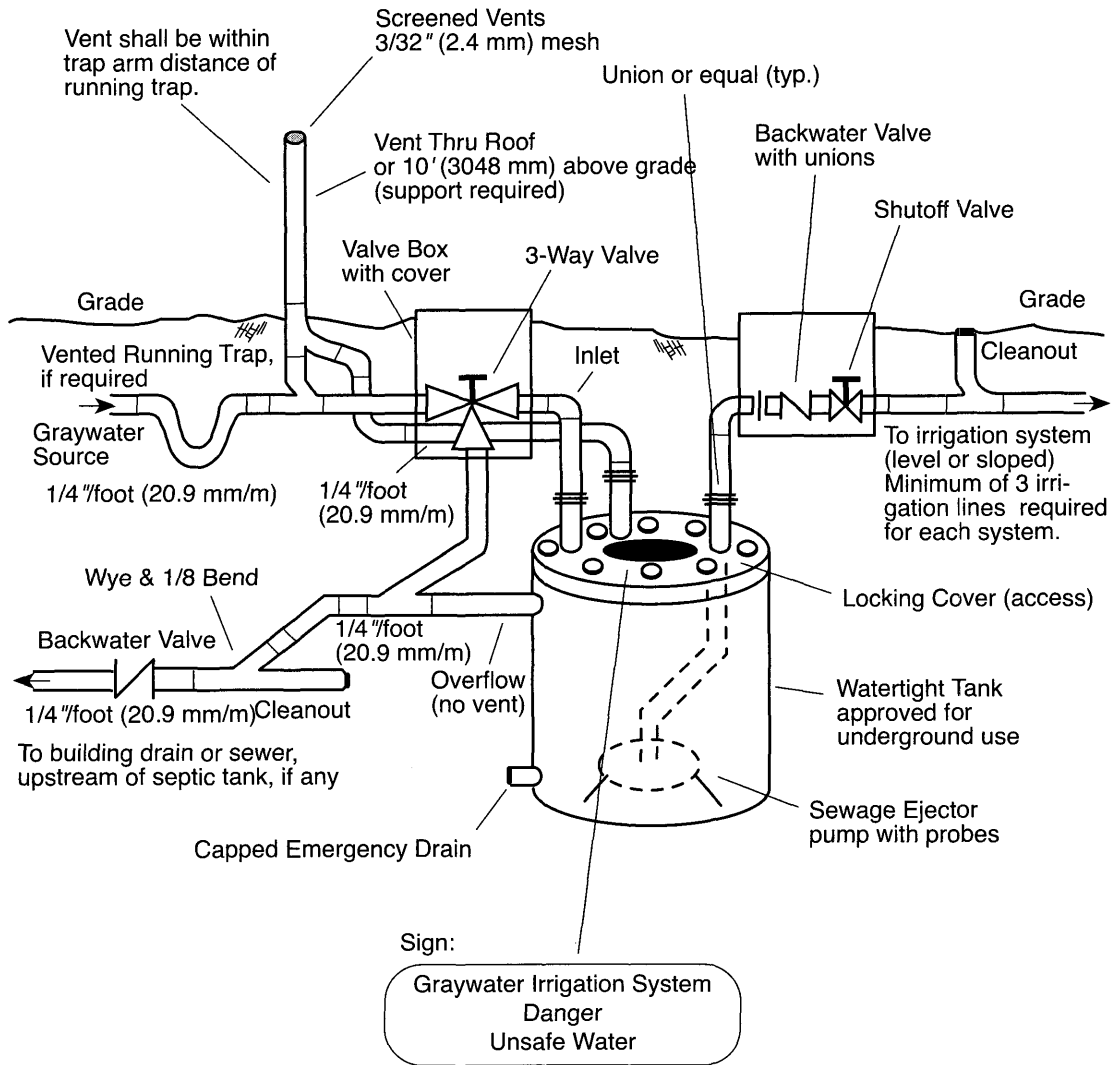
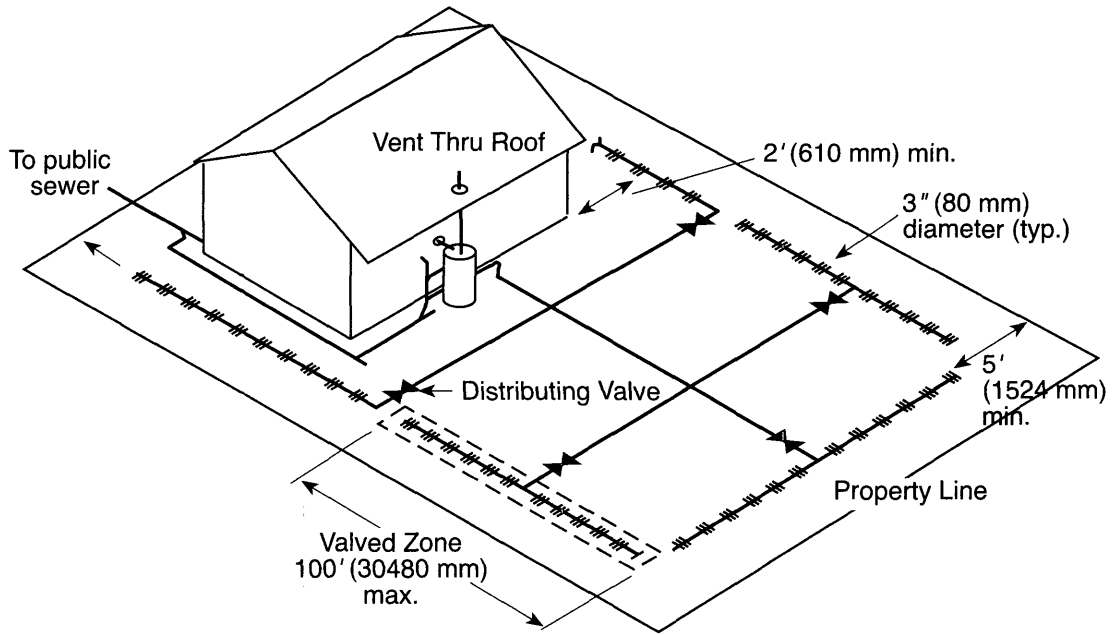

FIGURE G-4 Gray Water System Underground Tank – Pumped.



Note: Each valved zone shall have a minimum effective absorption/irrigation area in square feet predicated on the estimated graywater discharge in gallons per day and on the type of soil found in the area. The area of the field shall be equal to the aggregate length of perforated pipe sections within the valved zone times the width of the proposed field.

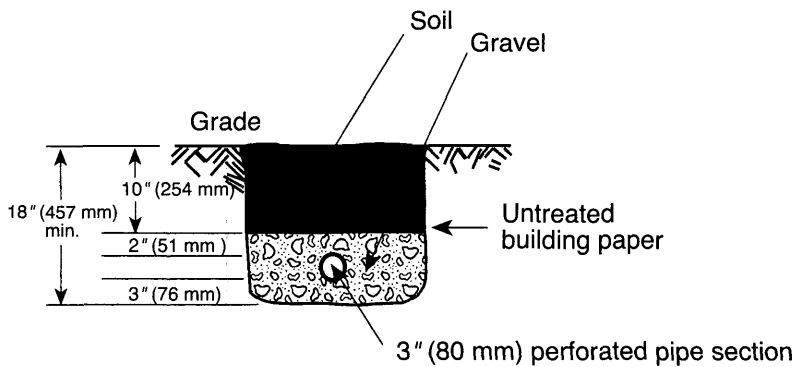

FIGURE G-5 Gray Water System Typical Irrigation Layout.

## APPENDIX H

### RECOMMENDED PROCEDURES FOR DESIGN, CONSTRUCTION, AND INSTALLATION OF COMMERCIAL KITCHEN GREASE INTERCEPTORS

#### H 101.0 General.

The provisions of this appendix shall apply to the design, construction, installation, and testing of commercial kitchen grease interceptors.

#### H 102.0 Waste Discharge Requirements.

**H 102.1** Waste discharge in establishments from fixtures and equipment which may contain grease, including but not limited to, scullery sinks, pot and pan sinks, dishwashers, soup kettles, and floor drains located in areas where grease-containing materials may exist, may be drained into the sanitary waste through the interceptor when approved by the Authority Having Jurisdiction.

**H 102.2** Toilets, urinals, and other similar fixtures shall not drain through the interceptor.

**H 102.3** All waste shall enter the interceptor through the inlet pipe only.

#### H 103.0 Design.

**H 103.1** Interceptors shall be constructed in accordance with the design approved by the Authority Having Jurisdiction and shall have a minimum of two compartments with fittings designed for grease retention.

**H 103.2** There shall be an adequate number of manholes to provide access for cleaning all areas of an interceptor, a minimum of one (1) per ten (10) feet (3048 mm) of interceptor length. Manhole covers shall be gastight in construction, a minimum opening dimension of twenty (20) inches (508 mm).

**H 103.3** In areas where traffic may exist, the interceptor shall be designed to have adequate reinforcement and cover.

#### H 104.0 Location.

**H 104.1** Each grease interceptor shall be so installed and connected that it shall be at all times easily accessible for inspection, cleaning, and removal of the intercepted grease. A grease interceptor may not be installed in any part of a building where food is handled. Location of the grease interceptor shall meet the approval of the Authority Having Jurisdiction.

**H 104.2** Interceptors shall be placed as close as practical to the fixtures they serve.

**H 104.3** Each business establishment for which a grease interceptor is required shall have an interceptor which shall serve only that establishment.

#### H 105.0 Construction Requirements.

**H 105.1 Purpose.** Grease interceptors shall be designed to remove grease from effluent and shall be sized in accordance with this appendix. Grease interceptors shall also be designed to retain grease until accumulations can be removed by pumping the interceptor. It is recommended that a sample box be located at the outlet end of all grease interceptors so that the Authority Having Jurisdiction can periodically sample effluent quality.

**H 105.2 Dimension and Tolerance Requirements.** Drawings shall be complete and shall show all dimensions, capacities, reinforcing, and structural design calculations.

**H 105.2.1** Grease interceptors shall have two (2) compartments. The inlet compartment shall be two-thirds (2/3) of the total capacity of the interceptor, shall have a minimum liquid volume of three hundred thirty three (333) gallons (1260 L), and in all cases shall be longer than the maximum inside width of the interceptor. The outlet compartment shall have a minimum capacity of one-third (1/3) of the total interceptor capacity. The liquid depth shall not be less than two feet six inches (2' 6") (362 mm) nor more than six feet (6') (1829 mm).

**H 105.2.2** All grease interceptors shall have at least one (1) square foot (0.09 m<sup>2</sup>) of surface area for every forty-five (45) gallons (170 L) of liquid capacity.

**H 105.2.3** Access to each grease interceptor shall be provided by a manhole over the inlet and a manhole over the outlet. There shall also be an access manhole for each ten (10) feet (3048 mm) of length for interceptors over twenty (20) feet (6096 mm) long. Each such access opening shall have a leak-resistant closure (i.e., lid) that cannot slide, rotate, or flip, which exposes the opening when properly installed, and which does not require the use of mechanical fasteners.

#### Note:

The intention is that a child-resistant lid be provided. Mechanical fasteners are recommended to augment the safety of and ensure positive closure of the lid.



Manholes shall extend to grade, have a minimum size of 20 inches (508 mm) diameter or 20 inches x 20 inches square (508 mm x 508 mm), and shall have a gasketed cover at grade.

**H 105.2.4** The inlet and outlet shall have a baffle tee or similar flow device with a minimum cross-sectional area equal to the required cross-sectional area of the inlet. Each baffle shall extend from at least four (4) inches (102 mm) above the liquid level to within at least twelve (12) inches (305 mm) of the inside floor of the interceptor.

**H 105.2.5** Adequate partitions or baffles of sound-durable material shall be constructed between compartments of the grease interceptor and shall extend at least six (6) inches (152 mm) above the liquid level. Flow from inlet compartment to outlet compartment shall be through a quarter bend, or similar device equivalent in cross-sectional area to the inlet into the interceptor and shall extend down to within twelve (12) inches (305 mm) of the inside floor. Wooden baffles are prohibited.

**H 105.2.6** Inlet, outlet, and main baffle shall have a free vent area equal to the required cross-sectional area of the inlet pipe.

**H 105.2.7** The inside cover of the grease interceptor shall be minimum of nine (9) inches (229 mm) above the liquid level over the entire surface area of the interceptor. The airspace shall have a minimum capacity equal to 12-1/2 percent of the grease interceptor's liquid volume.

### **H 105.3 Structural Requirements.**

**H 105.3.1** Grease interceptors shall be designed to withstand all anticipated loads.

**H 105.3.2** Grease interceptors and covers shall be designed for an earth load of not less than five hundred (500) pounds per square foot (24 kPa) when the maximum coverage does not exceed three (3) feet (914 mm). Each interceptor and cover shall be structurally designed to withstand all anticipated earth or other loads and to be installed level and on a solid bed. Wood covers are prohibited. Grease interceptors for installation in traffic areas shall be designed to withstand an AASHTO H20-44 wheel load, an additional three (3) foot (914 mm) earth load with an assumed soil weight of one hundred (100) pounds, per square foot (4.8 kPa), and thirty (30) pounds per square foot (1.4 kPa) fluid equivalent sidewall pressure.

**H 105.3.3** Independent laboratory tests and engineering calculations certifying the grease interceptor capacity and structural stability shall be provided.

### **H 105.4 Material Requirements.**

**H 105.4.1 Concrete.** Concrete shall have a minimum compressive strength of four thousand (4000) pounds per square inch (27,579 kPa) and shall be made with type II/V low-alkali portland cement conforming to ASTM C 150, including the optional sulfate expansion requirement (Table 4). Concrete shall have a maximum water/cementing materials ratio of 6 gallons (22.7 L)/sack of cement complying with the following ASTM designations: ASTM C 260-86, *Specification for Air Entraining Admixtures for Concrete*; ASTM C 33-86, *Specification for Concrete Aggregates*; ASTM C 94-86, *Specification for Ready-Mix Concrete*; and ASTM C 618-85, *Specification for Fly Ash and Raw or Calcined Natural Pozzolan for Use as a Mineral Admixture in Portland Cement Concrete*.

**H 105.4.2** Walls shall have a thickness of at least three (3) inches (76 mm), except where engineering analysis and production methods can justify a lesser thickness.

**H 105.4.3** The minimum area of steel reinforcement in both directions of the structural elements shall be 0.0015 times the gross cross-sectional area of the reinforced section if of bars; and not less than three-fourths (3/4) as much if of welded wire fabric. All reinforcement shall be protected with a minimum of one (1) inch (25.4 mm) of concrete and shall comply with ASTM A 185-85, *Specification for Steel-Welded Wire Fabric, Plain for Concrete Reinforcement* and ASTM A 615, *Specification for Deformed and Plain Billet-Steel Bars for Concrete Reinforcement*. Tanks shall be of sufficient strength to resist stresses caused during handling and installation without structural cracking.

**H 105.4.4** If repairs are necessary, they shall be carried out in accordance with the established practices of the manufacturer in a manner that ensures that the repaired interceptor meets the requirements of this appendix.

**H 105.5 Steel.** Steel grease interceptors shall comply with the requirements for steel septic tanks in Section 4 of PS 1.

**H 105.6 Fiberglass-Reinforced Polyester.** Fiberglass-reinforced polyester grease interceptors shall comply with the requirements for fiberglass-reinforced polyester septic tanks in Section 4 of PS 1.

**H 105.6.1 Polyethylene.** Polyethylene grease interceptors shall comply with the requirements for polyethylene septic tanks in Section 4 of PS 1.

### **H 105.7.0 Watertight Testing.**

**H 105.7.1 Water Testing.** A sampling from each

manufacturer's production run shall be water tested. One sample shall be tested for each size interceptor manufactured. Sample interceptors shall be assembled per manufacturer's instructions, set level, and water raised to the flow-line of the outlet fitting.

Interceptors shall show no leakage from section seams, pinholes, or other imperfections. Any leakage is cause for rejection. When leakage occurs, additional water testing shall be done of, new samples after corrective measures in production or installation have been completed. Test reports shall show total number of interceptors tested, number passing, number failing, location, and cause of leakage. When leakage occurs, corrective measures taken shall be reported.

**H 105.8.0 Marking and Identification.**

**H 105.8.1** Grease interceptors shall be permanently and legibly marked with the following:

- (1) Manufacturer's name or trademark;
- (2) Model number;
- (3) Listing mark of a listing agency; and
- (4) Any other marking required by law.

**H 106.0 Sizing Criteria.**

**H 106.1 Parameters.** The parameters for sizing a grease interceptor for one or more fixtures are hydraulic loading and grease storage capacity.

**H 106.2 Sizing Formula.** The size of the interceptor shall be determined by using the method outlined in Table H-1.

**H 107.0 Effluent Sampling.**

An effluent sampling box on grease interceptors may be required by the Authority Having Jurisdiction.

**H 108.0 Abandoned Grease Interceptors.**

Abandoned grease interceptors shall be pumped and filled as required for abandoned sewers and sewage disposal facilities in Section 722.0.

**TABLE H-1**  
**Sizing of Grease Interceptors**

Number of meals per peak hour <sup>1</sup>	x	Waste flow rate <sup>2</sup>	x	Retention time <sup>3</sup>	x	Storage factor <sup>4</sup>	=	Interceptor size (liquid capacity)
<sup>1</sup>		Meals Served at Peak Hour						
<sup>2</sup>		Waste Flow Rate						
		a. With dishwasher				.6 gallon (22.7 L) flow		
		b. Without dishwasher				.5 gallon (18.9 L) flow		
		c. Single service kitchen				.2 gallon (7.6 L) flow		
		d. Food waste disposer				.1 gallon (3.8 L) flow		
<sup>3</sup>		Retention Times						
		Commercial kitchen waste						
		Dishwasher				.25 hours		
		Single service kitchen						
		Single serving				.15 hours		
<sup>4</sup>		Storage Factors						
		Fully equipped commercial kitchen				.8 hour operation: 1		
						16 hour operation: 2		
						24 hour operation: 3		
		Single Service Kitchen				.15		



"The information contained in this appendix is not part of this American National Standard (ANS) and has not been processed in accordance with ANSI's requirements for an ANS. As such, this appendix may contain material that has not been subjected to public review or a consensus process. In addition, it does not contain requirements necessary for conformance to the standard."

## APPENDIX I INSTALLATION STANDARDS

The following IAPMO Installation Standards are included here for the convenience of the users of the Uniform Plumbing Code. They are not considered as a part of the Uniform Plumbing Code unless formally adopted as such. These Installation Standards are independent, stand-alone documents published by the International Association of Plumbing and Mechanical Officials and are printed herein by the expressed written permission of IAPMO.

<b>Contents</b>		<b>Page</b>
IS 1-2003	Non-Metallic Building Sewers .....	295
IS 2-93	Tile-Lined Roman Bathtubs .....	299
IS 3-2000	Copper Plumbing Tube, Pipe and Fittings .....	305
IS 4-96	Tile-Lined Shower Receptors (and Replacements) .....	313
IS 5-92	ABS Building Drain, Waste, and Vent Pipe and Fittings .....	317
IS 6-00	Hubless Cast-Iron Sanitary and Rainwater Systems .....	323
IS 7-90	Polyethylene (PE) Cold-Water Building Supply and Yard Piping .....	325
IS 8-95 <sup>e1</sup>	PVC Cold Water Building Supply and Yard Piping .....	329
IS 9-95	PVC Building Drain, Waste, and Vent Pipe and Fittings .....	339
IS 11-87	ABS Sewer Pipe and Fittings .....	345
IS 12-93	Polyethylene (PE) for Gas Yard Piping .....	349
IS 13-2000	Protectively Coated Pipe .....	353
IS 15-82	Asbestos Cement Pressure Pipe for Water Service and Yard Piping .....	355
IS 16-84	Low-Pressure Air Test for Building Sewers .....	361
IS 18-85	Extra-Strength Vitrified Clay Pipe in Building Drains .....	367
IS 20-2000	CPVC Solvent-Cemented Hot and Cold Water Distribution Systems .....	369
IS 21-89	Welded Copper and Copper Alloy Water Tube .....	379
IS 26-2002	Trenchless Polyethylene (PE) Pipe for Sewer Laterals .....	387
IS 27-2001	Odor Control Systems for Water Closets .....	389
IS 28-2002	Composite PEX-AL-PEX Hot and PE-AL-PE Cold Water Distribution Systems .....	393

<sup>e1</sup>Editorial Changes Only.



**Installation Standard  
For  
NON-METALLIC BUILDING SEWERS**

**IAPMO IS 1-91**

**1.0 SCOPE**

1.1 Installation and material of non-metallic building sewer piping shall comply with this standard and the current edition of the Uniform Plumbing Code [UPC]<sup>TM</sup> published by the International Association of Plumbing and Mechanical Officials.

**Note:** The following sections of the 2003 Uniform Plumbing Code apply to non-metallic building sewer piping. The standard may include section numbers or may omit section numbers which pertain to non-metallic sewers.

- 301.1 Minimum Standards
- 310.0 Workmanship
- 311.0 Prohibited Fittings and Practices
- 313.0 Protection of Piping Materials and Structures
- 315.0 Trenching, Excavation and Backfill
- 723.0 Building Sewer Test
- 103.5.3.3 Exceptions
- 705.1 Types of Joints
- 705.2 Use of Joints
- 316.2.3 Plastic Pipe to Other Materials
- 316.4 Prohibited Joints and Connections
- 317.0 Increases and Reducers
- Chapter 7 Sanitary Drainage

**2.0 GENERAL REQUIREMENTS**

- 2.1 After inspection of the sewer pipe, carefully backfill the trench as prescribed by Sections 314.0 and 315.0 of the Uniform Plumbing Code.
- 2.2 The same water test procedure shall apply to all non-metallic house sewer materials as required in Section 723.0 of the Uniform Plumbing Code.  
Before laying non-metallic sewer pipe, prepare the bottom trench so that the piping shall lay on a firm bed throughout its entire length as required by Section 718.0 of the Uniform Plumbing Code.

**3.0 PRODUCT REQUIREMENTS**

- 3.1 ABS OR PVC-DWV PIPE
- 3.1.1 Minimum Standards  
ABS or PVC Schedule 40 DWV pipe for use

in domestic sewage, excluding special waste shall be installed in accordance with IAPMO Standards IS 5 and IS 9 (latest edition), whichever is applicable. ABS or PVC Schedule 40 DWV pipe, IAPMO listed, may be used in sizes 2 inch (51 mm) and larger. [UPC 301.1]

**3.1.2 Markings**

- 3.1.2.1 **ABS Pipe.** ABS pipe markings shall be in accordance with D 2661 or F 628. [UPC 716.0]
- 3.1.2.2 **ABS Fittings.** ABS fittings markings shall be in accordance with D 2661. [UPC 716.0]
- 3.1.2.3 **PVC Pipe.** PVC pipe markings shall be in accordance with D 2665. [UPC 716.0]
- 3.1.2.4 **PVC Fittings.** PVC fittings markings shall be in accordance with F 2135. [UPC 716.0]

**3.1.3 Protection of Building Sewers**

ABS or PVC Schedule 40 pipe shall be installed a minimum of 1 foot (305 mm) below the surface of the finished grade. Underground installation of thermoplastic sewer pipe shall be in accordance with ASTM D 2321. [UPC 718.0]

**3.1.4 Cleanouts**

Cleanouts, extended to within 1 foot (305 mm) of grade, shall be of materials listed for that use. [UPC 719.0]

**3.2 PVC SEWER PIPE**

**3.2.1 Minimum Standards**

**3.2.1.1 Pipe**

PVC, PSM, SDR 35, ASTM D 3034 and PVC, PS-46, ASTM F 789 Non-Pressure Pipe may be used in sizes four (4) inches (102 mm) and larger. [UPC 301.1]

**3.2.1.2 Fittings**

All fittings shall be PVC or other listed non-metallic materials having equivalent durability and equal or greater strengths. [UPC 301.1]

**3.2.2 Types of Joints**

PVC sewer pipe shall be joined by using compression joints or by other methods recognized in the UPC. Pipe and fitting

ends shall be lubricated with an approved soap jelly or soap solution to permit easy assembly. [UPC 705.1]

### 3.2.2.1 Use of Joints

PVC sewer pipe shall be installed using the same type of jointing throughout, except when connecting to existing piping, piping of other materials, in line repairs and manholes. Transition connections to other materials shall be made by adapter fittings or a one-piece molded rubber coupling with appropriate bushings for the respective material. [UPC 705.1]

### 3.2.3 Markings

**3.2.3.1** PSM PVC pipe markings shall be in accordance with D 3034. [UPC 716.0]

**3.2.3.2** PSM PVC fitting markings shall be in accordance with D 3034. [UPC 716.0]

**3.2.3.3** PS-46 PVC pipe markings shall be in accordance with F 789. [UPC 716.0]

**3.2.3.4** PS-46 PVC fitting markings shall be in accordance with F 789. [UPC 716.0]

**3.2.4** PVC sewer pipe shall not be installed less than 1 foot (305 mm) below the surface of the finished grade and closer than twenty-four (24) inches (610 mm) from a building. Underground installation of thermoplastic sewer pipe shall be in accordance with ASTM D 2321. [UPC 718.0]

### 3.2.5 Cleanouts

Cleanouts, extended to within 1 foot (305 mm) of grade, shall be of materials listed for such use. [UPC 719.0]

## 3.3 HIGH DENSITY POLYETHYLENE PIPE

### 3.3.1 Minimum Standards

**3.3.1.1** Polyethylene pipe shall be manufactured in accordance with ASTM F 714 and installed in accordance with IAPMO IS 26. [UPC 301.1]

### 3.3.2 Types of Joints

**3.3.2.1** HDPE joints shall be made using the following method:

a) Heat Fusion made in accordance with ASTM D 2657 or D 3261. [UPC 705.1]

### 3.3.3 Markings

**3.3.3.1** Markings shall be in accordance with F 714. [UPC 716.0]

## 3.4 POLY VINYL CHLORIDE (PVC) CORRUGATED SEWER PIPE WITH A SMOOTH INTERIOR AND FITTINGS

### 3.4.1 Minimum Standards

**3.4.1.1 Pipe.** Corrugated PVC sewer pipe may be used in sizes four (4) (102 mm), six (6) (152 mm), eight (8) (203 mm) and ten (10) (254 mm) diameters and shall conform to ASTM F 949. [UPC 301.1]

The profile wall pipe corrugated PVC sewer pipe as intended for underground use in non-pressure applications for sanitary sewers, storm sewer, and perforated and unperforated pipes for subdrainage. [UPC 301.1]

**3.4.1.2** Fittings shall be PVC or other fittings having equivalent durability or equal or greater strengths in accordance with ASTM F 949. [UPC 301.1]

**3.4.2** Types and Use of Joints. Corrugated PVC sewer pipe shall be joined by Molded Molded or Elastomeric Compression Joints or by other approved methods. Elastomeric seals (gaskets) shall meet the requirements of ASTM F 477. The lubricant used for assembly shall be as recommended by the seller and shall have no detrimental affect on the gasket or on the pipe and fittings. The PVC cement shall comply with ASTM D 2564 and shall be used in conjunction with a primer in compliance with ASTM F 656. The solvent cement shall be used only for bushings in accordance with ASTM D 2855. [UPC 316.1, 705.1, 705.3]

### 3.4.3 Markings

**3.4.3.1** Corrugated PVC sewer pipe markings shall be in accordance with F 949. [UPC 716.0]

**3.4.3.2** Corrugated PVC fittings markings shall be in accordance with F 949. [UPC 716.0]

**3.4.4 Protection of Building Sewer.** Corrugated PVC sewer pipe shall not be installed less than 1 foot (305 mm) below the surface of the finished grade and closer than twenty-four (24) inches (610 mm) from a building. Underground installation of thermoplastic sewer pipe shall be in accordance with ASTM D 2321. [UPC 718.3]

**3.4.5 Cleanouts.** Cleanouts, extended to within 1 foot (305 mm) of grade, shall be of materials listed for such use. [UPC 719.0]

## 3.5 ASBESTOS CEMENT SEWER PIPE

### 3.5.1 Minimum Standards

Asbestos cement sewer pipe shall be Type II only and may be used only in sizes four (4)

- inches (102 mm) and larger. Its use is limited to domestic sewage. [UPC 301.1]
- 3.5.2** All fittings used with asbestos cement sewer pipe shall be asbestos cement or other approved non-metallic materials having equivalent durability and providing fittings with equal or greater strengths. [UPC 705.0]
- 3.5.3** Asbestos cement sewer pipe and male end fittings shall be joined by means of a sleeve coupling and two rubber sealing rings suitable for the particular size of the pipe and fittings for which they will be used. The rubber sealing rings shall be positioned in interior grooves in the coupling. The assembled joint shall provide the necessary compression of the rubber sealing rings to make a watertight joint. The crush strength across the assembled joint shall be equivalent to the crush strength of the pipe with which it will be used. [UPC 705.1]
- 3.5.3.1** The use of unmachined field-cut asbestos cement sewer pipe is permitted for necessary length adjustments and at points of connection to other piping materials. These adaptations shall be made with either a one-piece molded rubber coupling with appropriate bushings or listed adapter fittings. [UPC 705.1]
- 3.5.3.2** Approved female fittings shall be provided with interior grooves in the bell ends in which rubber sealing rings, suitable for the particular size of pipe with which the fittings will be used, are placed. The compressed rubber sealing ring in the joined female (bell) fitting end shall provide a watertight joint. [UPC 705.1]
- 3.5.3.3** Pipe and fitting ends shall be lubricated with an approved jelly or soap solution to permit easy assembly. [UPC 705.1]
- 3.5.3.4** A listed one-piece molded rubber coupling with appropriate bushings may be used as an alternate means of connecting asbestos cement pipe and male end fittings. [UPC 705.1]
- 3.5.3.5** Transition from asbestos cement sewer pipe to another material shall be made by listed adapter fittings, or a one-piece molded coupling with appropriate bushings for the respective material. [UPC 705.1]
- 3.5.4** **Markings**
- 3.5.4.1** Asbestos cement sewer pipe markings shall be in accordance with C 428. [UPC 716.0]
- 3.5.4.2** Each coupling sleeve of fitting markings shall be in accordance with C 428. [UPC 716.0]
- 3.5.5** No asbestos cement sewer pipe shall be installed less than 1 foot (305 mm) below the surface of the ground or closer than two (2) feet (610 mm) to a building. [UPC 718.3]
- 3.5.6** Cleanouts shall be asbestos cement or other approved materials of plug or cap type installed with rubber ring compression joints. Cleanouts, extended to within 1 foot (305 mm) of the surface, shall be of materials approved for such use. [UPC 719.0]
- 3.6** **CONCRETE SEWER PIPE**
- 3.6.1** **Minimum Standards**
- 3.6.1.1** **Pipe and Fittings**
- Concrete sewer pipe may be used in sizes four (4) inches (102 mm) and larger. Concrete sewer pipe shall conform to ASTM C 14, Class 2. Transition to other types or sizes of pipe may be made with listed concrete pipe adapter fittings or listed one-piece molded rubber coupling with appropriate bushings or increasers. [UPC 301.1]
- 3.6.2** **Types of Joints**
- Concrete sewer pipe and fittings shall be joined by means of flexible rubber sealing rings, compressed to provide water-tight joints conforming to ASTM C 443, or by listed one-piece molded rubber couplings, or hot-poured joints of listed hot-pour compounds. Portland Cement joints are prohibited except for repairs or connections to existing lines constructed with such joints. Concrete sewer pipe shall be joined by gaskets furnished by the pipe manufacturer and installed according to the manufacturer's instructions. Approved lubricant shall be used when required for the type of joint furnished. [UPC 705.1]
- 3.6.3** **Use of Joints**
- Except for points of connection to existing piping at either end of the sewer, concrete sewer pipe shall be laid using the same type of jointing throughout. [UPC 705.2]
- 3.6.4** **Markings**
- 3.6.4.1** Concrete sewer pipe and fittings markings shall be in accordance with C 14. [UPC



716.0]

installed less than 1 foot (305 mm) below the surface of the ground. [UPC 718.3]

### 3.6.5 **Grade, Support and Protection of Building Sewers**

Concrete sewer pipe shall be installed not less than 1 foot (305 mm) below the ground and not closer than two (2) feet (610 mm) to a building. [UPC 718.0]

### 3.7.5 **Cleanouts**

Cleanouts shall conform to the type of jointing used and cleanouts extended to within 1 foot (305 mm) of grade shall be of materials approved for their use. [UPC 719.0]

### 3.6.6 **Cleanouts**

Cleanouts shall conform to type of jointing used and cleanouts extended to within 1 foot (305 mm) of grade, shall be of materials listed for that use. [UPC 719.0]

**ADOPTED: 1957**

**REVISED: 1966, 1971, 1973, 1975, 1976, 1982, 1985, 1990, 1991, 2002, 2003**

## 3.7 **VITRIFIED CLAY PIPE**

### 3.7.1 **Minimum Standards**

**3.7.1.1 **Materials.**** Materials shall comply with the appropriate standard in Table 14-1 of the UPC. Vitrified clay sewer pipe, extra strength only, may be used in sizes three (3) inches (76 mm) and larger. [UPC 301.1]

### 3.7.2 **Types of Joints**

Vitrified clay sewer pipe and fittings shall be joined by means of preformed flexible compression joints or listed one-piece molded rubber couplings. [UPC 705.1]

**3.7.2.1** Except at point of connection to existing piping at either end of the sewer, vitrified clay sewer piping shall be laid using the same type of jointing throughout. [UPC 705.1]

**3.7.2.2** When installing clay pipe with flexible compression joints, the mating surfaces shall be wiped clean of dirt and foreign matter. An approved lubricant shall be applied to the joint surfaces. Spigot shall then be seated full depth into the bell. [UPC 705.1]

**3.7.2.3** Listed one-piece molded rubber couplings shall be permitted for use on vitrified clay pipe and fittings, sizes three (3) inches (76 mm) through 1 foot (305 mm). [UPC 705.1]

**3.7.2.4** Transition to other types of materials or sizes may be made with the use of listed one-piece molded, rubber couplings with appropriate bushings or increasers. [UPC 705.1]

### 3.7.3 **Markings**

**3.7.3.1** Vitrified clay sewer pipe and fittings markings shall be in accordance with C 700. [UPC 716.0]

**3.7.4** No vitrified clay sewer pipe shall be

# Installation Standard For Tile-Lined Roman Bathtubs IAPMO IS 2-93

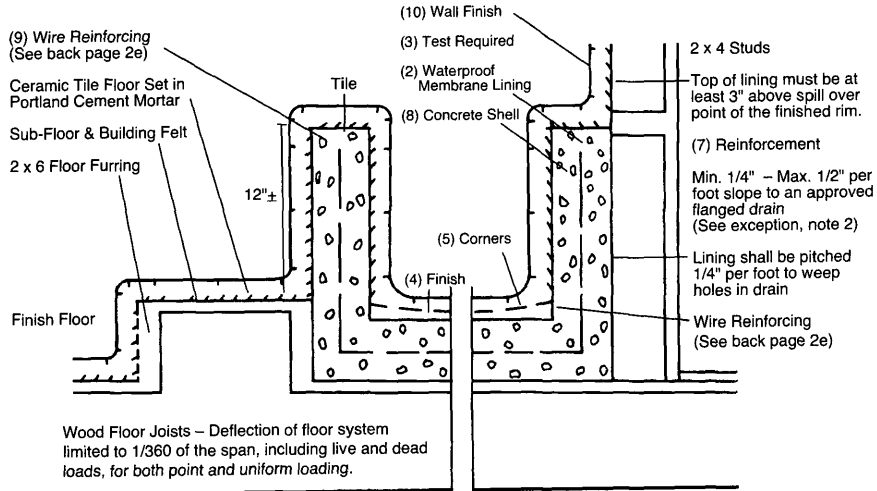

SCALE 1-1/2" = 1' - 0"

A vapor barrier consisting of at least one layer of 15 lb. type asphalt saturated felt shall be between wood surfaces and concrete.

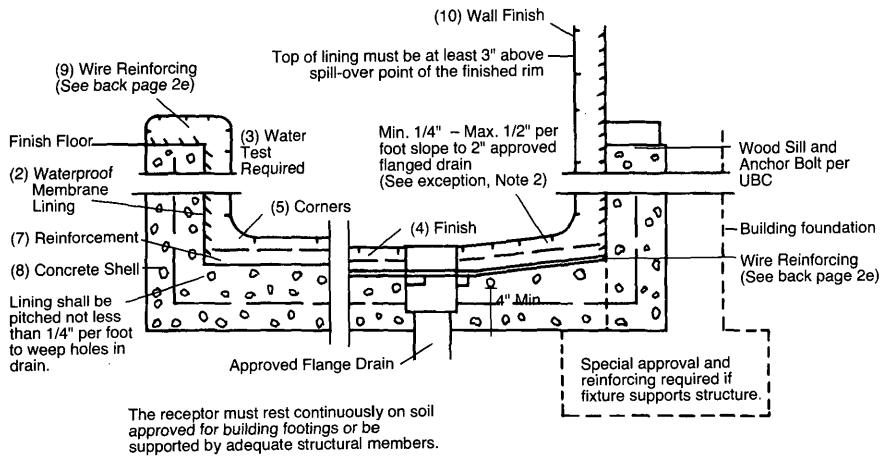

SCALE 1-1/2" = 1' - 0"

Illustrations reprinted with permission of the Ceramic Tile Institute

METRIC

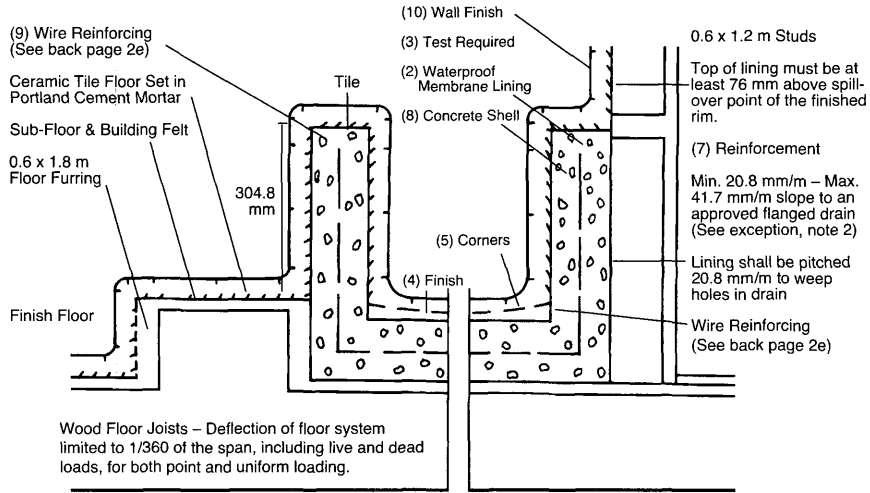

SCALE 1.5 mm = 1 mm

A vapor barrier consisting of at least one layer of 6.8 kg type asphalt saturated felt shall be between wood surfaces and concrete.

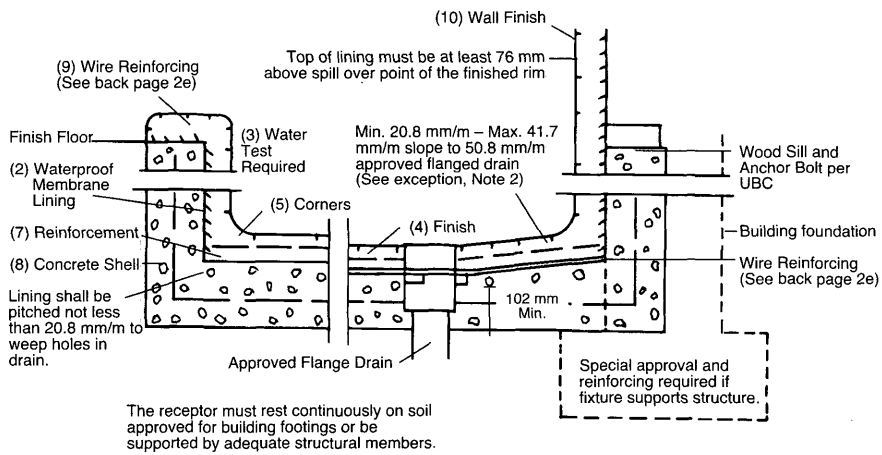

SCALE 1.5 mm = 1 mm

Illustrations reprinted with permission of the Ceramic Tile Institute

**1.0 GENERAL REQUIREMENTS**

**1.1 Inspection of Work** – All surfaces prepared by others shall be inspected by the tile installer before starting tile work and all unsatisfactory conditions reported to the Administrative Authority. Starting tile work by the tile installer shall be considered as acceptance of surfaces prepared by others.

**1.2 Surfaces** – All surfaces to receive tile work shall be clean, structurally sound, and conform in every way to the local Building Code.

(Note: No tile work shall proceed until the pan and drain construction has been inspected and approved by the Administrative Authority, where required.)

**2.0 MATERIALS**

**2.1 Tile Quality and Grade** – Tile shall comply with American National Standard Specification for Ceramic Tile, A137.1 (equivalent to and incorporating U.S. Dept. of Commerce Simplified Practice Recommendation, R61-61 and Federal Specification SS-T-308b, Tile, Floor, Wall, and Trim Units, Ceramic).

**2.2 Cement** – Cement shall be portland cement type I or type II, conforming to ASTM C 150.

**2.3 Sand** – Sand shall be damp, clean and graded ASTM C 778.

**2.4 Water** – Water shall be potable.

**2.5 Reinforcing** shall be 3 inch x 3 inch (76 mm x 76 mm), 13 x 13 gage or 1-1/2 x 2 (38 mm x 51 mm) mesh, 16 x 13 gage steel wire, conforming to ASTM A82 and A185.

**2.6 Asphalt** shall conform to Federal Specification SS-A-0666, Type Z, Grade 2, Class A.

**2.7 Plastic Roof Cement** shall conform to Federal Specification SS-C153.

**2.8 Waterproof Felt Membrane** – The waterproof felt membrane shall be at least 15 lb. (6.8 kg) asphalt saturated felt, conforming to Type I, Federal Specification HH-F-191 (a).

**2.9 Plastic Membrane** shall comply with applicable standards listed in Table 14-1 of the UPC.

**2.10 Other Membranes** – Where the Administrative Authority approves their use, non-metallic sub-pans or linings of lead sheets weighing not less than 4 lbs. per sq. foot (191.5 Pa) and copper pans of at least No. 24 B & S gage may be used.

**2.11 Waterproofing Admixture** – The mortar

bed of the receptor shall be mixed with a waterproof admixture, approved by the Administrative Authority in the amounts allowed by such approval.

**2.11.1** Currently Approved Mortar Additives  
Anti-Hydro – 1 qt. (0.95 I) per sack of cement

Plastiment – 1 lb. (0.5 kg) of powder per sack of cement

Plastiment – 2 oz. (56.7 g) of fluid per sack of cement

Sika 3A – 1 qt. (0.95 I) per sack of cement

Suconem (Red Label) – 1 pint (0.47 I) per sack of cement

**3.0 INSTALLATION**

**3.1 Drains** – An approved type drain with sub-drain shall be installed with every such shower membrane. Flange of each sub-drain shall be accurately set exactly level with sloping sub-floor and shall be equipped with a clamping ring or other approved device to make a tight connection between the membrane and the sub-drain. The sub-drain shall have weep holes into the waste line. The drain shall be of such design that there will be not less than 2 inch (51 mm) depth from the top of the sub-drain flange to top of the strainer. A ring of absorbent material must be placed around the weep holes to keep them open when the finish materials are installed.

**3.2 Sloping Sub-Floor and Membrane** – All lining materials shall be pitched not less than one quarter (1/4) inch per foot (20.8 mm/m) to weep holes in the sub-drain by means of a smooth and solidly formed sloping sub-base. All such lining materials shall extend upward on the side walls of the tub to a point not less than four (4) inches (102 mm) above the top of the finished dam or threshold and shall extend outward over the top of the rough threshold and be turned over and fastened on the outside face of the rough threshold. All ledge tops within four (4) inches (102 mm) above the rough threshold shall be covered with the lining material. Non-metallic sub-pans or linings shall be built-up on the job site and shall consist of not less than three (3) layers of standard grade fifteen (15) pound (6.8 kg) asphalt impregnated roofing felt. The bottom layer shall be mopped to the formed sub-base with hot asphalt and each

succeeding layer thoroughly hot-mopped to that below, on the basis of twenty (20) pounds (9.1 kg) of asphalt per layer per square. All corners shall be carefully fitted and shall be made strong and watertight by folding or lapping, and each corner shall be reinforced with suitable woven glass fiber webbing hot-mopped in place. All folds, laps and reinforcing webbing shall extend at least four (4) inches (102 mm) in all directions from the corner and all glass fiber webbing shall be of approved type and mesh, producing a tear strength of not less than fifty (50) pounds per square inch (344.5 kPa) in either direction. Non-metallic shower sub-pans or linings may also consist of multilayers of other approved equivalent materials suitably reinforced with glass fibers and having each layer carefully fitted and hot mopped in place on the job site as elsewhere required in this section, according to manufacturer's recommended installation procedures.

Linings shall not be nailed or perforated at any point which will be less than one (1) inch (25.4 mm) above the finished dam or threshold.

Where flexible plastic sheet membranes are used, corners shall be carefully constructed by folding or bonding of pre-fabricated reinforcing corner. Joints in flexible plastic sheeting shall be constructed with the appropriate solvent bonding liquid, bodied solvent cement or thermal welding.

Where lead and copper pans are used as membranes, the installation shall be made in similar manner as required for felt membranes, except the asphalt moppings, and, in addition, the pans shall be insulated from all concrete and mortar surfaces and from all conducting substances, other than their connecting drain, by 15 lb. (6.8 kg) asphalt saturated felt or an approved equivalent, hot-mopped to the lead or copper pans. Joints in lead and copper pans shall not be soldered, but shall be burned or silver brazed, respectively.

**3.3 Tests** – Upon installation, all concrete tub shells shall be tested for water tightness by being filled to the top of the rough threshold with water for 24-hours to establish their water tightness.

**3.4 Roman Bath Tub** – Floor shall be of ceramic tile set in portland cement mortar, mixed in the proportion of one (1) part portland cement to four (4) parts of mortar sand by volume and shall be provided with an approved shower drain designed to make a water-tight joint at the floor. The mortar mixture shall be of such consistency that a troweled surface readily assumes a smooth, slickened surface. All concrete mortar bases shall be mixed with an approved waterproofing admixture and properly reinforced with 3 inch x 3 inch (76 mm x 76 mm) mesh, 13 x 13 gage or 1-1/2 inch x 2 inch (38 mm x 51 mm) mesh, 16 x 13 gage cold drawn welded steel wire fabric located in the approximate center of the

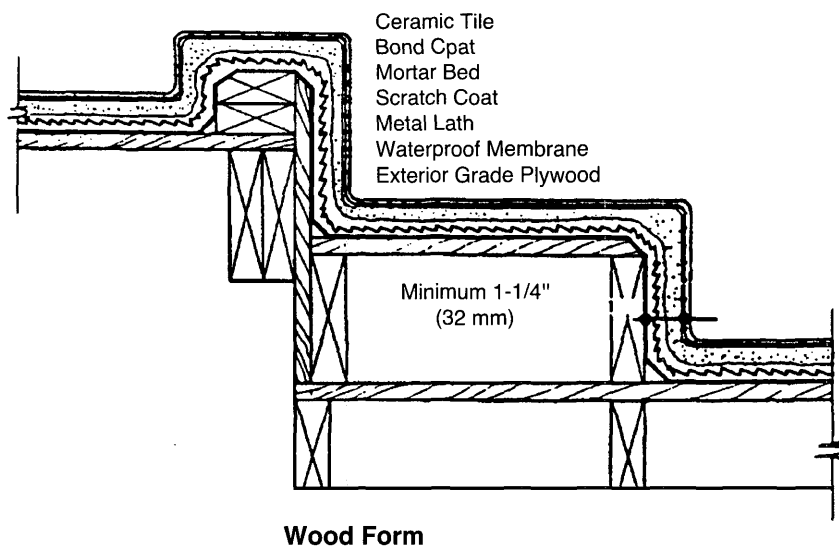

mortar bed and extending up the side walls but, in no case, less than 1 inch (25.4 mm) above the finished threshold. Corners shall be lapped and the reinforcing shall extend over the threshold and ledges.

The total thickness of the floor mortar shall not be less than 1-1/4 inch (32 mm) at any point. The tile floor shall have a minimum of 1/8 inch (3.2 mm/m) pitch and a maximum of 1/2 inch (12.7 mm/m) pitch toward the drain per foot. Bath tub walls to a minimum height to 3 inch (76 mm) and not less than 1 inch (25.4 mm) above the finished dam shall be lined with ceramic tile set in portland cement mortar, mixed with an approved waterproofing admixture.

All wood framed bases shall be designed with a maximum deflection of 1/240 of the span, including live and dead loads.

**3.4.1 Note:** two stages of construction are covered – the reinforced concrete shell and the wire reinforced tile lining over the waterproof membrane.

**3.4.2** Approved waterproofing membrane, mortar bed and finish construction shall conform to the general requirements of the Uniform Plumbing Code. Exception: In short sections where there is no foot traffic, the finished floor may exceed 1/2 inch per foot (12.7 mm/m) slope.

**3.4.3** Each concrete shell shall be filled to its overflow rim with water and shall remain watertight for not less than twenty-four (24) hours before inspection and before the finish surface is installed.

**3.4.4** The finish surface shall be ceramic tile installed with portland cement mortar mixed to a proper consistency in the proportion of one (1) part cement and four (4) parts mortar sand by volume and having an approved waterproofing admixture\* included. Ceramic tile joints shall be thoroughly grouted with approved waterproofing grout containing an admixture.

**3.4.5** The concave interior surfaces shall be such as to permit ready cleansing and all corners shall be rounded or at angles not in excess of 45°. Grout is not acceptable for rounding corners. See details below on approved corners.

**3.4.6** Concealed overflow or built-in waste stopper may be used if designed and approved for this application.

**3.4.7** Reinforcement in center of pour, use #30 @

8 inch (203 mm) O.C. both ways.

**3.4.8** 2000 P.S.I. (13,780 kPa) compressive strength concrete poured monolithically and having an approved waterproofing admixture included\*. Concrete to have not less than six (6) sacks of portland cement per batch.

**3.4.9** Reinforcing wire, as specified under materials in this standard or equal, shall be wired together in a self-supporting manner. Nails shall not be used through the waterproofing membrane to fasten wire reinforcing.

\*Quantities of several approved waterproofing admixtures required per sack of cement:

Anti-Hydro – 1 qt. (0.95 l) per sack of cement

Plastiment – 1 lb. (0.5 kg) of powder per sack of cement

Plastiment – 2 oz. (56.7 g) of fluid per sack of cement

Sika 3A – 1 qt. (0.95 l) per sack of cement

Suconem (Red Label) – 1 pint (0.47 l) per sack of cement

**ADOPTED: 1966**

**REVISED: 1977, 1982, 1990, 2003**

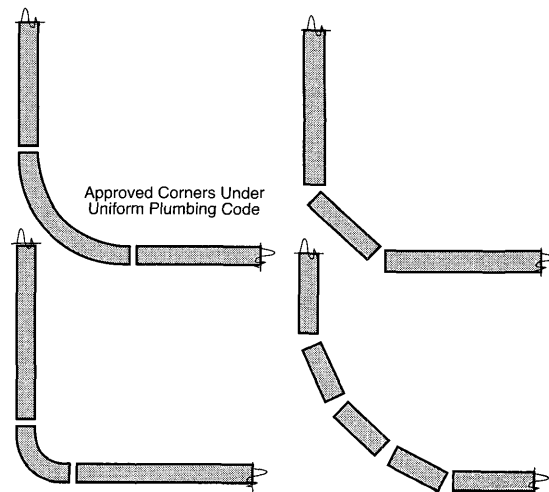



**Installation Standard  
For  
COPPER PLUMBING TUBE, PIPE, AND FITTINGS**

**IAPMO IS 3-2000**

Installation and material of copper tube, pipe, and fittings in drainage, vent, and water systems shall comply with this standard and the current edition of the Uniform Plumbing Code, published by the International Association of Plumbing and Mechanical Officials (IAPMO).

*Note: The following sections of the UPC shall apply.*

*Table 14-1 Standards*

ASTM B 42-93	Specification for Seamless Copper Pipe, Standard Sizes
ASTM B 75-93	Specification for Seamless Copper Tubes
ASTM B 88-93a	Specification for Seamless Copper Water Tube
ASTM B 302-92	Specification for Threadless Copper Pipe
ASTM B 306-92	Specification for Copper Drainage Tube (DWV)
ASTM B 828-92 <sup>et</sup>	Standard Practice for Making Capillary Joints by Soldering of Copper and Copper Alloy Tube and Fittings
ANSI B 16.18-84	Cast Copper Alloy Solder-Joint Pressure Fittings
ANSI B 16.22-95	Wrought Copper and Copper Alloy Solder-Joint Pressure Fittings
ANSI B 16.23-92	Cast Bronze Solder-Joint Drainage Fittings -DWV
ANSI B 16.29-86	Wrought Copper and Copper Alloy Solder-Joint Drainage Fittings

- 301.1 Minimum Standards
- 903.2 Use of Copper Tubing
- 701.1.4 Underground drainage and vent piping
- 701.1.5 Aboveground drainage and vent piping
- 811.1 Chemical or Industrial waste piping
- 604.2 Water piping
- 604.3 Marking of tubing
- 604.4 Flexible Water Connectors
- 704.4.1 Closet Flanges

- 707.1 Cleanouts
- 310.0 Workmanship
- 311.0 Prohibited Fittings and Practices
- 313.0 Protection of Piping Materials and Structures
- 314.0 Hangers and Supports, Horizontal and Vertical piping
- 103.5.3 Test
- 701.0 Materials, drainage piping
- 903.0 Materials, vent piping
- 316.1 Types of Joints
- 316.1.2 Wiped Joints
- 316.1.3 Solder and sweat
- 606.1.1 Flared Joints
- 606.2.1 Use of Joints, Copper Water Tube
- 316.2 Special Joints
- 316.2.1 Copper Tubing to Screw Pipe Joints
- 705.4.3 Ground Joint, Flared or Ferrule Connections
- 316.4 Prohibited Joints and Connections
- 317.0 Increases and Reducers
- 604.0 Materials
- 604.1 Water piping
- 604.7 Restriction of Used Piping
- 608.0 Relief Valve Drain
- 609.0 Installation, Inspection, Testing
- 610.0 Size of potable piping

- Appendix A Chart A-4 Friction loss per 100 ft (30.5 m)
- Appendix D D 1.0 Materials, rainwater piping
- D 2.0 Materials, roof drains

**301.1 Minimum Standards**

**301.1.1 Materials.** Materials shall comply with the appropriate standard in Table 14-1 of the UPC.

*Note: The nominal or standard size of copper plumbing tube is always 0.125 inch (3.8 mm) or one-eighth (1/8) inch (3.2 mm) smaller than the actual outside diameter dimension of the tube. For example, 3 inch (76 mm) nominal size copper plumbing tube measures 3-1/8 inch (79 mm)*



O.D., 1/2 inch (12.7 mm) nominal size copper plumbing tube measures 5/8 inch (15.9 mm) O.D., etc.

**301.1.2 Markings.** Markings shall be visible for inspection. Products that are covered by this standard shall be labeled with the label of a listing agency.

**301.1.2.1 Tube and Threadless Pipe**

Water tube (Types K, L, M), drainage tube (Type DWV), and threadless pipe (TP), shall bear the following incised marking at not over 18 inch (457 mm) intervals:

- (a) Manufacturer's name or trademark,
- (b) Tube type, and
- (c) Country of origin.

**301.1.2.2 Pipe (Copper and Copper Alloy)**

Pipe shall bear the following incised marking at not over 18 inch (457 mm) intervals:

- (a) Manufacturer's name or trademark; and
- (b) Pipe type.

**301.1.2.3 Fittings**

Fittings shall bear the following markings:

- (a) Manufacturer's name or trademark, and
- (b) "DWV" on drainage fittings.

**316.1 Type of Joints**

**316.1.1 General Information**

Copper tube and fittings may be joined in a number of ways, depending on the purpose of the system. Soldering and brazing with capillary fittings are the methods used most.

The American Welding Society defines soldering as a joining process which takes place below 840°F (449°C) and brazing as a similar process which occurs above 840°F (449°C) but below the melting point of the base metals. In actual practice for copper systems, most soldering is done at temperatures from about 350°F (177°C) to 550°F (288°C), while most brazing is done at temperatures ranging from 1100°F (593°C) to 1500°F (816°C). The choice between soldering or brazing will generally depend on operating conditions. Solder joints are generally

used where the service temperature does not exceed 205°F (96°C), while brazed joints can be used where greater strength is required or where system temperatures are as high as 400°F (204°C).

Mechanical joints are used frequently for underground tubing, for joints where the use of heat is impractical, and for joints that may have to be disconnected from time to time.

**316.1.1.1 Fittings for Soldered, Brazed, and Flared Joints**

Fittings are available in all standard tube sizes and in a wide variety of types to cover needs for plumbing.

They can be either soldered or brazed, although brazing cast fittings requires care. Wrought copper pressure fittings are also available over a wide range of sizes and types. These, too, can be joined by either soldering or brazing, and wrought fittings are preferred where brazing is the joining method.

Otherwise, the choice between cast and wrought fittings is largely a matter of the user's preference. Flared-tube fittings provide metal-to-metal contact similar to ground joint unions; both can be easily taken apart and reassembled. They are especially useful where residual water cannot be removed from the tube and soldering is difficult. Flared joints may be required where a fire hazard exists and the use of a torch to make soldered or brazed joints is not allowed. Also, soldering under wet conditions can be very difficult and flared joints are preferred under such circumstances.

**316.1.1.2 Solders**

*Note: Users of the Uniform Plumbing Code are reminded that provisions of the Federal Clean Drinking Water Act of 1986, which all must obey, forbid the use of solder which contains in excess of 0.2 percent lead by volume in potable water systems. The provisions of the act are incorporated in all ordinances, statutes, state and municipal regulations by reference and by operation of law.*

The selection of a solder depends on the operating pressure and temperature of the line. Consideration should also be given to the stresses on the joint caused by thermal expansion and contraction.

However, stresses due to temperature changes should not be significant in two commonly encountered cases: when tube lengths are short, or when expansion loops are used in long tube runs.

Solder is generally used in wire form, but paste-type solders are also available. These are finely granulated solders in suspension in a paste flux. When using paste-type solders, observe these four rules:

- (1) Wire solder must be applied in addition to the paste to fill the voids and assist in displacing the flux; otherwise the surfaces may be well "tinned" and yet there may not be a good joint with a continuous bond.
- (2) The paste mixture must be thoroughly stirred if it has been standing in the can for more than a very short time, as the solder has a tendency to settle rapidly to the bottom.
- (3) The flux cannot be depended on to clean the tube. Cleaning should be done manually, as is recommended for any other flux and solder.
- (4) Remove any excess flux. Solders are available containing small amounts of silver or other additives to impart special properties. Such solders may require special fluxes. The manufacturer's recommendations should be consulted regarding proper procedures and fluxes for such solders and about the expected properties.

### 316.1.1.3 Soldering Flux

The functions of the soldering flux are to remove residual traces of oxides, to promote wetting, and to protect the surfaces to be soldered from oxidation during heating. The flux should be applied to clean surfaces, and only enough should be used to lightly coat the areas to be joined.

An oxide film may reform quickly on copper after it has been cleaned. Therefore, the flux should be applied as soon as possible after cleaning.

### Caution:

Careless workmanship, especially during flux applications, can result in corrosion of the tube long after the system has been installed. If excessive flux is used, the residue inside the tube can cause corrosion. In an extreme case, such residual flux can actually lead to perforation through the tube wall, causing leakage. To guard against this danger, it is important to (1) choose a flux that is not too corrosive and (2) to use only the minimum amount actually needed to make the joint.

### 316.1.2 Solder Joints

Soldering and brazing both involve basic steps which must be executed with care and craftsmanship. The steps are:

- (1) Measuring
- (2) Cutting
- (3) Reaming
- (4) Cleaning
- (5) Fluxing
- (6) Assembly and support
- (7) Heating
- (8) Applying the filler metal
- (9) Cooling and cleaning

Each step contributes to a strong, dependable joint.

#### 316.1.2.1 Measuring

The length of each tube segment must be accurate. Inaccuracy can compromise joint quality. If the tube is too short it will not reach all the way into the socket of the fitting and a proper joint cannot be made. If the tube segment is too long there is a danger of cocking the tube in the fitting and putting strain on the system, which could affect service life.

#### 316.1.2.2 Cutting

Once the tube is measured it can be cut. Cutting can be accomplished in a number of different ways to produce a satisfactory square end.

The tube can be cut with a disc-type tube cutter, a hacksaw, an abrasive wheel, or with a stationary or portable bandsaw. Care must be taken that the tube is not deformed while being cut. Regardless of the method, the cut must be square with the run of the tube so that the tube will seat properly in the fitting socket.

**316.1.2.3 Reaming**

All pipe and tube shall be reamed to the full ID of the pipe and tube. Tools used to ream tube ends include the reaming blade on the tube cutter, half-round or round files, a pocket knife, and a suitable deburring tool. With annealed tube, care must be taken not to deform the tube end by applying too much pressure. Both the inside and the outside of the tube may require removal of the burr.

**316.1.2.4 Cleaning**

The removal of oxides and surface soil is crucial if filler metal is to flow properly into the joint. Unremoved oxide, surface soil, and oil can interfere with the strength of the joint and cause failure.

Mechanical cleaning is a simple operation. The end of the tube should be abraded lightly using sand cloth or nylon abrasive pads for a distance only slightly more than the depth of the fitting socket. The socket of the fitting should also be cleaned using sand cloth, abrasive pads, or a properly sized fitting brush.

Copper is a relatively soft metal. If too much material is removed, a loose fit will result and interfere with satisfactory capillary action in making the joint. The capillary space between tube and fitting is approximately 0.004 inch (0.10 mm). Solder or brazing filler metal can fill this gap by capillary action. This spacing is critical for the filler metal to flow into the gap and form a strong joint.

Once cleaned, surfaces should not be touched with bare hands or oily gloves. Skin oils, lubricating oils, and grease impair solder flow and wetting.

**316.1.2.5 Fluxing**

Stir the flux before use. A good flux will dissolve and remove traces of oxide from the cleaned surfaces to be joined, protect the cleaned surfaces from reoxidation during heating, and promote wetting of the surfaces by the solder. A thin, even coating of flux should be applied with a brush to both tube and fitting. Do not apply with fingers. Chemicals in the flux can be

harmful if carried to the eyes or open cuts.

**316.1.2.6 Assembly and Support**

After both tube and fitting surfaces are properly fluxed, they should be assembled, making sure the tube seats against the base of the fitting socket. A slight twisting motion ensures even distribution by the flux. Remove excess flux. Care must be taken to ensure that the tube and fittings are properly supported with a uniform capillary space around the entire circumference of the joint. Uniformity of capillary space will ensure good filler metal penetration if the guidelines of successful joint-making are followed. Excessive joint clearance can cause the filler metal to crack under stress or vibration. The joint is now ready for soldering. Joints prepared and ready for soldering should be completed the same day and not left unfinished overnight.

**316.1.2.7 Heating**

Because an open flame may be used for soldering and because flammable gases are used, safety precautions must be observed. The heat is generally applied using an air/fuel torch. Such torches use acetylene or an LP gas. Electric resistance tools can also be used.

Heating should begin with the flame perpendicular to the tube. The copper tube conducts the initial heat into the fitting socket for even distribution of heat inside and out. The extent of this preheating depends upon the size of the joint. Experience will indicate the amount of time needed. The flame should now be moved onto the fitting. Then move the flame from the fitting socket back onto the tube a distance equal to the depth of the fitting socket. Touch the solder to the joint. If the solder does not melt, remove it and continue the heating process. Be careful not to overheat or to direct the flame into the fitting cup. This could cause the flux to burn and destroy its effectiveness. When the melting temperature of the solder has been reached, heat may be applied to the base of the cup to aid capillary action in drawing the solder into the cup.

**316.1.2.8 Applying the Filler Metal**

For tube in a horizontal position, start applying the solder slightly off-center at the bottom of the joint. Proceed across the bottom of the fitting and up to the top center position. Return to the point of beginning, overlap the starting point, and then proceed up the uncompleted side to the top again, overlapping the solder.

For joints in the vertical position, a similar sequence of overlapping passes should be made, starting wherever it is convenient. Molten solder will be drawn into the joint by capillary action regardless of whether the solder is being fed upward, downward, or horizontally.

**316.1.2.9 Cooling and Cleaning**

After the joint has been completed, natural cooling is best. Shock cooling with water may cause unnecessary stress on the joint and result in eventual failure. When cool, clean off any remaining flux with a wet rag.

**316.1.3 Brazed Joints**

Brazing is the second most commonly used method for joining copper tube. Making brazed joints is similar to making soldered joints with respect to measuring, cutting, reaming, cleaning, assembly and support. And as in soldering, the brazing filler metal is melted by the heat of the tube and fitting and drawn into the joint by capillary action.

The major differences between soldering and brazing are the:

- Type of flux used,
- Composition of filler metal, and
- Amount of heat required to melt the filler metal.

**316.1.3.1 Brazing Flux**

The fluxes used for brazing copper joints are different in composition from soldering fluxes. The two types cannot be used interchangeably. Brazing fluxes are water based, whereas most soldering fluxes are petroleum based. Similar to soldering fluxes, brazing fluxes dissolve and remove residual oxide from the metal surfaces, protect the metal from reoxidation during heating, and promote wetting of the

surfaces to be joined by the brazing filler metal.

Fluxes also provide the craftsman with an indication of temperature. Application of the flux is the same as when soldering. If the outside of the fitting and the heat-affected area of the tube are covered with flux (in addition to the end of the tube and the cup), oxidation will be prevented, and the appearance of the joint will be greatly improved.

**316.1.3.2 Brazing Filler Metals**

There are two general types of brazing filler metal used for joining copper tube. Classified according to their components, they are BCuP (Brazing-Copper-Phosphorus) and BAg (Brazing-Silver).

BCuP filler metals are preferred for joining copper tube and fittings. The phosphorus in them acts as a fluxing agent, and the lower percentage of silver makes them relatively low cost. When using copper tube, wrought copper fittings, and BCuP brazing filler metal, fluxing is optional. However, when cast fittings are brazed, flux must be used.

**316.1.3.3 Heating**

Oxy/fuel torches are generally used for brazing because of the higher temperatures required. Recent innovations in tip design make air/fuel torches useful on a wider range of sizes for brazing.

When working at brazing temperatures, safety precautions must be followed and care taken to protect both the operator and the materials being used. The heating operation is the same as for soldering. First preheat the tube and then the tube and fitting. When the filler metal starts to melt, apply heat at the base of the fitting socket to help draw the brazing filler metal in by capillary action.

**316.1.3.4 Applying Brazing Filler Metal**

Remember to allow the heat of the joint, not the flame, to melt the filler metal. The melted filler metal will be drawn into the joint by capillary action. It is very important that the flame be in continuous motion. It must not be allowed to remain on any one point long enough to burn through the tube or fitting.

If the filler metal fails to flow or has the tendency to ball up, it indicates either that there is oxide on the surfaces being joined or that the parts to be joined are not hot enough. If the filler metal refuses to enter the joint, the fitting cup is not hot enough. If it tends to flow over the outside of either part of the joint, it indicates that part is overheated. When the joint is completed, a continuous fillet should be visible completely around the joint.

Larger diameter tube is more difficult to heat to the desired temperature. The use of a heating tip or rosebud may be necessary to maintain the proper temperature over the area being brazed. Once total heat control is attained, follow the same procedures used for smaller tube.

### 316.1.3.5 Cooling and Cleaning

When the brazed joint is finished, allow it to cool naturally. Flux residues and some oxides formed by heating can be removed by washing with hot water and brushing with a stainless steel wire brush.

## 606.1.1 Flared Joints

### 606.1.1.1 Flared Joints with Impact Flaring Tools

- Step 1 Cut the tube to the required length.
- Step 2 Remove all burrs. This is very important to assure metal-to-metal contact.
- Step 3 Slip the coupling nut over the end of the tube.
- Step 4 Insert flaring tool into the tube end.
- Step 5 Drive the flaring tool by hammer strokes, expanding the end of the tube to the desired flare. This requires a few moderately light strokes.
- Step 6 Assemble the joint by placing the fitting squarely against the flare. Engage the coupling nut with the fitting threads. Tighten with two wrenches, one on the nut and one on the fitting.

### 606.1.1.2 Flared Joints with Screw-Type Flaring Tools

- Steps 1-3 Same as for impact flaring previously described.

- Step 4 Clamp the tube in the flaring block so that the end of the tube is slightly above the face of the block.
- Step 5 Place the yoke of the flaring tool on the block so that the beveled end of the compressor cone is over the tube end.
- Step 6 Turn the compressor screw down firmly, forming the flare between the chamber in the flaring block and the beveled compressor cone.
- Step 7 Remove the flaring tool. The joint can now be assembled as in Step 6 for impact flaring.

## 610.0 Sizing, Velocity

*Note: There are various hydraulic formulas for the flow of water in pipes. With high velocity and attendant turbulent flow, there can be excessive noise and piping wear.*

The designer should aim for maximum flow velocities in the range of five to eight feet per second to minimize noise and erosion problems. For the smallest tube sizes, the designer is wise to work at the bottom of this range, as a maximum, to guard against local high velocities building up due to faulty workmanship (e.g., burrs at tube ends which are not properly reamed) or unusually numerous changes in flow direction.

## GENERAL INFORMATION

It is not possible to cover all the variables of a plumbing system; however, the following information may prove helpful.

**Expansion Loops** – Copper tube, like all piping materials, expands and contracts with temperature changes. Therefore, in a copper tube system subjected to excessive temperature changes, the line tends to buckle or bend when it expands unless compensation is built into the system. Severe stresses on the joints may also occur. Such stresses, buckles, or bends are prevented by the use of expansion joints or by installing offsets, "U" bends, coil loops, or similar arrangements in the tube assembly.

These specially shaped tube segments take up expansion and contraction without excessive stress. The expansion of a length of copper tube may be calculated from the formula:

$$\frac{\text{Temperature Rise } (^\circ\text{F}) \times \text{Length (feet)} \times 12 \text{ (inches per foot)} \times \text{Expansion Coefficient (in. per in. per } ^\circ\text{F)}}{\text{Expansion (inches), or}}$$

$$\frac{\text{Temperature Rise } (^\circ\text{C}) \times \text{Length (meter)} \times 1000 \text{ (mm per meter)} \times \text{Expansion Coefficient (mm per mm per } ^\circ\text{C)}}{\text{Expansion (mm)}}$$

Calculations for expansion and contraction should be based on the average coefficient of expansion of copper, which is 0.0000094 per °F (1.692 x 10<sup>-5</sup> per °C), between 70°F (21°C) and 212°F (100°C). For example, the expansion of each 100 feet (3048 mm) of length of any size tube heated from room temperature (70°F) (21°C) to 170°F (77°C) [(a 100°F (38°C) rise)] is 1.128 inches (28.7 mm).

$$100^\circ \times 100 \text{ ft} \times 12 \text{ in./ft} \times 0.0000094 \text{ in./in./}^\circ\text{F} = 1.128 \text{ in., or}$$

$$55.6^\circ \times 30.48 \text{ m} \times 1000 \text{ mm/m} \times 1.692 \times 10^{-5} \text{ mm/mm/}^\circ\text{C} = 28.7 \text{ mm}$$

**Tube Supports**

**Vertical Piping**—See Section 314.0

**Horizontal Piping**—See Section 314.0

**Bending**

Copper tube, properly bent, will not collapse on the outside of the bend and will not buckle on the inside of the bend. Tests demonstrate that the bursting strength of a bent copper tube can be greater than it was before bending. Because copper is readily formed, expansion loops and other bends necessary in an assembly are quickly and simply made if the proper method and equipment are used. Simple hand tools employing mandrels, dies, forms, and fillers, or power-operated bending machines are used.

Both annealed tube and bending-temper tube can be bent with hand benders. The proper size bender for each size tube must be used. Usually the size of the tool corresponds to the nominal outside diameter of the tube, not the standard tube size. For a guide to the typical bend radii, see the following bending guide for copper tube.

**ADOPTED: 1969**

**REVISED: 1973, 1975, 1987, 1989, 1993, 2000**

**BENDING GUIDE FOR COPPER TUBE**

Tube Size, Inches (mm)	Tube Type	Temper	Minimum Bend Radius, Inches (mm)	Type of Bending Equipment
1/4 (6.4)	K, L	Annealed	3/4 (19.1)	Lever type
3/8 (9.5)	K, L, M	Annealed	1-1/2 (38) 3 (76)	Lever or gear type None; by hand*
		Drawn	1-3/4 (44)	Gear type
1/2 (12.7)	K, L, M	Annealed	2-1/4 (57) 4-1/2 (114)	Lever or gear type None; by hand*
		Drawn	2-1/2 (64)	Gear type
3/4 (19.1)	K, L	Annealed	3 (76)	Lever or gear type
			4-1/2 (114)	None; by hand*
	K, L	Drawn	6 (152)	None; by hand*
			3 (76) 4 (102)	Gear type Heavy-duty gear type
1 (25.4)	K, L	Annealed	4 (102) 7-1/2 (191)	Gear type None; by hand*
			9 (229)	None; by hand*

\* When bending by hand, without the use of bending equipment, a circular wooden disc is used. The radius of the disc should be about 1/4 to 1/2 inch less than the minimum bend radius shown.



**Installation Standard  
For  
TILE-LINED SHOWER RECEPTORS (and Replacements)**

**IAPMO IS 4-96**

This standard specification for the installation of tile-lined shower receptors is the result of extensive study and research by the following:

- Ceramic Tile Institute of America
- Associated Tile Contractors of Southern California, Inc.
- Tile Layers Local No. 18 of I.U.B.A.C, United States and Canada
- Tile Helpers Local No. 18 of I.U.B.A.C., United

States and Canada  
International Association of Plumbing and Mechanical Officials  
Job Problem and Technical Committee

**1. General**

**1.1 Inspection of Work** – All surfaces prepared by others shall be inspected by the tile installer before starting tile work, and all

**APPROVED CONSTRUCTION OF TILE-LINED SHOWER RECEPTORS  
STANDARD SPECIFICATION FOR THE INSTALLATION OF  
TILE-LINED SHOWER RECEPTORS**

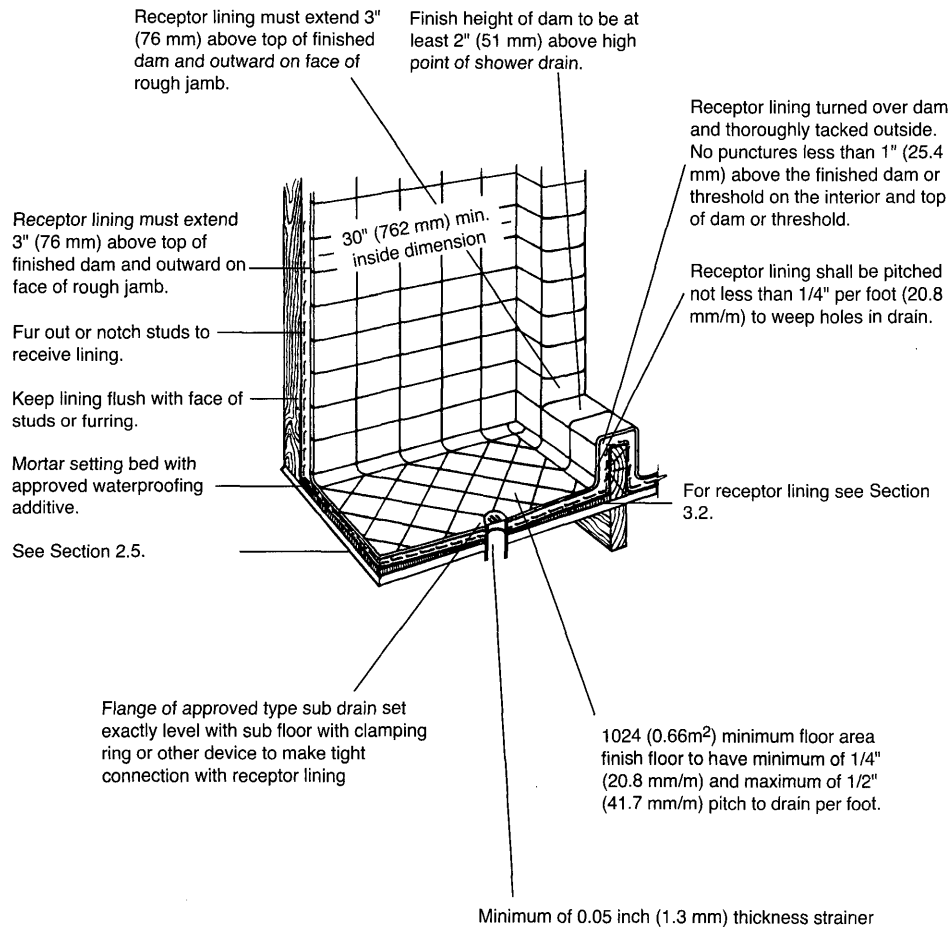



unsatisfactory conditions shall be reported to the Administrative Authority. Starting tile work by the tile installer shall be considered as acceptance of surfaces prepared by others.

- 1.2 Surface** – All surfaces to receive tile work shall be clean, structurally sound, and conform in every way to the local building code.

*Note: No tile work shall proceed until the pan and drain construction has been inspected and approved by the Administrative Authority, where required.*

## 2. Materials

- 2.1 Tile Quality and Grade** – Tile shall comply with American National Standard Specification for Ceramic Tile, A137.1 (equivalent to and incorporating U.S. Dept. of Commerce Simplified Practice Recommendation, R61-61, and Federal Specification SS-T-308b, Tile, Floor, Wall, and Trim Units, Ceramic), or CTI 69.5.
- 2.2 Cement** – Cement shall be portland cement type I or type II, conforming to ASTM C 150.
- 2.3 Sand** – Sand shall be damp, clean, and graded ASTM C-144.
- 2.4 Water** – Water shall be potable.
- 2.5 Reinforcing** shall be 2.5 lbs. per sq. yard (1.1 kg per m<sup>2</sup>) or greater galvanized metal lath conforming to ANSI A42.3 or 2 inches x 2 inches (51 mm x 51 mm), 16/16 gauge or 3 inches x 3 inches (76 mm x 76 mm) mesh, 13x 13 gauge or 1-1/2 inches x 2 inches (38 mm x 51 mm) mesh, 16 x 13 gauge steel wire conforming to ASTM A82 and A185.
- 2.6 Asphalt** shall conform to Federal Specification SS-A-0666, Type Z, Grade 2, Class A.
- 2.7 Plastic Roof Cement** shall conform to Federal Specifications SS-C-153.
- 2.8 Water-Resistant Felt Membrane** – The water-resistant felt membrane shall be at least 15 lb. (6.8 kg) asphalt saturated felt conforming to Type I, Federal Specification HH-F-191 (a).
- 2.9 Plastic Membrane** shall comply with applicable standards listed in Table 14-1 of the UPC.
- 2.10 Other Membranes** – Where the Administrative Authority approves their use, non-metallic sub-pans or linings or lead sheets weighing not less than 4 lbs. per sq. foot (191.5 Pa) and

copper pans of at least No. 24 B & S gauge (Brown & Sharp 0.0201 inches) or greater in thickness may be used.

- 2.11 Waterproofing Admixture** – The mortar bed of the receptor shall be mixed with a waterproof admixture approved by the Administrative Authority in the amounts allowed by such approval.

## Currently Approved Mortar Additives

Anti-Hydro—1 qt. (0.95 I) per sack of cement

Plastiment—1 lb. (0.5 kg) of powder per sack of cement

Plastiment—2 oz. (56.7 g) of fluid per sack of cement

Sika 3A—1 qt. (0.95 I) per sack of cement

Suconem (Red Label)—1 pint (0.47 I) per sack of cement

## 3. Installation

- 3.1 Shower Drains** – An approved type shower floor drain with sub-drain shall be installed with every such shower membrane. Flange of each sub-drain shall be accurately set exactly level with sloping sub-floor and shall be equipped with a clamping ring or other approved device to make a tight connection between the membrane and the sub-drain. The sub-drain shall have weep holes into the waste line. The weep holes located in the sub-drain clamping ring shall be protected from becoming clogged during the placement of finish materials. The drain shall be of such design that there will be not less than 2" (51mm) depth from the top of the sub-drain flange to top of the strainer. Unless otherwise approved by the Administrative Authority, drains shall be located in the approximate center of the shower area.
- 3.2 Sloping Sub-Floor and Shower Membrane** – All lining materials shall be pitched one quarter (1/4) inch per foot (20.8 mm/m) to weep holes in the sub-drain by means of a smooth and solidly formed sloping sub-base. All such lining materials shall extend upward on the sidewalls and rough jambs of the shower opening to a point not less than three (3) inches (76 mm) above the top of the finished dam or threshold and shall

extend outward over the top of the rough threshold and be turned over and fastened on the outside face of both the rough threshold and the jambs.

**3.2.1** Non-metallic shower sub-pans or linings may be built-up on the job site of not less than three (3) layers of standard grade fifteen (15) pound (6.8 kg) asphalt-impregnated roofing felt. The bottom layer shall be fitted to the formed sub-base and each succeeding layer thoroughly hot-mopped to that below, with hot asphalt conforming to Fed. Spec. SS-A0666, Type Z, Grade 2, Class A on the basis of twenty (20) pounds (9.1 kg) of asphalt per layer per square. All corners shall be carefully fitted and made strong and watertight by folding or lapping. Each corner shall be reinforced with suitable webbing hot-mopped in place. All folds, laps, and reinforcing webbing shall extend at least four (4) inches (102 mm) in all directions from the corner, and all webbing shall be of approved type and mesh, producing a tensile strength of not less than fifty (50) pounds per square inch (344.5 kPa per square meter) in either direction.

**3.2.2** Non-metallic shower sub-pans or linings may also consist of a single layer or multilayers of other approved equivalent material, suitably reinforced and carefully fitted in place on the job site, as required elsewhere in this section, according to manufacturer's recommended installation procedures.

Where flexible plastic sheet membranes are used, corners shall be carefully constructed by folding or bonding of pre-fabricated reinforcing corners. Joints in flexible plastic sheeting shall be constructed with the appropriate solvent bonding liquid, bodied solvent cement, or thermal welding.

**3.2.3** Where lead and copper pans are used as membranes, the installation shall be made in similar manner as required for felt membranes, except the asphalt moppings. In addition the pans shall be insulated from all concrete and mortar surfaces and from all conducting substances other than their connecting drain by 15 lb. (6.8 kg) asphalt saturated felt or an approved equivalent hot mopped to the lead or copper pan. Joints in lead and copper pans shall not be soldered, but shall be burned or silver brazed, respectively.

**3.2.4** All linings shall be properly recessed and fastened to approved backing so as not to occupy the space required for the wall covering and shall not be nailed or perforated at any point which will be less than one (1) inch (25.4 mm) above the finished dam or threshold.

**3.3 Tests** – Upon installation, all linings shall be tested for watertightness by being filled to the top of the rough threshold with water for a period of time sufficient to establish their watertightness. (Usually twenty-four (24) hours with no loss of water. See the local Administrative Authority for exact time limit.) A test plug shall be so placed that both the upper and under sides of the lining shall be subjected to test at its point of contact with the sub-drain. When the test plug is removed, all of the test water shall drain out by gravity through the weep holes. A ring of non-absorbent material must be placed around the weep holes to keep them open when the finish materials are installed.

**3.4 Receptor** – Shower floor shall be of ceramic tile set in portland cement mortar mixed in the proportion of one (1) part portland cement to four (4) parts of mortar sand by volume and shall be provided with an approved shower drain designed to make a watertight joint at the floor. The mortar mixture shall be of such consistency that a troweled surface readily assumes a smooth screeded surface. All concrete mortar bases shall be mixed with an approved waterproofing admixture and properly reinforced with 2.5 lbs. per square yard (1.1 kg per square m) or more galvanized metal lath or 2 inch x 2 inch (51 mm x 51 mm), 16/16 gauge 3 inch x 3 inch (76 mm x 76 mm) mesh, 13 x 13 gauge or 1-1/2 inch x 2 inch (38 mm x 51 mm) mesh, 16 x 13 gauge cold drawn welded steel wire fabric located in the approximate center of the mortar bed and extending at least 3 inches (76 mm) at any point. The finished floor shall be not less than 2 inches (51 mm) measured from the top surface of the membrane. The high point of the tile floor shall be not less than 2 inches (51 mm) or more than 9 inches (229 mm) below the top of the finished dam and shall have a minimum of 1/4 inch (6.4 mm/m) and a maximum of 1/2 inch (19.1 mm/m) pitch per foot toward the drain. Shower walls to a minimum height of 3 inches (76 mm) and not less than 1 inch (25.4 mm) above the finished dam shall be lined with ceramic tile set in portland cement mortar.

**Exception:** Special-use shower compartments for wheelchair use may eliminate the curb or threshold. The required slope and depth shall be maintained from the door or entry to the drain opening.

The minimum distance between the door or entry to the drain opening shall be 4 feet (1219 mm).

- 3.5** Floors of public shower rooms shall have a nonskid surface and shall be drained in such a manner that waste-water from one bather will not pass over areas occupied by other bathers. Gutters in public or gang shower rooms shall have rounded corners for easy cleaning and shall be sloped not less than two (2) percent toward drains. Drains in such gutters shall be spaced not more than eight (8) feet (2438 mm) from side walls or more than sixteen (16) feet (4877 mm) apart.
- 3.6** Shower walls, including shower walls over bathtubs, shall be constructed of dense, nonabsorbent waterproof materials such as ceramic tile set in portland cement mortar or approved cementitious backer unit when no materials are adversely affected by moisture to a height of not less than six (6) feet (1829 mm) above the floor.

#### Replacement Requirements

##### 4. Purpose

- 4.1** The purpose of this section is to provide the necessary criteria for the installation of those shower liners which have been found necessary to be replaced.

##### 5. Scope

- 5.1** Those requirements listed in Section 6, Replacement Modifications, will prevent the unnecessary removal of tile if compliance with the Code requirements for new work were followed.
- 5.2** Requirements for replacement liners that are not necessary in new installations, which shall be properly complied with, are listed in 7, Additional Requirements for Replacements.

##### 6. Replacement Modifications

- 6.1** Top of lining may be lower than three (3) inches (76mm) on interior wall surfaces, but in no case shall it be lower than one (1) inch (25.4 mm) above the top of the rough dam.

The lining shall be sealed to the existing sound tile. (See the manufacturer's recommendations for the proper sealant.)

- 6.2** Lining need not be turned down and fastened outside the rough threshold and jamb, but it shall be sealed to the existing sound mortar. (See manufacturer's recommendations for proper sealant.)
- 6.3** When existing sound tile is lower than three (3) inches (76 mm) on the jambs, the membrane shall be sealed tight to that sound tile. In no case shall the membrane turn up and be sealed to the sound tile less than three-quarters (3/4) inch (19.1 mm) above the rough threshold.
- 6.4** If there is room for a minimum of one-half (1/2) inch (12.7 mm) of mortar plus the thickness of the tile on the vertical walls, the lining does not have to be recessed flush to the studs.

#### 7. Additional Requirements for Replacements

- 7.1** Flashing behind the existing sound tile work and over the top of the new lining. Flashing is to be fifteen (15) pound (6.8 kg) felt or equivalent, backed up with wire mesh for stiffness to hold it in place. (See Figure 2.) Flashing shall be cut to fit between the studs and behind the existing sound tile and large enough to nail securely to the studs prior to installing the replacement tile.
- 7.2** There must be a continuous bead of caulking between existing mortar and the replacement mortar bed.

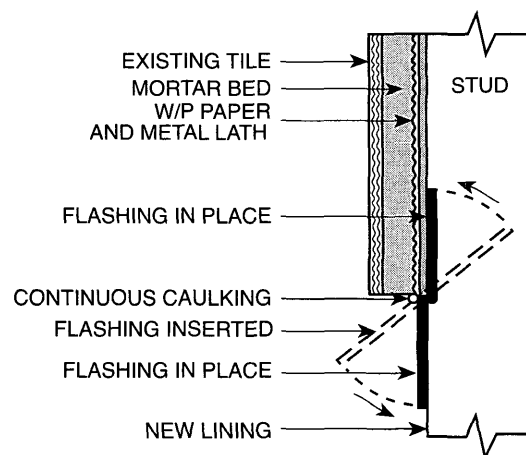

Figure 2

ADOPTED: 1966

**Installation Standard  
For  
ABS BUILDING DRAIN, WASTE, AND VENT PIPE AND FITTINGS**

**IAPMO IS 5-92**

This installation standard shall apply to ABS building drain, waste, and vent systems as governed by the Uniform Plumbing Code. Material Standard ASTM D2661-85a, Standard Specification of Acrylonitrile-Butadiene-Styrene (ABS) Plastic Drain, Waste and Vent Pipe and Fittings, or ASTM F628-85, Acrylonitrile-Butadiene-Styrene (ABS) Schedule 40 Plastic, Drain, Waste and Vent Pipe with a Cellular Core, shall form a part of this standard.

Installation, material, and inspection shall comply with this standard and the current edition of the Uniform Plumbing Code as published by the International Association of Plumbing and Mechanical Officials and shall also comply with this standard.

*Note: The Building Official shall be consulted about penetration of fire separations, height and area or other limitations.*

*Note: The following sections of the Uniform Plumbing Code apply.*

202.0	Definition ABS
Table 14-1	Pipe and Fittings
	ASTM D2661-94a D3311-92*
	ASTM D2122-90 F402-93
	ASTM F628-93
301.1	Minimum Standards
704.4	Closet Flanges
707.1	Cleanout Fittings
311.8	Screwed, Fittings
310.0	Workmanship
311.0	Prohibited Fittings and Practices
101.4.1.1	Repairs and Alterations
313.0	Protection of Piping, Materials, and Structures
314.0	Hangers and Supports (Vertical Piping)
314.0	Hangers and Supports (Horizontal Piping)
103.5	Inspection
723.0	Testing
701.0	Materials (Drainage)
903.0	Materials (Venting)

903.4	Straining or Bending Pipe
1003.0	Traps Described
316.1.1	Threaded Joints
316.1.5	Type of Joints – Solvent Cement Plastic Pipe Joints
316.2.3	Special Joints
316.3.1	Flanged Fixture Connections
316.4	Prohibited Joints and Connections
317.0	Increases and Reducers
1101.3	Materials Uses

**ABBREVIATIONS**

ASTM	American Society for Testing and Materials
IAPMO	International Association of Plumbing and Mechanical Officials
UPC	Uniform Plumbing Code

**301.1 Minimum Standards**

**301.1.1 Pipe**

ABS pipe is furnished in straight lengths. The pipe is black in color. The pipe wall is the same thickness as that of Schedule 40 (IPS) standard steel pipe. Pipe shall be marked on two sides, 180° apart or spirally, in letters not less than 3/16 inch (4.8 mm) high in a contrasting color and shall contain at least the following, at not more than two (2) feet (610 mm) intervals:

- (a) Manufacturer's name or trademark;
- (b) ASTM designation;
- (c) Nominal pipe size;
- (d) Symbol ABS-DWV or COEX ABS FOAMED CORE DWV;
- (e) Products listed by IAPMO that are covered by this standard shall be labeled with the designated IAPMO certification mark to show compliance with this standard;
- (f) Manufacturer's code; and
- (g) Any other marking required or permitted by law.

\*Although referenced in this standard, some of the fittings shown in the standard are not acceptable under the Uniform Plumbing Code.

**301.1.2 Fittings**

Fittings are black. Refer to tables in ASTM D2661-85a and D3311-82 for dimensions and tolerances for pipe, fitting sockets, and laying lengths.

Fittings shall be marked on the body or hub on both sides. The markings shall consist of at least the following:

- (a) Manufacturer's name or trademark;
- (b) Symbol ABS-DWV;
- (c) Products listed by IAPMO that are covered by this standard shall be labeled with the designated IAPMO certification mark; and
- (d) Any other markings required or permitted by law.

**301.1.3 Solvent Cement**

Solvent cement shall be as specified in ASTM Standard D2235-81. Solvent cement labels shall contain at least the following:

- (a) Manufacturer's or supplier's name and address, tradename, trademark, or both;
- (b) Cement for ABS (pipe and fittings);
- (c) ASTM designation D2235;
- (d) Lot number;
- (e) Recommended procedure for use and safety precautions;
- (f) Products listed by IAPMO that are covered by this standard shall be labeled with the designated IAPMO certification mark; and
- (g) Any other markings required or permitted by law.

**310.0 Workmanship****310.1 Alignment**

All piping system components shall be aligned properly without strain. Pipe shall not be bent or pulled into position. Vertical piping shall be maintained in alignment between floors with midstory guides. Pipe and fittings shall be so positioned that identifying markings shall be readily visible for inspection.

**313.0 Protection of Piping****313.1 Storage**

Pipe and fittings should not be stored in

direct sunlight. However, exposure to direct sunlight during normal construction periods is not considered harmful. Pipe shall be stored in such a manner as to prevent sagging or bending.

**313.2 Expansion And Contraction**

Thermal expansion and contraction of plastic drain waste and vent systems shall be taken into consideration. Thermal expansion and contraction may be controlled by several methods offset, expansion joints, or restraints. Regardless of method utilized, certain conditions shall be met:

- (a) Support, but do not rigidly restrain piping at changes of direction.
- (b) Do not anchor pipe rigidly in walls.
- (c) Holes through framing members must be adequately sized to allow for free movement.

DWV installations with frequent changes in direction will compensate for thermal expansion and contraction. Expansion joints may be utilized in vertical straight runs in excess of thirty (30) feet (9144 mm) provided they are installed per manufacturer's installation instructions.

Except piping buried below ground, horizontal and vertical piping should be installed with restraint fittings or a minimum twenty-four (24) inches (610 mm) 45° offset every thirty (30) feet (9144 mm).

Thermal expansion for installations subject to temperature changes may be determined from Table 3-1.

The linear expansion shown is independent of the diameter of the pipe.

**313.3 Exposed Piping**

Piping shall not be exposed to direct sunlight.

*Exception: Vent piping through roof. Plumbing vents through roof, exposed to sunlight, shall be protected by water base synthetic latex paints. Adequate support shall be provided where ABS piping is exposed to wind, snow and ice loading.*

**313.4 Protection From Damage**

Piping passing through wood studs or plates shall be protected from puncture by a minimum 1/16 inch (1.6 mm) thick

**TABLE 3-1  
Thermal Expansion Table**

Chart Shows Length Changes in Inches vs. Degrees Temperature Change  
Coefficient of Linear Expansion:  $e = 5.5 \times 10^{-5}$  in/in °F

Length (feet)	40°F	50°F	60°F	70°F	80°F	90°F	100°F
20	0.536	0.670	0.804	0.938	1.072	1.206	1.340
40	1.070	1.340	1.610	1.880	2.050	2.420	2.690
60	1.609	2.010	2.410	2.820	3.220	3.620	4.020
80	2.143	2.680	3.220	3.760	4.290	4.830	5.360
100	2.680	3.350	4.020	4.700	5.360	6.030	6.700

**TABLE 3-1 (Metric)  
Thermal Expansion Table**

Chart Shows Length Changes in Millimeters vs. Degrees Temperature Change  
Coefficient of Linear Expansion:  $e = \frac{0.3 \text{ mm}}{\text{mm } ^\circ\text{C}}$

Length (mm)	4°C	10°C	16°C	21°C	27°C	32°C	38°C
6096	13.6	17.0	20.4	23.8	27.2	30.6	34.0
12192	27.2	34.0	40.8	47.8	52.1	61.5	68.3
18288	40.9	51.1	61.2	71.6	81.8	92.0	102.1
24384	54.4	68.1	81.8	95.5	110.0	122.7	136.1
30480	68.1	85.1	102.1	119.4	136.1	153.2	170.2

Example:

Highest Temperature expected 100°F (38°C)  
Lowest Temperature expected 50°F (10°C)  
50°F (10°C)

Length of run – 60 feet (18288 mm) from chart, read 2.010 inches (51 mm) linear expansion that must be provided for.

**313.5**

**Anti-Freeze Protection**

ABS pipe and traps can be protected from freezing by the use of one of the following solutions or mixtures:

- (a) 4 quarts (3.8 liters) of water mixed with 5 quarts (4.8 liters) of glycerol,
- (b) 2-1/2 lbs. (1.1 kg) of magnesium chloride dissolved in one gallon (3.8 liters) of water, or
- (c) 3 lbs. (1.4 kg) of table salt dissolved in one gallon (3.8 liters) of water.

The salt solutions are effective to approximately 10°F (-12°C). If lower temperatures are anticipated, the pipe should be drained, or the glycerol solution should be used.

**313.6**

**Piping Installed in Fire-Resistive Construction**

Where piping is installed and penetrates required fire-resistive construction, the fire-resistant integrity of the construction shall be as required by the Administrative Authority, or, when not established by the building code, by qualified testing methods approved by the Administrative Authority. Approval shall be obtained prior to installing any such piping.

**314.0**

**Hangers and Supports**

**314.1**

**Abrasion**

Hangers and straps shall not compress, distort, cut, or abrade the piping and shall allow free movement of pipe. Pipe

- exposed to damage by sharp surfaces shall be protected.
- 314.2 Support**  
Support all piping at intervals of not more than four (4) feet (1219 mm), at end of branches, and at change of direction or elevation. Supports shall allow free movement but shall restrict upward movement of lateral runs so as not to create reverse grade. Vertical piping shall be supported at each story or floor level. Alignment of vertical piping shall be maintained between floors with the use of a midstory guide. Support trap arms in excess of three (3) feet (914 mm) in length as close as possible to the trap. Closet rings shall be securely fastened with corrosion-resistant fasteners to the floor, with top surface one-quarter (1/4) inch (6.4 mm) above finish floor.
- 701.0 Materials, Drainage—Deleted**
- 903.0 Materials, Vent—Deleted**
- 1003.0 Traps**  
**1003.1 Connection to Metal Traps**  
Traps shall be connected by means of listed threaded trap adapters.
- 705.0 Joints**  
**705.1 Caulked Joints**  
Make connections or transitions to bell-and-spigot cast-iron soil pipe and fittings, and to bell-and-spigot pipe and fittings of other materials with listed mechanical compression joints designed for this use, or with caulked joints made in an approved manner. In caulking, pack the joint with oakum or hemp and fill with molten lead to a depth of not less than (1) inch (25.4 mm). Allow a period of four (4) minutes for cooling. After cooling, caulk the lead at the inside and outside edges of the joint. Lead shall not be overheated. Heat lead to melting point only.  
**Note:** Caulked joints should be avoided if possible.
- 316.0 Solvent Cement Joints**  
**316.1 Selection.** Solvent cement shall be recommended for ABS by the manufacturer. Follow manufacturer's recommendations for types of solvent cement for such conditions as temperature over 100°F (38°C), or humidity over 60 percent.
- 316.1.1 Handling (to maintain effectiveness).**  
Solvent cement containers no larger than 1 quart (1 liter) should be used in the field (to avoid thickening due to evaporation). Keep container closed and in the shade when not in use. Keep applicator submerged in solvent cement between applications. When solvent cement becomes thicker, THROW IT AWAY. Solvent cement must NOT be thinned.
- 316.1.2 Size of Applicator.** Applicator should be about one-half the pipe diameter. Do not use small applicators on large pipes. Ordinary pure bristle paint brush or applicators furnished with product are satisfactory.
- 316.1.3 Application.** Solvent cement shall be applied deliberately but without delay (two men may be needed to make large joints). Use special care when temperature is over 100°F (38°C) or humidity is over 60 percent.
- 316.1.4 Procedure**  
**XI Safety Requirements and Precautions**  
**XI.1 General.** Solvents contained in ABS plastic pipe cements are classified as airborne contaminants and flammable and combustible liquids. Precautions listed in this appendix should be followed to avoid injury to personnel and the hazard of fire.
- XI.2 Safety Precautions**  
**XI.2.1** Prolonged breathing of solvent vapors should be avoided. When pipe and fittings are being joined in partially enclosed areas, a ventilating device should be used in such a manner as to minimize the entry of vapors into the

breathing areas.

- XI.2.2** Solvent cements should be kept away from all sources of ignition, heat, sparks, and open flame.
- XI.2.3** Containers for solvent cements should be kept tightly closed except when the cement is being used.
- XI.2.4** All rags and other materials used for mopping up spills should be kept in a safety waste receptacle which should be emptied daily.
- XI.2.5** Most of the solvents used in ABS pipe cements can be considered eye irritants, and contact with the eye should be avoided for it may cause eye injury. Proper eye protection and the use of chemical goggles or face shields is advisable where the possibility of splashing exists in handling solvent cements. In case of eye contact, flush with plenty of water for 15 minutes and call a physician immediately.
- XI.2.6** Repeated contact with the skin should be avoided. Proper gloves impervious to and unaffected by the solvents should be worn when frequent contact with the skin is likely. Application of the solvents or solvent cements with rags and bare hand, is not recommended. Brushes and other suitable applicators can be used effectively for applying the solvent cement, thus avoiding skin contact. In the event of excessive contact, remove contaminated clothing and wash skin with soap and water.
- Step 1** Cut pipe square with hand saw and miter box, mechanical cutoff, saw, or tube cutter designed for plastic.
- Step 2** Ream inside and chamfer outside of pipe to eliminate all burrs.
- Step 3** Clean all dirt, moisture, and grease from pipe and socket.

Use a clean, dry rag.

- Step 4** Check dry fit of pipe in fitting. Pipe should enter fitting socket from 1/3 to 3/4 depth of socket.
- Step 5** Apply a light coat of ABS solvent cement to inside of socket using straight outward strokes (to keep excess solvent out of socket). This is also to prevent solvent cement damage to pipe. For loose fits, apply a second coat of solvent cement. Time is important at this stage. See Section 316.1.3.
- Step 6** While both the inside socket surface and the outside surface of the pipe are SOFT and WET with solvent cement, forcefully bottom the pipe in the socket, giving the pipe a one-quarter turn, if possible. The pipe must go to the bottom of the socket.
- Step 7** Hold the joint together until tight (partial set).
- Step 8** Wipe excess cement from the pipe. A properly made joint will normally show a bead around its entire perimeter. Any gaps may indicate insufficient cement or the use of light-bodied cement on larger diameters where heavy-bodied cement should have been used.
- Step 9** The system shall not be tested until the joints have cured (set) at least as long as recommended by the manufacturer.

### 316.1.5

#### Threaded Joints

Listed adapter fittings shall be used for the transition to threaded connections. No threaded female ABS fitting(s) or joint(s) shall be located in a non-accessible location. The joint between the ABS pipe and adapter fitting shall be of the solvent cement type.

Only listed thread tape or thread lubricant specifically intended for use with plastics shall be used. Conventional pipe compounds, putty, linseed oil-based products, and unknown mixtures shall be removed and replaced with new materials. Where a threaded joint is made, obtain tightness by maxi-



mum hand tightening plus additional tightening with a strap wrench not to exceed one full turn.

**316.2.3 Special Joints**

**316.2.3.1 Connection To Non-Plastic Pipe**

When connecting plastic pipe to other types of piping, use only listed fittings and adapters designed for the specific transition intended.

**316.4 Prohibited Fittings and Connections**

**(A) Drainage system** – Any fitting or connection which has an enlargement, chamber, or recess with a ledge, shoulder, or reduction of pipe area that offers an obstruction to flow through the drain is prohibited.

**(B)** No fitting or connection that offers abnormal obstruction to flow shall be used. The enlargement of a three (3) inch (76 mm) closet bend or stub to four (4) inches (102 mm) shall not be considered an obstruction.

**ADOPTED: 1966**

**REVISED: 1971, 1974, 1975, 1976, 1977, 1981, 1982, 1983, 1987, 1989, 1990, 1992**

**Installation Standard  
For  
HUBLESS CAST-IRON SANITARY AND RAINWATER SYSTEMS**

**IAPMO IS 6-2000**

**1.0 SCOPE**

- 1.1** This installation standard is for use with listed systems of hubless cast iron pipe and fittings, utilizing listed couplings.
- 1.2** This standard shall serve to supplement any existing applicable standards and requirements of appropriate codes and laws regulating use of hubless cast iron pipe and fittings in building sewer, drainage, waste, vent, and rainwater systems, and to provide the necessary requirements for installation, use and inspection of piping and fittings for this purpose. This system may be used in any location where cast-iron pipe is acceptable under the Uniform Plumbing Code.
- 1.3** The provisions of this standard are not intended to prevent the use of any alternate material or method of construction, provided it meets the requirements of the standard.

1101.11 Roof Drainage  
Table 14-1 Plumbing Material Standards

**2.0 PRODUCT REQUIREMENTS**

**2.1 Minimum Standards**

Hubless pipe, fittings and couplings shall be manufactured in strict compliance with appropriate standards acceptable to IAPMO. [UPC 301.1]

**2.2 Markings**

**2.2.1** All hubless system components shall be clearly marked with the following:

- (a) Manufacturer's name or manufacturer's registered trademark; the markings shall be adequate to readily identify the maker or manufacturer to the end user of the product;
- (b) Products listed by IAPMO that are covered by this standard shall be labeled with the designated IAPMO certification mark;
- (c) Country of origin; and
- (d) Any other markings required by law.

**2.2.2** Pipe shall be legibly and continuously marked along the full length of the barrel. [UPC 301.1.2]

**2.2.3** Markings on fittings shall be cast raised letters and not be located in the W dimension as found in the product standard. With the exception of the fittings with notations in the standards allowing for optional positioning lugs fittings have a raised lug. When properly positioned, the gasket in other than wider body couplings will rest against but will not cover the lug. Gaskets for wider body couplings will cover the lug. [UPC 301.1.2]

**2.3** All installations shall be made so that the components can be readily identified. When laying hubless pipe in a ditch, the identification shall be on the top side of the pipe. When in walls, the identification shall be on a side readily visible to the inspector.

**Note:** The following sections of the Uniform Plumbing Code apply to this standard:

- 101.4.1.1 Repair and alterations
- 301.1 Minimum Standards (Material)
- 310.0 Workmanship
- 311.0 Prohibited fittings and practices
- 313.0 Protection of piping materials and structures
- 314.0 Hangers and Supports
- 316.4 Prohibited joints and connections
- 317.0 Increases and reducers
- Table 3-1 Hanger Rod Sizes
- Table 3-2 Support Spacing
- 701.0 Materials (Drainage)
- 704.4 Closet Flanges
- 705.1 Type of joints
- 705.3.2 Expansion Joints
- 707.14 Cleanout Plugs
- 712.2 and 712.3 Testing
- Table 7-3 Sizing
- Table 7-5 Sizing
- 903.0 Materials (Venting)
- 1003.0 Traps Described
- Chapter 11 Storm Drainage
- 1101.3 Materials Uses

**2.4 Workmanship**

All piping systems shall be installed and supported in a workmanlike manner. [UPC 310.0]

**2.5 Hangers and Supports**

Support and stability of all components of a hubless cast iron sanitary and rainwater system shall be given prime consideration. [UPC 314.0]

**2.5.1** Vertical hubless systems shall be supported per Table 3-2 of the Uniform Plumbing Code.

**2.5.2** Horizontal hubless systems shall be supported per Table 3-2 of the Uniform Plumbing Code. Supports shall be adequate to maintain alignment and prevent sagging and shall be placed within eighteen (18) inches (457 mm) of the joint.

**2.5.3** Joints shall be supported at least at every other joint except that when the developed length between supports exceeds four (4) feet (1219 mm) they shall be provided at each joint. Supports shall also be provided at each horizontal branch connection. Such support shall be placed immediately adjacent to the coupling.

**2.5.4** Suspended lines shall be suitably braced to prevent horizontal movement.

**2.5.5** Closet bends, trap arms and similar branches shall be secured against movement in any direction.

**2.5.6** Hubless systems, in the ground shall be laid on a firm bed for its entire length except where support is otherwise provided which is adequate in the judgement of the Administrative Authority. [UPC 314.3] Vertical sections and their connecting branches shall be adequately staked and fastened to driven steel pipe or reinforcing bars so as to remain stable while backfill is placed or concrete is poured.

**2.6 Joints**

During installation assembly, hubless pipe and fittings shall be inserted into the gasket and firmly seated against a center stop. Center stop ring or fittings shall not create an enlargement chamber or recess with a ledge, shoulder or reduction of pipe area or offer an obstruction to flow. In order to provide a sound joint with field cut lengths of pipe, the ends shall be cut square. Coupling assemblies shall be

properly positioned and uniformly tightened to the torque required by IAPMO listing. The use of an adequate torque wrench recommended by the manufacturer of the coupling assemblies shall be used. [UPC 705.1]

**2.6.1** Listed adapters designed for the specific transition intended shall be used for the intermembering transition of different piping materials.

**2.6.2** The connection of closet rings, floor and shower drains and similar "slip over" fittings to hubless pipe and fittings and the connection of hubless pipe and fittings to conventional pipe hubs shall be accomplished by the use of caulked lead joints, or other listed connections.

**ADOPTED: 1966**

**REVISED: 1972, 1974, 1975, 1982, 1989, 1991, 1993, 1995, 2000, 2003**

**Installation Standard  
For  
POLYETHYLENE (PE) COLD WATER BUILDING SUPPLY AND YARD PIPING**

**IAPMO IS 7-90**

This standard shall govern the installation of polyethylene (PE) cold water building supply and yard piping. (See Section 604.1 of the Uniform Plumbing Code and Section 609.2 of this standard for allowable location and pressure.) Installation, material, and inspection shall comply with this standard and the current edition of the Uniform Plumbing Code published by the International Association of Plumbing and Mechanical Officials and shall also comply with this standard.

*Note: The following sections of the Uniform Plumbing Code apply to polyethylene piping.*

- 202.0 Definition of PE
- Table 14-1 Fittings (and fasteners) for joining PE pipe IAPMO PS 25-84  
Plastic insert fittings for Polyethylene (PE) Plastic Pipe  
ASTM D2609-93  
PE Pipe ASTM D2239-93
- 310.0 Workmanship
- 313.0 Protection of Piping, Materials, and Structures
- 314.0 Supporting in the Ground
- 315.0 Backfilling
- 316.2.3 Connection to Other Materials
- Chapter 6 Water Distribution
- 604.1 Location
- 609.1 Depth of piping
- 609.3
- 103.5.4.2 and
- 103.5.3.3 Testing

**Chapter 2 Definitions**

Chapter 14

- ASTM American Society for Testing and Materials
- IAPMO International Association of Plumbing and Mechanical Officials
- NSF National Sanitation Foundation
- PS Material and Property Standard published by IAPMO

UPC Uniform Plumbing Code published by IAPMO

- 301.1 Minimum Standards**
- 301.1.1 Material.** Material shall conform to the appropriate standard in Table 14-1. See note ahead of Chapter 2 of this standard.
- 301.1.1.1 Pipe.** PE pipe is plastic and black.
- 301.1.1.2 Fittings.** Fittings are copper alloy or nylon-barbed insert fittings.
- 301.1.2 Markings**
- 301.1.2.1 Piping.** Pipe shall be marked at intervals of not more than five (5) feet (1524 mm) with at least the following:
  - (a) Manufacturer's name or trademark;
  - (b) ASTM D2239;
  - (c) Pipe size;
  - (d) PE 3406 or PE 3408;
  - (e) Pressure rating of SDR 7 - PE 3406 (160 psi/1.10 mPa) and PE 3408 (200 psi/1.38 mPa);
  - (f) NSF seal or marking of other acceptable agency; and
  - (g) Pipe listed by IAPMO that is covered by this standard shall be labeled with the UPC logo to show compliance with this standard.
- 301.1.2.2 Fittings.** Fittings shall be marked with at least the following:
  - (a) Manufacturer's name or trademark;
  - (b) Size; and
  - (c) Fittings listed by IAPMO that are covered by this standard shall be labeled with the UPC logo to show compliance with this standard.
- 301.1.2.3 Bands.** Bands shall be marked with at least the following:
  - (a) Manufacturer's name or trademark;
  - (b) Model;
  - (c) Stainless steel, Series 300; and
  - (d) Bands listed by IAPMO that are covered by this standard shall be labeled with the UPC logo to show compliance with this standard.

**301.1.3 Position of Markings.** The identifying markings on pipe and fittings shall be visible for inspection without moving materials.

### 313.0 Protection of Piping

**313.1 Storage.** Unprotected pipe should not be stored in direct sunlight. The pipe shall be stored in a way to protect it from mechanical damage (slitting, puncturing, etc.).

**313.2 Thermal Expansion.** The pipe shall be snaked in the trench bottom with enough slack to provide for thermal expansion and contraction. The normal slack created by residual coiling is generally sufficient for this purpose. If, however, the pipe has been allowed to straighten before it is placed in the trench, six (6) inches (152 mm) per one hundred (100) feet (30,480 mm) of length shall be allowed for this purpose.

**313.3 Exposed Piping.** Vertical piping may extend a maximum of twenty-four (24) inches (610 mm) above grade when located on the exterior of the building or structure and protected from mechanical damage to the satisfaction of the Administrative Authority. Where exposed to sunlight, the pipe shall be wrapped with at least 0.040 in. (1.02 mm) of tape.

### 315.0 Trenching and Cover

**315.1** Trench bottoms shall be uniformly graded and shall be of either undisturbed soil or shall consist of a layer or layers of compacted backfill so that minimum settlement will take place.

### 316.1 Joints

**316.1.1 Procedure.** Polyethylene pipe joints shall be made as follows (see Section 301.1.1):

- Step 1 Cut pipe square using a cutter designed for plastic pipe, and chamfer ends to remove sharp edges.
- Step 2 Place two strap-type stainless steel bands over the pipe.
- Step 3 Check that fittings are properly sized for pipe, as tubing fittings are not of proper size.

Step 4 Force the end of the pipe over the barbed insert fittings, making contact with the fitting shoulder (the end of the pipe may be softened by placing in hot water).

Step 5 Position the clamps 180° apart, and tighten evenly, so as to make a leakproof joint.

**316.1.2 Other Joints.** Polyethylene pipe shall not be threaded. Joints made with adhesives or solvent cementing techniques are prohibited.

### 604.0 Materials

**604.1 Location.** Polyethylene piping shall be installed only outside the foundation of any building or structure or parts thereof. It shall be buried in the ground for its entire length, except that vertical piping may be extended above grade per Section 313.3. It shall not be installed within or under any building, structure, mobile home, commercial coach, or parts thereof. The term building or structure or parts thereof shall include structures such as porches and steps, whether covered or uncovered, roofed porte cocheres, roofed patios, carports, covered walks, covered driveways, and similar structures or appurtenances.

**604.2 Harmful Materials.** Polyethylene that has been in contact with gasoline, lubricating oil, or aromatic compounds shall not be installed.

### 609.0 Installation

**609.1 Pipe.** Kinked pipe shall not be used. PE pipe shall not be flared.

**609.2 Fittings.** Compression-type couplings and fittings shall be used only when installing one and one-half (1-1/2) inch (38 mm) and larger pipe. Stiffeners that extend beyond the clamp or nut shall not be used.

**609.3 Bends.** Changes in direction may be made by bends. The installed radius of pipe curvature shall be not less than thirty (30) pipe diameters or the coil radius when bending with the coil. Coiled pipe shall not be bent beyond

POLYETHYLENE (PE) COLD WATER BUILDING  
SUPPLY AND YARD PIPING

IS 7

straight. Bends shall not be permitted  
loser than ten (10) pipe diameters of any  
fitting or valve.

**609.4 Maximum Working Pressure.**

Working pressure shall not exceed 160  
psi (1.10 mPa).

**609.5 Identification.** A label shall be fastened  
to the main electric meter panel stating  
"This structure has a non-metallic water  
service."

**610.0 Sizing**

**610.1** Piping shall be sized in accordance with  
UPC Section 610.0. When UPC  
Appendix A is applicable, use UPC  
Chart A-4 (Copper Tubing Type L).  
Flow velocity shall not exceed 8 fps (2.4  
m/s).

**ADOPTED: 1968**

**REVISED: 1969, 1971, 1972, 1973, 1975, 1978,  
1981, 1982, 1983, 1989, 1990**



**Installation Standard  
For  
PVC COLD WATER BUILDING SUPPLY AND YARD PIPING**

**IAPMO IS 8-95<sup>e1</sup>**

This standard shall govern the installation of PVC piping with solvent-cemented or elastomeric-gasketed joints in cold water building supply and yard piping. (See Section 604.1 and 609.1.2 for allowable location and pressure.) Installation, material, and inspection shall comply with the current edition of the Uniform Plumbing Code published by the International Association of Plumbing and Mechanical Officials, and shall also comply with this standard.

*Note: The following sections of the Uniform Plumbing Code apply to PVC water piping.*

202.0	Definition of PVC
Table 14-1	Materials
310.0	Workmanship
313.0	Protection of Piping, Materials, and Structures
314.0	Supporting in the Ground
315.0	Backfilling
316.1.5	Solvent-Cement Plastic Pipe Joints
606.2.2	Use of Joints
316.2.3	Plastic Pipe to Other Materials
Chapter 6	Water Distribution
604.1	Location
609.0	Depth of Piping

**Chapter 2 Definitions**

Chapter 14

ASTM	American Society for Testing and Materials
IAPMO	International Association of Plumbing and Mechanical Officials
NSF	National Sanitation Foundation
UPC	Uniform Plumbing Code published by IAPMO

**301.1 Minimum Standards**

**301.1.1 Material.** Materials shall conform to the appropriate standard in Table 14-1 of the Uniform Plumbing Code. See note ahead of Chapter 2 of this standard.

**Applicable Standards**

Type of PVC for Pipe and Fittings	ASTM Standard
PVC 1120 or 1220	D1784-81
Pipe	
Bell-End Poly(vinyl chloride)	
PVC Pipe	D2672-94
PVC Schedule 40	D1785-93
PVC Schedule 80	D1785-93
PVC 160 psi (1102.4 kPa) (SDR 26)	
PVC 200 psi (1378 kPa) (SDR 21)	
PVC 250 psi (1722.5 kPa) (SDR 17)	
PVC 315 psi (2170.4 kPa) (SDR 13.5)	D2241-93
Fittings	
Schedule 40 (Socket)	D2466-94
Schedule 80 (Socket)	D2467-94
Schedule 80 (Threaded)	D2464-94
Solvent Cement	
PVC Solvent Cement	D2564-93
Primers	
PVC Primers	F656-93

- 301.1.1.1 Pipe and Fittings.** Pipe and fittings are manufactured from PVC plastic.
- 301.1.2 Markings**
- 301.1.2.1 Pipe.** Pipe shall be marked at intervals of not more than five (5) feet (1524 mm) with at least the following:
- (a) Manufacturer's name or trademark;
  - (b) ASTM D1785 or D2241;
  - (c) In addition, bell end pipe, PVC, shall be marked D2672;
  - (d) Pipe size;
  - (e) PVC 1120 or PVC 1220;
  - (f) Schedule 40 or Schedule 80, SDR or pressure rating on SDR pipe;
  - (g) NSF seal or marking of other acceptable agency; and
  - (h) Pipe listed by IAPMO that is



covered by this standard shall be labeled with the designated IAPMO certification mark to show compliance with this standard.

**301.1.2.2**

**Fittings.** Fittings shall be marked with at least the following:

- (a) Manufacturer's name or trademark;
- (b) Size\*;
- (c) ASTM D2464, D2466, or D2467;
- (d) PVC 1 or PVC 12;
- (e) Schedule 40 or Schedule 80;
- (f) NSF seal or marking of other acceptable agency; and
- (g) Fittings listed by IAPMO that are covered by this standard shall be labeled with the designated IAPMO certification mark to show compliance with this standard.

*\*Note: Size and material designation may be omitted on smaller fittings.*

**301.1.2.3****Solvent Cement****301.1.2.3.1**

**Markings.** Solvent cement containers shall be marked with at least the following:

- (a) ASTM D2564;
- (b) NSF seal or marking of other acceptable agency; and
- (c) Solvent cement listed by IAPMO that is covered by this standard shall be labeled with the designated IAPMO certification mark to show compliance with this standard.

**301.1.2.3.2**

**Color.** Solvent cement shall not be purple in color.

**301.1.2.4****Primers****301.1.2.4.1**

**Markings.** Primer containers shall be marked with at least the following:

- (a) ASTM F656;
- (b) NSF seal or marking of other acceptable agency; and
- (c) Primer listed by IAPMO that is covered by this standard shall be labeled with the designated IAPMO certification mark to show compliance with this standard.

**301.1.2.4.2**

**Color.** Primer shall be purple.

**301.1.3**

**Position of Markings.** The identifying markings on pipe and

fittings shall be visible for inspection without moving materials.

**313.0****Protection of Piping****313.1**

**Storage.** Unprotected pipe should not be stored in direct sunlight. The pipe shall be stored in a way to protect it from mechanical damage (slitting, puncturing, etc.). Exposure to sunlight during normal construction periods is not harmful. PVC solvent cements should be stored in a cool place except when actually in use at the job site. The solvent cement manufacturer's specific storage recommendations should be followed.

**313.2**

**Alignment.** Pipe and fittings shall be aligned properly without strain.

**313.3**

**Thermal Expansion.** Pipe (except pipe with elastomeric gasketed joints) shall be snaked in the trench bottom with enough slack, at least 6 inches (152.4 mm) per 100 feet (30,480 mm), to compensate for thermal expansion and contraction before stabilizing piping. Stabilize piping by bringing it approximately to operating temperature before testing and backfilling by one of the following methods:

- (a) Shade backfill. Leave all joints exposed so that they can be examined during pressure test.
- (b) Fill with water at operating temperature.
- (c) Allow to stand overnight.

**313.4**

**Exposed Piping.** Vertical piping may extend a maximum of 24 in. (610 mm) above grade when located on the exterior of the building or structure and protected from mechanical damage to the satisfaction of the Authority Having Jurisdiction. Where exposed to sunlight, the pipe shall be wrapped with at least 0.040 in. (1.0 mm) of tape.

**315.0****Trenching, Cover, and Backfill****315.1**

**Trenching and Cover.** Trench bottoms shall be uniformly graded and shall be of either undisturbed soil or shall consist of a layer or layers of compacted backfill so that minimum settlement will take place.

**315.2 Backfill.** Selected backfill shall be used. Tamp the backfill that is placed around the pipe so as to provide firm continuous support and proper compaction. Backfill at least 12 inches (305 mm) over pipes, except that joints shall be left exposed. After inspection and pressure test, complete backfill.

**315.2.1 Elastomeric Joints.** Backfill immediately after installing pipe.

*Note: This is to maintain equal spaces within the joints for contraction and expansion.*

**316.1 Joints**

**316.1.1 Solvent Cement Joints**

**316.1.1.1 Selection.** Follow manufacturer's recommendations for types of solvent cement for such conditions as temperature over 100°F (38°C), humidity over 60 percent, or use of Schedule 80 fittings.

**316.1.1.2 Handling (to maintain effectiveness).**

Package solvent cement in containers no larger than 1 quart (1 liter). Keep solvent cement can closed and in the shade when not in use. Keep applicator submerged in solvent cement between applications. When solvent cement becomes thicker, THROW IT AWAY. Solvent cement shall NOT be thinned.

**316.1.1.3 Size of Applicator.** Applicator should be about one-half the pipe diameter. Do not use small applicators on large pipes.

**316.1.1.4 Primers.** All solvent cement PVC joints shall be made using a listed primer in compliance with ASTM F 656-93 and as specified in Section 316.1.5 of the UPC.

**316.1.1.5 Application.** Solvent cement shall be applied deliberately but without delay (two men may be needed to make large joints). Use special care when temperature is over 100°F (38°C) or humidity is over 60 percent.

**316.1.1.6 Procedure**

*Note: Do not take SHORTCUTS. Most failures are caused by shortcuts. DON'T*

TAKE A CHANCE.

**XI. Safety Requirements and Precautions<sup>1</sup>**

**X1.1 General.** Solvents contained in PVC plastic pipe cements are classified as airborne contaminants and flammable and combustible liquids. Precautions listed in this appendix should be followed to avoid injury to personnel and the hazard of fire.

**X1.2 Safety Precautions:**

**X1.2.1** Prolonged breathing of solvent vapors should be avoided.

When pipe and fittings are being joined in partially enclosed areas, a ventilating device should be used in such a manner to minimize the entry of vapors into the breathing areas.

**X1.2.2** Solvent cements should be kept away from all sources of ignition, heat, sparks, and open flame.

**X1.2.3** Containers for solvent cements should be kept tightly closed except when the cement is being used.

**X1.2.4** All rags and other materials used for mopping up spills should be kept in a safety waste receptacle which should be emptied daily.

**X1.2.5** Most of the solvents used in PVC pipe cements can be considered eye irritants, and contact with the eye should be avoided for it may cause eye injury. Proper eye protection and the use of chemical goggles or face shields is advisable where the possibility of splashing exists in handling solvent cements. In case of eye contact, flush with plenty of water for 15 minutes and call a physician immediately.

**X1.2.6** Repeated contact with the skin should be avoided. Proper gloves impervious to and unaffected by the solvents should be worn when frequent

contact with the skin is likely. Application of the solvents or solvent cement with rags and bare hands is not recommended. Brushes and other suitable applicators can be used effectively for applying the solvent cement, thus avoiding skin contact. In the event of excessive contact, remove contaminated clothing and wash skin with soap and water.

**CAUTION:** *Primers are toxic. Don't allow them to touch skin. Suitable gloves are advised.*

- Step 1 Cut pipe square with hand saw and miter box, mechanical cut-off saw, or tube cutter designed for plastic.
- Step 2 Ream and chamfer pipe to eliminate sharp edges, beads and all burrs.
- Step 3 Clean all dirt, moisture, and grease from pipe and fitting socket. Use a clean, dry rag.
- Step 4 Check dry fit of pipe in fitting. Pipe should enter fitting socket from 1/3 to 3/4 depth of socket.
- Step 5 Soften inside socket surface by applying an aggressive primer.
- Step 6 Soften mating outside surface of pipe to depth of socket by applying a liberal coat of the (aggressive) primer. Be sure entire surface is softened.
- Step 7 Again coat inside socket surface with the (aggressive) primer. Then, without delay, apply solvent cement liberally to outside of pipe. Use more than enough to fill any gaps.
- Step 8 Apply a light coat of PVC solvent cement to inside of socket using straight outward strokes (to keep excess solvent out of socket). This is also to prevent solvent cement damage to pipe. For loose fits, apply a second coat of solvent cement. Time is important at this stage. See Section 316.1.1.4.
- Step 9 While both the inside socket surface and the outside surface of the pipe are SOFT and WET with solvent cement, forcefully bottom the pipe in the socket, giving the pipe a one-quarter turn, if possible. The pipe must go to the bottom of the socket.
- Step 10 Hold the joint together until tight.
- Step 11 Wipe excess cement from the pipe. A properly made joint will normally show a bead around its entire

**MINIMUM CURE TIME, IN HOURS\*  
TEST PRESSURE FOR PIPE**

	Sizes 1/2" to 1-1/4" (12.7 mm) (32 mm)		Sizes 1-1/2" to 3" (38 mm) (76 mm)		Sizes 3-1/2" to 8" (89 mm) (203 mm)	
	Up to 180 psi (1240.2 kPa)	Above 180 to 370 psi (1240.2 to 2549.3 kPa)	Up to 180 psi (1240.2 kPa)	Above 180 to 315 psi (1240.2 to 2170.4 kPa)	Up to 180 psi (1240.2 kPa)	Above 180 to 315 psi (1240.2 to 2170.4 kPa)
Temperature Range During Cure Period						
60°F-100°F (16°C-38°C)	1 hr	6 hr	2 hr	12 hr	6 hr	24 hr
40°F-60°F (4°C-16°C)	2 hr	12 hr	4 hr	24 hr	12 hr	48 hr
10°F-40°F (-12°C+4°C)	8 hr	48 hr	16 hr	96 hr	48 hr	8 days

\*If gaps or loose fits are encountered in the system, double these cure times.

perimeter. Any gaps may indicate insufficient cement or the use of light bodied cement on larger diameters where heavy bodied cement should have been used.

- Step 12 Do not disturb joint for the following periods:  
 30 minutes minimum at 60°F to 100°F (16°C to 38°C)  
 1 hour minimum at 40°F to 60°F (4°C to 16°C)  
 2 hours minimum at 20°F to 40°F (-7°C to 4°C)  
 4 hours minimum at 0°F to 20°F (-18°C to -7°C)  
 Handle the newly assembled joints carefully during these periods. If gaps (step 11) or loose fits are encountered in the system, double these periods.

- Step 13 The system shall not be pressurized until the joints have cured (set) at least as long as recommended by the manufacturer. If manufacturer's recommendation is not available the following cure times are required:

**316.1.2 Threaded Joints.** Joints shall be tightened approximately 1/2 turn past handtight, using a strapwrench.

**CAUTION:** Handtight refers to number of threads to reach handtight with metal pipe. Pipe can be bottomed in small sizes of PVC by hand pressure alone. Do not overtighten.

**705.1 Elastomeric Gasketed Joints, Procedure:**

- Step 1 For field cuts, cut end of pipe square with handsaw and miter box, mechanical saw, or a tube cutter designed for plastic.
- Step 2 Ream and bevel end of pipe unless already done by manufacturer.
- Step 3 If dirty, remove gasket, clean gasket and groove, and replace ring.
- Step 4 Mark pipe in a contrasting color to indicate the proper insertion depth as recommended by the manufacturer (unless already done by manufacturer).

- Step 5 Apply lubricant recommended by pipe manufacturer to end of pipe. Do not apply lubricant to gasket or the groove unless specifically recommended by the manufacturer.

- Step 6 Insert pipe into fitting until mark on pipe is even with fitting.  
*Note: This depth of insertion is required to properly allow for thermal expansion and contraction. During joint assembly, the previously installed length of pipe should be held so that the existing joints are not pushed together or pulled apart. DO NOT USE METAL STRAPS, CHAINS, OR THE LIKE FOR ASSEMBLY.*

**604.0**

**Material**

**604.1**

**Location.** PVC piping shall be installed only outside the foundation of any building, or structure, or parts thereof. It shall be buried in the ground for its entire length, except that vertical piping may be extended above grade per Section 313.4. It shall not be installed within or under any building or structure, mobile home, commercial coach, or parts thereof. The term building or structure or parts thereof shall include structures such as porches and steps, whether roofed or not, roofed porte cocheres, roofed patios, carports, covered walks, covered driveways, and similar structures or appurtenances.

**609.0**

**Installation, Testing, and Identification**

**609.1**

**Installation**

**609.1.1**

**Deflection.** Elastomeric gasketed pipe may be deflected in accordance with the manufacturer's recommendations provided that it not be permanently staked or blocked to maintain this deflection.

**609.1.2**

**Maximum Working Pressure.**

Maximum working pressure shall be as follows (see chart on following page).

**609.1.3**

**Saddles.** PVC pressure pipe saddles are limited to underground use outside the building. The branch of the saddle shall be a minimum of two pipe sizes smaller than the main. Saddles shall be installed as required by their listings.

**609.1.4**

**Thrust Blocking.** In lines with rubber

gasketed joints, thrust blocks shall be installed at all:

- (a) Changes in direction, as at tees and bends;
- (b) Changes in size, as at reducers;
- (c) Stops, as at dead ends; and
- (d) Valves, where thrusts may be expected; and thrust block sizes shall be based on the maximum line pressure, pipe size, and kind of soil. Refer to Table 609.1.4(a) for thrust at fittings for a pressure of 100 psi (689 kPa).

**TABLE 609.1.4(a)**

**Thrust at Fittings in Pounds at 100 psi**

Pipe Size	90°	45°	22-1/2°	Dead Ends
Inches	Bends	Bends	Bends	and Tees
1-1/2	415	225	115	295
2	645	350	180	455
2-1/2	935	510	260	660
3	1395	755	385	985
3-1/2	1780	962	495	1260
4	2295	1245	635	1620
5	3500	1900	975	2490
6	4950	2710	1385	3550
8	8300	4500	2290	5860
10	12,800	6900	3540	9050
12	18,100	9800	5000	12,800

**Thrust at Fittings in Pascals at 689 kPa of Water Pressure**

Pipe Size	90°	45°	22-1/2°	Dead Ends
mm	Bends	Bends	Bends	and Tees
38	1846.8	1001.3	511.8	1312.8
51	2870.3	1557.5	801.0	2024.8
64	4160.8	2269.5	1157.0	3937.0
76	6207.8	3359.8	1713.3	4383.3
89	7921.0	4280.9	2202.8	5607.0
102	10,212.8	5540.3	2815.8	7209.0
127	15,575.0	8455.0	4338.8	11,080.5
152	22,027.5	12,059.5	6163.3	15,797.5
203	36,935.0	20,025.0	10,190.5	26,077.0
254	56,960.0	30,705.0	15,753.0	40,272.5
305	80,545.0	43,610.0	22,250.0	56,960.0

Example for Table 609.1.4(a):

For a pressure of 150 psi (1033.5 kPa) on a 4 inch (102mm) tee, Table 609.1.4(a) indicates 1620 pounds (7209 N) for 100 psi (689 kPa). Therefore,

total thrust for 150 psi (1033.5 kPa) will equal 1-1/2 times 1620 pounds (7209 N) for a total thrust of 2430 pounds (10,810 N).

To determine the bearing area of thrust blocks, refer to Table 609.1.4(b) for the safe bearing load of the soil and divide the total thrust by this safe bearing load.

**TABLE 609.1.4(b)**  
**Safe Bearing Loads of Various Soils**

Soil	Safe Bearing Lbs./sq. ft	Load kPa
Mulch, Peat, etc.	0	0
Soft Clay	1000	6890
Sand	2000	13,780
Sand and Gravel	3000	20,670
Sand and Gravel Cemented with Clay	4000	27,360
Hard Shale	10,000	68,900

*Example:* Assume a 4000 pound (17,800 N) total thrust was computed. The soil condition is sand. The required bearing area of the thrust block is 4000 lbs. (17,800 N) divided by 2000 lbs. (13,780 kPa) or 2 square feet (0.19 m<sup>2</sup>).

**609.2 Testing**

**609.2.1 Rubber Gasketed Joints.** Properly sized thrust blocks, either permanent or temporary, shall be installed at all required points before testing. See Section 609.1.4. When concrete thrust blocks are installed, wait at least 24 hours before pressure testing.

**609.2.2 Solvent Cement Joints.** The entire system shall be purged before testing to eliminate all solvent cement vapors and air.

*CAUTION: Water test only.*

**609.3 Identification.** A label shall be fastened to the main electrical meter panel stating, "This structure has a nonmetallic water service."

**610.0 Sizing**

**610.1** Piping shall be sized in accordance with UPC Section 610.0. When UPC Appendix A is applicable, use UPC Chart A-5 (Fairly smooth). Flow velocity shall not exceed 8 fps (2.4 m/s).

This standard is a combination of sections from the previous standards IS 8 and IS 14. IS 8 was originally

adopted in 1968 and revised in 1971, 1972, 1973, and 1975. IS 14 was originally adopted in 1972 and revised in 1975. Upon adoption of this rewrite, IS 14 was deleted.

**Rewrite ratified by membership: 1978**

**Revised: 1980, 1981, 1984, 1986, 1989, 1991, 1992, 1995**

<sup>1</sup> Appendix XI, Safety Requirements and Precautions from ASTM D2564-81a, Solvent Cements for Poly (Vinyl Chloride) (PVC) Plastic Pipe and Fittings, is reprinted with permission from the American Society for Testing and Materials, 1916 Race Street, Philadelphia, PA 19103, copyright.

Pipe	Fittings		Maximum Working Pressure
	Schedule	Sizes	
160 psi (SDR 26) (1102.4 kPa)	40	1/2" thru 8" incl. (12.7 mm – 203 mm)	160 psi - 1102.4 kPa
	80	1/2" thru 8" incl. (12.7 mm – 203 mm)	160 psi - 1102.4 kPa
200 psi (SDR 21) (1378 kPa)	40	1/2" thru 4" incl. (12.7 mm – 102 mm)	200 psi - 1378 kPa
	80	1/2" thru 8" incl. (12.7 mm – 203 mm)	200 psi - 1378 kPa
250 psi (SDR 17) (1722.5 kPa)	40	1/2" thru 3" incl. (12.7 mm – 76 mm)	250 psi - 1722.5 kPa
	80	1/2" thru 8" incl. (12.7 mm – 203 mm)	250 psi - 1722.5 kPa
315 psi (SDR 13.5) (2170.4 kPa)	40	1/2" thru 1-1/2" incl. (12.7 mm – 38 mm)	315 psi - 2170.4 kPa
	80	1/2" thru 4" incl. (12.7 mm – 102 mm)	315 psi - 2170.4 kPa
Schedule 40	40	1/2" thru 1-1/2" incl.	320 psi - 2204.8 kPa
	80	(12.7 mm - 38 mm)	
	40	2" thru 4" incl.	220 psi - 1515.8 kPa
	80	(51 mm – 102 mm)	
40	5" thru 8" incl. (127 mm – 203 mm)	160 psi - 1102.4 kPa	
Schedule 80	40	1/2" thru 1-1/2" incl. (12.7 mm – 38 mm)	320 psi - 2204.8 kPa
	40	2" thru 4" incl. (51mm – 102 mm)	220 psi - 1515.8 kPa
	40	5" thru 8" incl. (127 mm – 203 mm)	160 psi - 1102.4 kPa
	80	1/2" thru 4" incl. (12.7 mm – 102 mm)	320 psi - 2204.8 kPa
	80	5" thru 8" incl. (127 mm – 203 mm)	250 psi - 1722.5 kPa

**LOCATION OF THRUST BLOCKS**  
(Standard and metric combined)  
A Comparison of Thrust-Block Areas

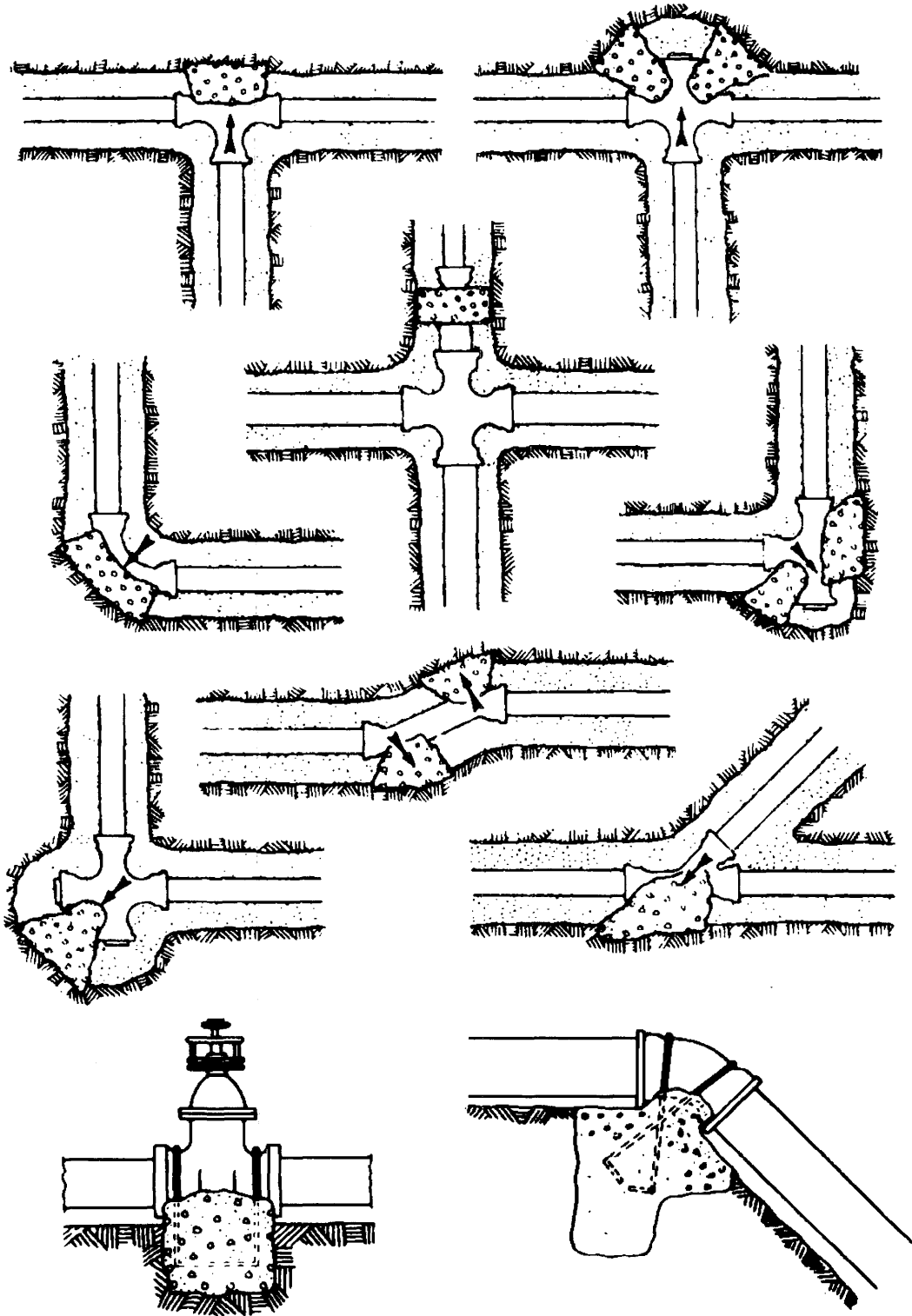

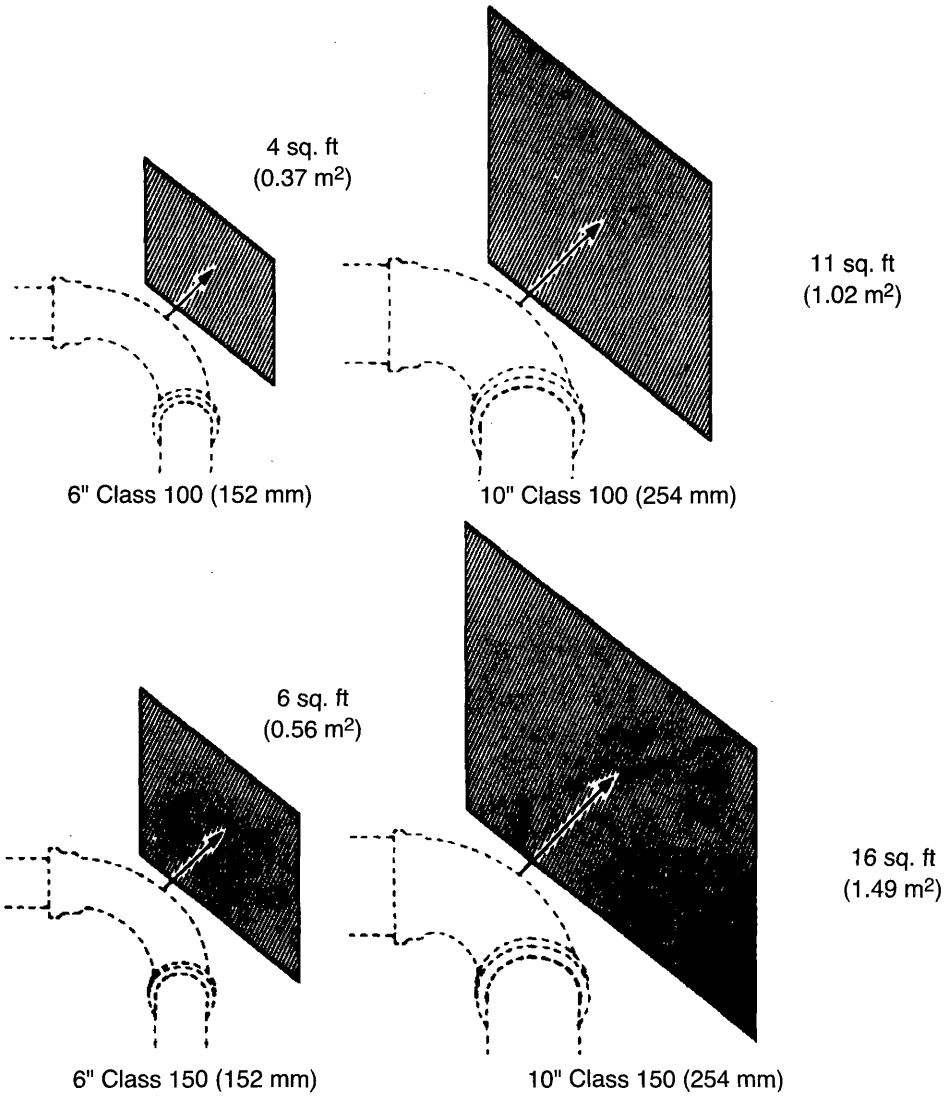
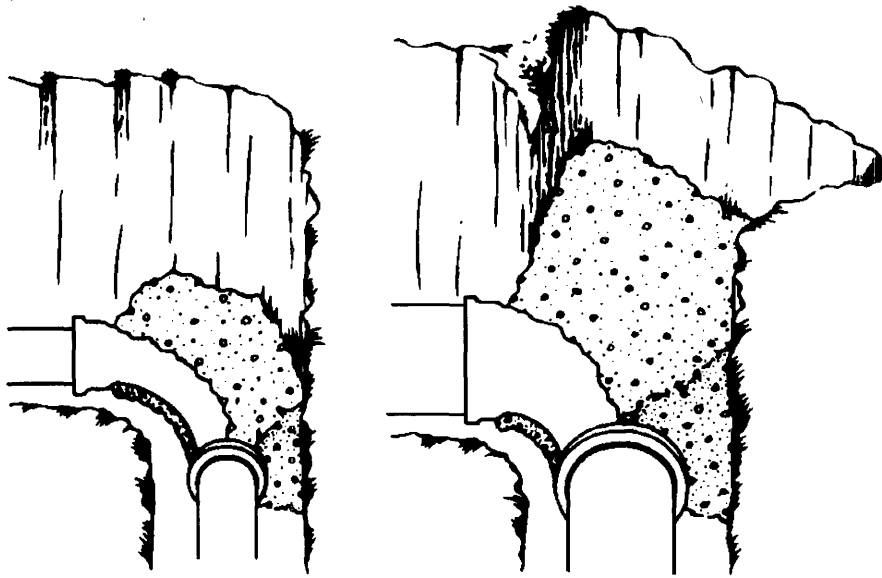





**Installation Standard  
For  
PVC BUILDING DRAIN, WASTE AND VENT PIPE AND FITTINGS**

**IAPMO IS 9-95**

This installation standard shall apply to PVC building drain, waste, and vent systems as governed by the Uniform Plumbing Code. Material Standard ASTM D2665-85a, Standard Specification for Poly (Vinyl Chloride) (PVC) Plastic Drain, Waste and Vent Pipe and Fittings, shall form part of this installation standard.

Installation, material, and inspection shall comply with the current edition of the Uniform Plumbing Code published by the International Association of Plumbing and Mechanical Officials and shall also comply with this standard.

*Note: The Building Official shall be consulted about penetration of fire separations, height and area, or other limitations.*

*Note: The following sections of the Uniform Plumbing Code apply.*

202.0 Table 14-1	Definition of PVC Pipe and Fittings ASTM D2665-94 D2122-90 ASTM D3311-92 <sup>1</sup>
301.1	Minimum Standards
704.4.1 and 704.4.3	Closet Flanges
707.1	Cleanout Fittings
311.8	Screwed Fittings
310.0	Workmanship
311.0	Prohibited Fittings and Practices
101.4.1.1	Repairs and Alterations
313.0	Protection of Piping, Materials, and Structures
314.0	Hangers and Supports (Vertical Piping)
314.0	Hangers and Supports (Horizontal Piping)
103.5	Inspections
103.5.3	Testing
701.0	Materials (Drainage)
903.1 and 903.3	Materials (Venting)

903.4	Straining or Bending Pipe
1003.0	Traps Described
316.1.1	Threaded Joints
316.1.5	Type of Joints – Solvent Cement Plastic Pipe Joints
316.2.3	Special Joints
316.3.1	Flanged Fixture Connections
316.4	Prohibited Joints and Connections
317.0	Increases and Reducers
1101.3	Materials Uses

**ABBREVIATIONS**

ASTM	American Society for Testing and Materials
IAPMO	International Association of Plumbing and Mechanical Officials
UPC	Uniform Plumbing Code

**301.1 Minimum Standards**

**301.1.1 Pipe**

PVC pipe is furnished in straight lengths. The pipe is usually dark gray, ivory, or white in color with identification markings as shown below. The pipe wall is the same thickness as that of Schedule 40 (IPS) standard steel pipe.

Pipe shall be marked on two sides 180° apart or spirally in letters not less than 3/16 inch (4.8 mm) high in a contrasting color and shall contain at least the following at intervals of not more than 2 feet (610 mm):

- (a) Manufacturer's name or trademark;
- (b) Nominal pipe size;
- (c) Symbol PVC-DWV<sup>2</sup>;
- (d) Products listed by IAPMO that are covered by this standard should be

<sup>1</sup> Although referenced in this standard, some of the fittings shown in the standard are not acceptable under the Uniform Plumbing Code.

<sup>2</sup> It is common practice to dual mark Schedule 40 DWV and potable water piping in which compliance with each applicable standard is met.

labeled with the designated IAPMO certification mark; and

- (e) Any other markings required or permitted by law.

### 301.1.2 Fittings

Fittings are usually furnished in dark gray, ivory, or white with indelible markings as shown below. Refer to tables in ASTM D2665-94 and D3311-92 for dimensions and tolerances for pipe, fittings, sockets, and laying lengths.

Fittings shall be marked on the body or hub on both sides. The markings shall consist of at least the following:

- (a) Manufacturer's name or trademark;
- (b) Symbol PVC-DWV;
- (c) Products listed by IAPMO that are covered by this standard shall be labeled with the designated IAPMO certification mark; and
- (d) Any other markings required or permitted by law.

### 301.1.3 Solvent Cement

Solvent cement shall be as specified in ASTM Standard D2564-80. Solvent cement labels shall contain at least the following:

- (a) Manufacturer's or supplier's name and address, trade name, trademark, or both;
- (b) Cement for PVC (pipe and fittings);
- (c) ASTM designation D2564;
- (d) Lot number;
- (e) Recommended procedure for use and safety precautions;
- (f) Cement type according to viscosity and pipe size;
- (g) End use application;
- (h) Products listed by IAPMO that are covered by this standard shall be labeled with the designated IAPMO certification mark; and
- (i) Any other markings required or permitted by law.

### 301.1.3.1 Solvent cements shall not be purple in color.

### 301.1.4 Primers

Primer shall be as specified in ASTM F656-93.

Primer containers shall be marked with at least the following:

- (a) Manufacturers, or suppliers, name and address, trademark, or trade name;
- (b) ASTM F656;
- (c) Function of primer;
- (d) Procedure or instructions for application and use;
- (e) Lot number;
- (f) Primer intended for use with potable water shall show compliance with NSF; and
- (g) Products listed by IAPMO that are covered by this standard shall be labeled with the designated IAPMO certification mark.

### 301.1.4.1 Primer shall be purple.

## 310.0 Workmanship

### 310.1 Alignment

All piping system components shall be aligned properly without strain. Pipe shall not be bent or pulled into position. Vertical piping shall be maintained in straight alignment between floors with midstory guides. Pipe and fittings shall be so positioned that identifying markings shall be readily visible for inspection.

## 313.0 Protection of Piping

### 313.1 Storage

Pipe and fittings should not be stored in direct sunlight; however, exposure to sunlight during normal construction periods is not considered harmful. Pipe shall be stored in such a manner as to prevent sagging or bending.

### 313.2 Expansion and Contraction

Thermal expansion and contraction of plastic drain waste and vent systems shall be taken into consideration. Thermal expansion and contraction may be controlled by several methods: offset, expansion joints, or restraints. Regardless of method utilized, certain conditions shall be met.

- (a) Support but do not rigidly restrain piping at changes of direction.
- (b) Do not anchor pipe rigidly in walls.



**313.4 Protection from Damage**

Piping passing through wood studs or plates shall be protected from puncture by a minimum 1/16 inch (1.6 mm) thick steel plate. Piping shall be protected from concrete form oil.

**313.5 Anti-Freeze Protection**

PVC pipe and traps can be protected from freezing by the use of one of the following solutions of mixtures:

- (a) 4 quarts (3.8 liters) of water mixed with 5 quarts (4.8 liters) of glycerol,
- (b) 2-1/2 lbs. (1.1 kg) of magnesium chloride dissolved in one (1) gallon (3.8 liters) of water, or
- (c) 3 lbs. (1.4 kg) of table salt dissolved in one (1) gallon (3.8 liters) of water.

The salt solutions are effective to approximately 10°F (-12°C). If lower temperatures are anticipated, the pipe should be drained, or the glycerol solution should be used.

**313.6 Piping Installed in Fire-Resistive Construction**

Where piping is installed and penetrates required fire-resistive construction, the fire-resistive integrity of the construction shall be as required by the Administrative Authority or, when not established by the building code, by qualified testing methods approved by the Administrative Authority. Approval shall be obtained prior to installing any such piping.

**314.0 Hangers and Supports****314.1 Abrasion**

Hangers and straps shall not compress, distort, cut, or abrade the piping and shall allow free movement of pipe. Pipe exposed to damage by sharp surfaces shall be protected.

**314.2 Support**

Support all horizontal piping at intervals of not more than four (4) feet (1219 mm), at end of branches, and at change of direction or elevation. Supports shall allow free movement but shall restrict upward movement of lateral runs so as not to create reverse grade. Vertical piping shall be supported at each story or floor level.

Alignment of vertical piping shall be maintained between floors with the use of a midstory guide. Support trap arms in excess of three (3) feet (915 mm) in length as close as possible to the trap. Closet flanges shall be securely fastened with corrosion resistant fasteners to the floor with top surface one-quarter (1/4) inch (6.4 mm) above finish floor.

**1003.0****Traps****1003.1****Connection to Metal Traps**

Traps shall be connected by means of listed threaded trap adapters.

**705.1****Joints****705.1.1****Caulked Joints**

Make connections or transitions to bell-and-spigot cast-iron soil pipe fittings, and to bell-and-spigot pipe and fittings of other materials with listed mechanical compression joints designed for this use, or caulked joints made in an approved manner. In caulking, pack the joint with oakum or hemp and fill with molten lead to a depth of not less than one (1) inch (25.4 mm). Allow a period of four (4) minutes for cooling. After cooling, caulk the lead at the inside and outside edges of the joint. Lead shall not be overheated.

**316.1****Solvent Cement Joints**

(Additional information is available in ASTM D2855.)

**316.1.1**

**Selection.** Follow manufacturer's recommendations for type of solvent cement for such conditions as temperature over 100°F (38°C) or humidity over 60 percent.

**316.1.2****Handling (to maintain effectiveness).**

Solvent cement and primer containers no larger than 1 quart (1 liter) should be used in the field (to avoid thickening due to evaporation). Keep containers closed and in the shade when not in use. Keep applicators submerged in solvent cement between applications. When solvent cement becomes thicker, THROW IT AWAY. Solvent cement shall NOT be thinned.

**316.1.3**

**Size of Applicator.** Applicator should

be about one-half the pipe diameter. Do not use small applicators on large pipes. Ordinary pure bristle paintbrushes or applicators furnished with product are satisfactory.

**316.1.4 Primers.** A listed primer in compliance with ASTM F 656-93 shall be used on all PVC DWV joints.

**316.1.5 Application.** Solvent cement and primer shall be applied deliberately but without delay (two men may be needed to make large joints). Use special care when temperature is over 100°F (38°C) or humidity is over 60 percent.

#### **316.1.6 Procedure.**

##### **XI. Safety Requirements and Fire Cautions**

**XI.1 General.** Solvents contained in PVC plastic pipe cements are classified as airborne contaminants and flammable and combustible liquids. Precautions listed in this appendix should be followed to avoid injury to personnel and the hazard of fire.

##### **XI.2 Safety Precautions:**

**XI.2.1** Prolonged breathing of solvent vapors should be avoided. When pipe and fittings are being joined in partially enclosed areas, a ventilating device should be used in such a manner as to minimize the entry of vapors into the breathing areas.

**XI.2.2** Solvent cements should be kept away from all sources of ignition, heat, sparks, and open flame.

**XI.2.3** Containers for solvent cements should be kept tightly closed except when the cement is being used.

**XI.2.4** All rags and other materials used for mopping up spills should be kept in a safety waste receptacle, which should be emptied daily.

**XI.2.5** Most of the solvents used in PVC pipe cements can be considered eye irritants, and contact with the eye should be avoided for it may cause eye

injury. Proper eye protection and the use of chemical goggles or face shields is advisable where the possibility of splashing exists in handling solvent cements. In case of eye contact, flush with plenty of water for 15 minutes and call a physician immediately.

**XI.2.6** Repeated contact with the skin should be avoided. Proper gloves impervious to and unaffected by the solvents should be worn when frequent contact with the skin is likely. Application of the solvents or solvent cements with rags and bare hand is not recommended. Brushes and other suitable applicators can be used effectively for applying the solvent cement, thus avoiding skin contact. In the event of excessive contact, remove contaminated clothing and wash skin with soap and water.

**Step 1** Cut pipe square with hand saw and miter box, mechanical cut-off saw, or tube cutter designed for plastic.

**Step 2** Ream inside and chamfer outside of pipe to eliminate all burrs.

**Step 3** Clean all dirt, moisture, and grease from pipe and socket. Use a clean, dry rag.

**Step 4** Check dry fit of pipe in fitting. Pipe should enter fitting socket from 1/3 to 3/4 depth of socket.

**Step 5** Soften inside socket surface by applying an aggressive primer.

**Step 6** Soften mating outside surface of pipe to depth of socket by applying a liberal coat of the (aggressive) primer. Be sure the entire surface is softened.

**Step 7** Again coat inside socket surface with the (aggressive) primer. Then, without delay, apply solvent cement liberally to outside of pipe. Use more than enough to fill any gaps.

**Step 8** Apply a light coat of PVC solvent cement to inside of socket using

straight outward strokes (to keep excess solvent out of socket). This is also to prevent solvent cement

damage to pipe. For loose fits, apply a second coat of solvent cement. Time is important at this stage. See Section 316.1.4.

Step 9 While both the inside socket surface and the outside surface of the pipe are SOFT and WET with solvent cement, forcefully bottom the pipe in the socket, giving the pipe a one-quarter turn, if possible. The pipe must go to the bottom of the socket.

Step 10 Hold the joint together until tight partial set.

Step 11 Wipe excess cement from the pipe. A properly made joint will normally show a bead around its entire perimeter. Any gaps may indicate insufficient cement or the use of light-bodied cement on larger diameters where heavy-bodied cement should have been used.

Step 12 The system shall not be tested until the joints have cured (set) at least as long as recommended by the manufacturer.

### 316.1.7 Threaded Joints

Listed adapter fittings shall be used for the transition to threaded connections. No threaded PVC female fitting(s) or joint(s) shall be located in a non-accessible location. The joint between the PVC pipe and adapter fittings shall be of the solvent cement type.

Only listed thread tape or thread lubricant specifically intended for use with plastics shall be used. Conventional pipe thread compounds, putty, linseed oil base products, and unknown mixtures shall not be used. Pipe and fittings which have come in contact with the above non-approved mixtures shall be removed and replaced with new materials.

Where a threaded joint is made, obtain tightness by maximum hand tightening plus additional tightening with a strap wrench not to exceed one full turn.

### 316.2 Special Joints

#### 316.2.1 Connection to Non-Plastic Pipe

When connecting plastic pipe to other types of piping, use listed fittings and adapters designed for the specific use intended.

#### 316.4 Prohibited Fittings and Connections

(a) **Drainage system** – Any fitting or connection which has an enlargement, chamber, or recess with a ledge, shoulder, or reduction of pipe area that offers an obstruction to flow through the drain is prohibited.

(b) No fitting or connection that offers abnormal obstruction to flow shall be used. The enlargement of a three (3) inch (76 mm) closet bend or stub to four (4) inches (102 mm) shall not be considered an obstruction.

**ADOPTED: 1968**

**REVISED: 1971, 1974, 1975, 1976, 1977, 1981, 1982, 1983, 1987, 1989, 1990, 1991, 1992, 1995**

**Installation Standard  
For  
ABS SEWER PIPE AND FITTINGS**

**IAPMO IS 11-87**

This Installation Standard shall apply to ABS Building Sewer Pipe and Fittings as governed by the Uniform Plumbing Code. Material Standard ASTM D2751-83a, *Standard Specification for ABS Sewer Pipe and Fittings*, shall form part of this Installation Standard. Materials shall be limited to building sewers receiving domestic sewage, excluding special and industrial waste.

*Note: The following sections of the Uniform Plumbing Code apply.*

202.0	Definition of ABS
202.0	Domestic Sewage
Table 14-1	ASTM D27511
301.1	Minimum Standards
310.0	Workmanship
312.0	Independent Systems
101.4.1.1.2	Repairs and Alterations
313.3 and 313.4	Protection of Piping, Materials, and Structures
314.0	Hangers and Supports
315.0	Trenching, Excavation, and Backfill
103.5	Inspection and Testing
723.0	Building Sewer Test
705.1.1	Caulked Joints
316.1.5	Types of Joint
705.1.7	Elastomeric Gasketed and Rubber-Ring Joints
317.0	Increases/Reducers
713.0	Sewer Required
715.0	Building Sewer Materials
718.0	Grade, Support, and Protection of Building Sewers
719.0	Cleanouts
720.0	Sewer and Water Pipes

<sup>1</sup> Although this standard is referenced in Table 14-1, some of the tubes or fittings shown in the standard are not acceptable for use under the Uniform Plumbing Code.

**301.1**

**301.1.1**

**Minimum Standards**

**Pipe**

ABS pipe is furnished in straight lengths. Refer to tables in D2751-93a for dimensions and tolerances for pipe and pipe sockets.

Pipe shall be marked on two sides 180° apart or spirally in letters not less than 1/4 inch (6.4 mm) high in a contrasting color and shall contain at least the following at no more than 5 foot (1524 mm) intervals:

- (a) Manufacturer's name or trademark and code;
- (b) Nominal pipe size;
- (c) The legend "ABS Sewer Pipe";
- (d) ASTM Designation D2751;
- (e) Pipe SDR number;
- (f) Products listed by IAPMO that are covered by this standard shall be labeled with the designated IAPMO certification mark;
- (g) Any other marking required or permitted by law; and
- (h) Coextruded pipe shall be marked "coex".

**301.1.2**

**Fittings**

Refer to tables in ASTM D2751-93a for dimensions and tolerances for fitting sockets, spigots and laying lengths. Fittings shall be marked on the body or hub. The markings shall consist of at least the following:

- (a) Manufacturer's name or trademark;
- (b) Nominal size;
- (c) The material designation "ABS."
- (d) ASTM Designation D 2751;
- (e) Products listed by IAPMO that are covered by this standard shall be labeled with the designated IAPMO certification mark; and
- (f) Any other markings required or permitted by law.

**301.1.3**

**Solvent Cement**

Solvent cement shall be as specified in



ASTM Standard D2235-93a. Solvent cement labels shall contain at least the following:

- (a) Manufacturer's name or trademark;
- (b) Cement for ABS (pipe and fittings);
- (c) ASTM designation D 2235;
- (d) Recommended procedure for use and safety precautions;
- (e) Products listed by IAPMO that are covered by this standard shall be labeled with the designated IAPMO certification mark; and
- (f) Any other marking required or permitted by law.

### 310.0 Workmanship

#### 310.1 Alignment

All piping system components shall be aligned properly without strain. Pipe shall not be bent or pulled into position after being solvent cemented. Pipe and fittings shall be so positioned that identifying markings shall be readily visible for inspection.

### 313.0 Protection of Piping

#### 313.1 Storage

Pipe and fittings should not be stored for long periods in direct sunlight. However, exposure to direct sunlight during normal construction periods is not harmful. Pipe shall be stored in such a manner as to prevent sagging or bending.

### 315.0 Trenching, Excavation, and Backfill

#### 315.1 Trenching

The width of the trench at any point below the top of the pipe should not be greater than necessary to provide adequate room for joining the pipe and compacting the side fills.

#### 315.2 Alignment and Grade

The pipe should be bedded true to line and grade, uniformly and continuously supported on firm, stable material. Blocking shall not be used to bring the pipe to grade. The bedding shall conform to Section 718.0 of the Uniform Plumbing Code.

#### 315.3 Backfill

The backfill shall conform to Section

315.0 of the Uniform Plumbing Code.

## 705.0

### Joints

#### 705.1

#### Caulked Joints

Make connections or transitions to bell-and-spigot cast-iron soil pipe and fittings, and to bell-and-spigot pipe and fittings of other materials with approved mechanical compression joints designed for this use, or caulked joints made in an approved manner.

In caulking, pack the joint with oakum or hemp and fill with molten lead to a depth of not less than one (1) inch (25.4 mm). Allow a period of four (4) minutes for cooling. After cooling, caulk the lead at the inside and outside edges of the joint. Lead shall not be overheated.

*Note: Caulked joints should be avoided if possible.*

#### 705.2

#### Gasket-Type Joints

Pipe shall be cut square with saws or pipe cutters designed specifically for plastic pipe; protect pipe and fittings from serrated holding devices and abrasion.

1. Wipe the pipe spigot, rubber gasket, and inside of the socket clean of all dirt and moisture.
2. Coat the socket and gasket evenly with a vegetable-based paste lubricant.
3. Slide the gasket on the spigot and against the backup ring, and snap it to remove any twist.
4. Force the spigot into the socket. Check that the joint is properly connected by using any thin feeler gauge that the gasket is not looped back over the backup ring.

## 316.0

### Solvent Cement Joints

#### 316.1

**Selection.** Solvent cement shall be recommended for ABS by the manufacturer. Follow manufacturer's recommendations for types of solvent cement for such conditions as temperature over 100°F (38°C) or humidity over 60 percent.

#### 316.1.1

#### Handling (to maintain effectiveness).

Solvent cement containers no larger than 1 quart (1 liter) should be used in the field (to avoid thickening due to evaporation). Keep container closed

and in the shade when not in use. Keep applicator submerged in solvent cement between applications. When solvent cement becomes thicker, THROW IT AWAY. Solvent cement shall NOT be thinned.

**316.1.2 Size of Applicator.** Applicator should be about one-half the pipe diameter. Do not use small applicator on large pipes. Ordinary pure bristle paintbrushes or applicators furnished with product are satisfactory.

**316.1.3 Application.** Solvent cement shall be applied deliberately but without delay (two men may be needed to make large joints). Use special care when temperature is over 100°F (38°C) or humidity is over 60 percent.

**316.1.4 Procedure**

**X1** Safety Requirements and Precautions

**X1.1 General.** Solvents contained in ABS plastic pipe cements are classified as airborne contaminants and flammable and combustible liquids. Precautions listed in this appendix should be followed to avoid injury to personnel and the hazard of fire.

**X1.2 Safety Precautions:**

**X1.2.1** Prolonged breathing of solvent vapors should be avoided. When pipe and fittings are being joined in partially enclosed areas, a ventilating device should be used in such a manner to minimize the entry of vapors into the breathing areas.

**X1.2.2** Solvent cements should be kept away from all sources of ignition, heat, sparks, and open flame.

**X1.2.3** Containers for solvent cements should be kept tightly closed except when the cement is being used.

**X1.2.4** All rags and other materials used for mopping up spills should be kept in a safety waste receptacle which should be emptied daily.

**X1.2.5** Most of the solvents used in ABS pipe cements can be considered eye irritants, and contact with the eye should be avoided for it may cause eye injury. Proper eye protection and the use of chemical goggles or face shields is advisable where the possibility of splashing exists in handling solvent cements.

In case of eye contact, flush with plenty of water for 15 minutes and call a physician immediately.

**X1.2.6** Repeated contact with the skin should be avoided. Proper gloves impervious to and unaffected by the solvents should be worn when frequent contact with the skin is likely. Application of the solvents or solvent cements with rags and bare hands is not recommended. Brushes and other suitable applicators can be used effectively for applying the solvent cement, thus avoiding skin contact. In the event of excessive contact, remove contaminated clothing and wash skin with soap and water.

**Step 1** Cut pipe square with hand saw and miter box, mechanical cut-off saw, or tube cutter designed for plastic.

**Step 2** Ream inside and chamfer outside of pipe to eliminate all burrs.

**Step 3** Clean all dirt, moisture, and grease from pipe and socket. Use a clean, dry rag.

**Step 4** Check dry fit of pipe in fitting. Pipe should enter fitting socket from 1/3 to 3/4 depth of socket.

**Step 5** Apply a light coat of ABS solvent cement to inside of socket using straight outward strokes (to keep excess solvent out of socket).

This is also to prevent solvent cement damage to pipe. For loose fits, apply a second coat of solvent cement. Time is

important at this stage. See Section 316.1.3.

- Step 6 While both the inside socket surface and the outside surface of the pipe are SOFT and WET with solvent cement, forcefully bottom the pipe in the socket, giving the pipe a one-quarter turn, if possible. The pipe must go to the bottom of the socket.
- Step 7 Hold the joint together until tight (partial set).
- Step 8 Wipe excess cement from the pipe. A properly made joint will normally show a bead around its entire perimeter. Any gaps may indicate insufficient cement or the use of light-bodied cement on larger diameters where heavy-bodied cement should have been used.
- Step 9 The system shall not be tested until the joints have cured (set) at least as long as recommended by the manufacturer.

## **316.2 Special Joints**

### **316.2.1 Connection to Non-Plastic Pipe**

When connecting plastic pipe to other types of piping, use only approved types of fittings and adapters, designed for the specific transition intended.

**ADOPTED: 1976**

**REVISED: 1981, 1987**

**Installation Standard  
For  
POLYETHYLENE (PE) FOR GAS YARD PIPING**

**IAPMO IS 12-93**

This standard shall govern the installation of polyethylene (PE) natural and liquefied petroleum gas yard piping. Installation, material, and inspection shall comply with the current edition of the Uniform Plumbing Code published by the International Association of Plumbing and Mechanical Officials and shall also comply with this standard.

*Note: The following sections of the Uniform Plumbing Code apply to PE gas piping.*

202.0	Definition of PE
Table 14-1	Materials: Pipe and Tube
	PE3406 PE3408 ASTM D 2513-94a
	PE2306 PE2406
	Fittings: Copper Alloy ANSI B16.26-88
	PE2306, PE3408 PE2406 PE3406 ASTM D 2513-94a
310.0	Workmanship
313.0	Protection of Piping, Materials, and Structures
314.0	Supporting in the Ground
315.0	Backfilling
316.2.3	Connection to Other Materials
Chapter 12	Fuel Gas Piping
1204.0	Testing
1210.1	Location of PE
1211.16	Tracer Wire
1213.0	Liquefied Petroleum Gas Facilities and Piping
1218.0	Definition of medium pressure gas

**Chapter 2 Definitions**

Chapter 14

ANSI	American National Standards Institute
ASTM	American Society for Testing and Materials

IAPMO International Association of  
Plumbing and Mechanical Officials  
UPC Uniform Plumbing Code published  
by IAPMO

**301.1**

**Minimum Standards**

**301.1.1**

**Materials.** Pipe, tubing, and fittings shall conform to the appropriate standards in Table 14-1 of the Uniform Plumbing Code. See note ahead of Chapter 2 of this standard.

**301.1.1.1**

**Pipe.** PE pipe is plastic of 1/2 inch (12.7 mm) or larger size. One-half inch (12.7 mm) pipe shall be SDR 9. Pipe sizes less than 3 inches (76 mm) shall be SDR 11. Pipes 3 inches (76 mm) and larger shall be SDR 11.5 or lower\*.

**301.1.1.2**

**Tubing.** PE tubing is plastic and shall be limited to the following:

Tubing Size		
Inches	(mm)	SDR*
1/4	(6.4)	6
3/8	(9.5)	8
1/2	(12.7)	7

*\*Note: The lower the SDR number, the thicker the wall.*

**301.1.1.3**

**Fittings.** Heat fusion fittings shall be PE 2306, PE 2406, PE 3408, PE 3406, or other listed materials. Mechanical connectors for PE pipe and tubing and for transition fittings shall be approved compression-type couplings or other special listed joints.

**301.1.2**

**Markings**

**301.1.2.1**

**Pipe and Tubing.** Pipe and tubing shall be marked at intervals of not more than 2 feet (610 mm) with at least the following:

- (a) Manufacturer's name or trademark;
- (b) ASTM D 2513;
- (c) Pipe or tubing size;
- (d) PE 3406, PE 2306, PE 2406, or PE

- 3408;
- (e) "SDR" number\*;
  - (f) Gas;
  - (g) Quality control identification markings; and
  - (h) Pipe and tubing listed by IAPMO that is covered by this standard shall be labeled with the designated IAPMO certification mark to show conformance with this standard.
- 301.1.2.2 Fittings.** Fittings shall be marked with at least the following:
- (a) Manufacturer's name or trademark;
  - (b) Size;
  - (c) Material designation; and
  - (d) Fittings listed by IAPMO that are covered by this standard shall be labeled with the designated IAPMO certification mark to show compliance with this standard.
- 301.1.3 Position of Markings.** The identifying markings on pipe, tubing, and fittings shall be visible for inspection without moving materials.
- 313.0 Protection of Piping**
- 313.1 Storage.** Unprotected pipe should not be stored in direct sunlight. The pipe shall be stored in a way to protect it from mechanical damage (slitting, puncturing, etc.). Exposure to sunlight during normal construction periods is not harmful.
- 313.2 Thermal Expansion**
- 313.2.1 Snaking.** The pipe and tubing shall be snaked in the trench bottom with enough slack to provide for thermal expansion and contraction before stabilizing. The normal slack created by residual coiling is generally sufficient for this purpose. If, however, the pipe has been allowed to straighten before it is placed in the trench, 6 inches (152 mm) per 100 feet (30480 mm) of pipe length shall be allowed for this purpose.
- 313.2.2 Stabilizing.** Pipe and tubing temperature shall be stabilized by one of the following methods:
- (a) Shade backfill. Leave all joints exposed so they can be examined during the pressure test.

- (b) Allow to stand overnight.

### **315.0 Trenching and Backfill**

**315.1 Trenching.** Trench bottoms shall be smooth and regular of either undisturbed soil or a layer of compacted backfill so that minimum settlement will take place. Pipe or tubing shall not be wedged or blocked. Voids shall be filled and compacted to level of trench bottom. The minimum cover shall be 18 inches (457 mm) below finish grade.

*Exceptions: (1) Tubing for gas lights shall be buried a minimum of 12 inches (305 mm) below finish grade where gas flow is restricted to 10 cubic feet per hour ( $8 \times 10^{-5}$  m<sup>3</sup>/s) at its source by a mechanical means or a fixed orifice.*

*Note: Local climactic conditions may affect required burial depth.*

*(2) Piping may terminate a maximum of 1 foot above ground when encased in a listed anodeless transition riser.*

**315.2 Backfill.** The pipe and tubing temperature shall be stabilized before backfilling. See Section 313.2.2.

### **316.0 Types of Joints**

PE joints shall be made as follows:

**316.1.1 Heat Fusion Joints.** Heat fusion joints shall be made according to the manufacturer's procedures using recommended heat times, temperature, and joining pressures.

**316.2 Mechanical Joints.** Mechanical joints shall be assembled in an approved manner with tools recommended by the fitting manufacturer. Mechanical joints shall be made with listed mechanical fittings.

### **316.3 Special Joints**

**316.3.1** Listed transition fittings or listed mechanical fittings shall be used when making joints between PE and steel or PE and copper.

**316.3.2** Transition fittings shall be installed outside of meter vaults with metallic piping extending into the vaults a sufficient distance to permit the use of backup wrenches.

**1204.0 Inspections**

**1204.1 Temperature.** Pipe temperatures shall be stabilized before testing. See Section 313.2.2.

**1204.1.1** Piping shall be subjected to the pressure test required in Section 1204.0 of the Uniform Plumbing Code.

**1210.0 Materials**

**1210.1 Location.** PE pipe and tubing shall be installed only outside the foundation of any building, structure, parts thereof. It shall be buried in the ground for its entire length with cover as provided in Section 315.1 of this

standard. It shall not be installed within or under any building structure, mobile home, commercial coach, parts thereof. The term "building or structure or parts thereof" shall include structures such as porches and steps, whether covered or uncovered, roofed porte cocheres, roofed patios, carports, covered walks, covered driveways, and similar structures or appurtenances.

*Exception: Tubing may extend into gas light support columns provided it is not exposed to external damage.*

**1210.2 Maximum Working Pressure.** Gas pressure shall not be more than 5 psi (34.5 kPa) for natural gas nor more than

**TABLE 1217.2  
SIZE OF PLASTIC GAS TUBING**

Maximum Delivery Capacity in Cubic Feet of Gas per Hour (CFH)  
of Tubing Carrying Natural Gas of 0.60 Specific Gravity

Nominal Tubing Size Inches	Internal Diameter Inches	Length in Feet											
		10	20	30	40	50	60	70	80	90	100	125	
1/4	0.250	18	12	10	8	7	7	6	6	5	5	4	
3/8	0.375	51	35	28	24	21	19	18	16	16	15	13	
		<b>150</b>	<b>200</b>	<b>250</b>	<b>300</b>	<b>350</b>	<b>400</b>	<b>450</b>	<b>500</b>	<b>550</b>	<b>600</b>		
1/4	0.250	4	3	3	3	3	2	2	2	2	2		
3/8	0.375	12	10	9	8	7	7	6	6	6	6		

**TABLE 1217.2 (Metric)  
SIZE OF PLASTIC GAS TUBING**

Maximum Delivery Capacity in Cubic Meters of Gas per Second (m<sup>3</sup>/s)  
of Tubing Carrying Natural Gas of 0.60 Specific Gravity

Nominal Tubing Size mm	Internal Diameter mm	Length in Meters							
		3.0	6.1	9.1	12.2	15.2	18.3		
6.4	6.4	1.4	1.0	0.8	0.6	0.56	0.56		
9.5	9.5	4.1	2.8	2.2	1.9	1.7	1.5		
		<b>21.3</b>	<b>24.4</b>	<b>27.4</b>	<b>30.5</b>	<b>38.1</b>	<b>45.7</b>		
6.4	6.4	0.5	0.5	0.4	0.4	0.3	0.3		
9.5	9.5	1.4	1.3	1.2	1.2	1.0	0.96		
		<b>61.0</b>	<b>76.2</b>	<b>91.4</b>	<b>106.7</b>	<b>121.9</b>	<b>137.2</b>		
6.4	6.4	0.2	0.2	0.2	0.2	0.16	0.16		
9.5	9.5	0.8	0.7	0.6	0.56	0.56	0.5		
		<b>152.4</b>	<b>167.6</b>	<b>182.9</b>					
6.4	6.4	0.16	0.16	0.16					
9.5	9.5	0.5	0.5	0.5					

10 psi (69 kPa) for liquefied petroleum gas.

**1210.3 Gas Supplier.** Installation shall be acceptable to the serving gas supplier.

**1211.0 Installation of Gas Piping**

**1211.1 Types of Joints.** See Sections 316.0 and 316.3 of this standard.

**1211.2 Prohibited Joints.** PE pipe shall not be joined by threaded joints. Joints made with adhesives or solvent cement shall be prohibited.

**1211.3 Identification.** Plastic gas yard piping shall be permanently identified by attaching a metal tag to the meter end of the piping system stating, "Plastic Yard Piping."

**1217.0 Sizing**

**1217.1 Pipe.** Pipe shall be sized as required by Section 1217.0 or 1218.0 of the UPC.

**1217.2 Tubing.** Tubing shall be sized from Table 1217.2.

**ADOPTED: 1971**

**REVISED: 1975, 1977, 1978, 1981, 1983, 1985, 1989, 1990, 1991, 1993**

**Installation Standard  
For  
PROTECTIVELY COATED PIPE**

**IAPMO IS 13-2000**

Installation and material of protective pipe coatings shall comply with this standard and the current edition of the Uniform Plumbing Code published by the International Association of Plumbing and Mechanical Officials (IAPMO).

*Note: The following sections of the Uniform Plumbing Code shall apply to protectively coated pipe.*

- 301.1 Marking and labeling
- 302.0 Wrought iron and steel pipe sizing
- 310.0 Workmanship
- 311.0 Prohibited fittings and practices
- 313.5 Protection required
- 314.0 Burial of piping
- 604.0 Materials – water piping
- 609.3.1 Coated protection required
- 1210.0 Materials – gas piping
- 1211.5 Coated protection required
- 1211.6 Coating material approval required

**301.1 Minimum Standards**

**301.1.1 Materials**

**301.1.1.1 Coating.** Piping shall be coated by a listed coating applicator in accordance with AWWA C203, AWWA C213, or AWWA C215.

**301.1.1.2 Tape.** Tape for field application shall comply with PS-37-90, Black Plastic PVC or PE Pressure-Sensitive Corrosion Preventive Tape.

**301.1.1.3 Primer.** Primer for field application shall be compatible with the tape and be as recommended by the tape manufacturer.

**301.1.2 Markings**

**301.1.2.1 Pipe.** Protectively coated pipe shall be legibly marked at least every two (2) feet (610 mm) with the following:

- (a) Applicator's name or trademark;
- (b) Pipe manufacturer's name;

- (c) Pipe standard designation, i.e., ASTM or API;
- (d) Pipe material type, i.e., black, galvanized;
- (e) Pipe size and schedule;
- (f) Coating material;
- (g) Holiday test voltage;
- (h) Products listed by IAPMO that are covered by this standard shall be labeled with the designated IAPMO certification mark; and
- (i) Any other required markings.

**301.1.2.2**

**Tape.** Tape for field applications should be legibly marked at least every two (2) feet (610 mm) with the manufacturer's name and tape model identification.

**313.0**

**313.1**

**Protection of Piping and Fittings**

**Field Joints.** Field joints shall be made as follows, except as specified in Section 313.2. Clean and dry surfaces to be protected.

**Step 1** Remove oil and grease, if present, with suitable non-oily type solvent such as heptane or trichlorethylene. Materials such as kerosene and gasoline shall not be used.

**Step 2** For coated pipe, remove coating approximately 3 inches (76 mm) from end of pipe or from repair area, and bevel to expose shoulder of coating at area to be field wrapped.

**Step 3** For taped pipe, remove tape and overwrapping so as to expose approximately 3 inches (76 mm) of pipe at area to be field wrapped.

**Step 4** For welded pipe, grind down sharp welds and weld spatter to a minimum 1/8 inch (3.2 mm) radius.



- Wire brush the weld area thoroughly, taking care to remove as much mil scale and surface rust as possible. Remove any loose or charred coating caused during welding.
- Step 5 Apply listed primer as recommended by the manufacturer of the tape being applied over the protected area and adjacent 1 inch (25.4 mm) of protected area.
- Step 6 Spirally wrap listed tape by a half overlap double wrap of minimum 10 mil tape stretched around the fitting, thread, and other unprotected areas to provide a minimum 40 mil thickness. A maximum of two (2) inch (51 mm) wide tape shall be used for field application.
- Exception:** Unless otherwise listed by IAPMO, a maximum of one (1) inch (25.4 mm) wide tape shall be used on change-of-direction fittings for piping sizes up to and including two (2) inch (51 mm).
- 313.2 Other Methods.** Other materials approved for field joints or repair shall be applied as per manufacturer's recommendations and the listing requirements.
- 313.3 Damage in Shipment.** Coated piping shall be protected against damage in shipment.
- 313.4 Handling and Storage.** Coated piping shall be handled and stored in a manner to prevent damage.
- 313.5 Handling by Installer.** Movement of pipe from truck or into trench shall be done in such a manner as to avoid abrasion or damage from dropping.
- 315.0 Backfill.** All excavations shall be completely backfilled as soon after inspection as possible.
- 1211.7 Inspection.** All coated piping shall be inspected and tested; and any visible void, damage, or imperfection to the pipe coating shall be repaired so as to comply with Section 313.0.
- 1211.7.1 Equipment.** The equipment, material, and labor necessary for inspection or tests shall be furnished by the person to whom the permit is issued or by whom inspection is requested.
- ADOPTED: 1971**  
**REVISED: 1975, 1978, 1982, 1984, 1991, 2000**

**Installation Standard  
For  
ASBESTOS CEMENT PRESSURE PIPE FOR WATER SERVICE AND YARD PIPING**

**IAPMO IS 15-82**

This standard shall govern the installation of asbestos cement pressure pipe and fittings with elastomeric gasketed joints in hot and cold water building supply and yard piping. For allowable location and pressure, see Sections 604.1 and 609.1.2 of this standard. Installation, material, and inspection shall comply with this standard and the current edition of the Uniform Plumbing Code published by the International Association of Plumbing and Mechanical Officials.

*Note: The following sections of the Uniform Plumbing Code apply to asbestos cement pressure piping systems.*

Table 14-1	Materials
310.0	Workmanship
313.0	Protection of Piping, Materials, and Structures
314.0	Supporting in the Ground
315.0	Backfilling
Chapter 6	Water Distribution

**Chapter 2 Definitions**

202.0	AC	Asbestos Cement
Chapter 14	ASTM	American Society for Testing and Materials
	IAPMO	International Association of Plumbing and Mechanical Officials
	UPC	Uniform Plumbing Code published by IAPMO

**301.1 Minimum Standards**

**301.1.1 Material.** Materials shall conform to the appropriate standard in Table 14-1 of the Uniform Plumbing Code.

Applicable Standards

- AC Pipe ASTM C296-93
- Fittings AWWA/ANSI A21.10-93
- Rings ASTM D1869-94
- Joints AWWA/ANSI A21.11-93

**301.1.1.1 Pipe.** Pipe is asbestos cement.

**301.1.1.2 Fittings.** Fittings are cast iron or other listed materials.

**301.1.2 Markings**

**301.1.2.1 Pipe.** Each uncut length of pipe shall be marked with at least the following:

- (a) Manufacturer's name or trademark;
- (b) Size and class;
- (c) Date of manufacture;
- (d) Test pressure; and
- (e) Pipe listed by IAPMO that is covered by this standard shall be labeled with the designated IAPMO certification mark to show compliance with this standard.

**301.1.2.2 Fittings.** Fittings should be marked with at least the following:

- (a) Initials of makers name;
- (b) Year of casting;
- (c) Nominal diameter; and
- (d) Weight and class.

**301.1.2.3 Couplings.** Couplings shall be marked with at least the following:

- (a) Manufacturer's name or trademark;
- (b) Class and nominal size; and
- (c) Letter "T".

**301.1.3 Position of Markings.** The identifying markings on pipe and fittings shall be visible for inspection without moving materials unless otherwise acceptable to the Administrative Authority.

**315.0 Trenching, Cover, and Backfill**

**315.1 Trenching and Cover.** Trench bottoms shall be uniformly graded and shall be of either undisturbed soil or shall consist of a layer or layers of compacted backfill so that minimum settlement will take place.

The trench bottoms shall be at least 12 inches (305mm) below the average local frost depth. The minimum cover shall be 18 inches (458 mm) below the finish grade.

**315.2 Backfill.** After finishing pressure testing of the line, backfill a minimum of twelve (12) inches (305 mm) deep over the top of the pipe and fittings. Backfill should be select material placed

around the pipe in a manner to provide a firm continuous support. Tamp well to secure proper compaction.

*Note: All joints shall be exposed during test.*

**705.0 Joints**

**705.1** Joints in asbestos cement pipe shall be a sleeve coupling of the same composition as the pipe or other listed materials, sealed with rubber rings or joined by other listed compression type coupling.

**705.1.1** Joints between asbestos cement pipe and other approved pipes shall be made by means of listed adapter couplings. Special heat-resistant rings as recommended by the manufacturer must be used for temperatures in excess of 140°F (60°C).

**705.2** Before assembling the joint, the coupling grooves, pipe ends, and rubber gasket must be cleaned. The rubber gaskets are then positioned in the grooves.

**705.2.1** Use the pipe manufacturer's joint lubricant recommended for potable water application. Apply lubricant to the machined end of the pipe only, never to the rubber gasket or groove unless specifically recommended otherwise by the manufacturer.

**705.2.2** The end of the pipe and the coupling or fitting bell shall be assembled using a bar and wood block or a pipe puller. Stabbing or popping the pipe into the coupling (pipe is suspended and swung into the bell) is not recommended.

**705.3** When a field cut is made, cut the pipe square, with hand pipecutters which use a cutting edge, or hand saws. To properly enter the rubber-gasketed joint, the end of the pipe must be machined before insertion, using hand machining tools.

**604.0 Materials**

**604.1 Location.** Asbestos cement piping shall be installed only outside the foundation of any building, structure, or parts thereof. It shall be buried in the ground for its entire length, except vertical piping may be extended above grade per Section 313.0 of the Uniform Plumbing Code. It shall not be installed

within or under any building, structure, mobile home, commercial coach, or parts thereof. The term building or structure or parts thereof shall include structures such as porches and steps, roofed porte cocheres, roofed patios, carports, covered walks, covered driveways, and similar structures or appurtenances.

**609.0 Installation, Testing, and Identification**

**609.1 Installation**

**609.1.1 Alignment and Deflection.** Pipe and fittings shall be aligned properly without strain. Pipe may be deflected in accordance with the manufacturer's recommendations provided that it shall not be permanently staked or blocked to maintain this deflection. If soft soil conditions exist, deflected joints may be permanently blocked or staked to maintain the deflection. The amount of deflection shall be 5° for sizes 4 inch (101.6 mm) through 12 inch (305 mm); 4° for 14 inch (356 mm) through 16 inch (407 mm); 3-1/2° for 18 inch (457 mm) through 24 inch (610 mm) for pipe belled on the job site. For factory-belled couplings, one half (1/2) the above deflections by size shall be allowed.

**609.1.2 Working Pressure.** Maximum working pressure shall be as follows:

**Materials, Sizes and Maximum Working Pressures**

Pipe	Size	Maximum Pressure
Class 100	4 – 24 inch incl.	100 psi
	(102 – 610 mm incl.)	(689 kPa)
Class 150	4 – 24 inch incl.	150 psi
	(102 – 610 mm incl.)	(1033 kPa)
Class 200	4 – 24 inch incl.	200 psi
	(102 – 610 mm incl.)	(1378 kPa)

**609.1.3 Laterals and Saddles.** Installation of laterals, saddles, or tapped couplings in AC piping shall be as required by their listings.

**609.1.4 Thrust Blocking.** Thrust blocks shall be installed at:

- (a) Changes in direction, as at tees and bends;
- (b) Changes in size, as at reducers;
- (c) Stops, as at dead ends; and
- (d) Valves, where thrusts may be expected.

The size and type of thrust block shall be based on the pressure rating of the pipe (or line test pressure, if greater than piping rating), pipe size, and kind of soil; refer to 609.1.4(b). Refer to Table

- 609.1.4(a) for thrust at fittings for a pressure of one hundred (100) pounds per square inch (689 kPa).
- 609.1.5** To determine the bearing area of thrust blocks, refer to Table 609.1.4(b) for the safe bearing load of the soil, and divide the total thrust by this safe bearing load.
- 609.1.6** Thrust blocks shall be located as shown on Chart 609.1.4(c).
- 609.2 Testing**

**TABLE 609.1.4 (a)**  
**Thrust at Fittings in Pounds at 100 psi of Water Pressure**

Pipe Size	Class	Dead Ends and Tees			
		90° Bend	45° Bend	22 1/2° Bend	
4"	100	1,720	2,440	1,320	660
	150	1,850	2,610	1,420	720
	200	1,850	2,610	1,420	720
6"	100	3,800	5,370	2,910	1,470
	150	3,800	5,370	2,910	1,470
	200	3,800	5,370	2,910	1,470
8"	100	6,580	9,300	5,040	2,550
	150	6,580	9,300	5,040	2,550
	200	6,580	9,300	5,040	2,550
10"	100	9,380	13,270	7,190	3,640
	150	10,750	15,200	8,240	4,170
	200	10,750	15,200	8,240	4,170
12"	100	13,330	18,860	10,240	5,170
	150	15,310	21,640	11,720	5,940
	200	15,310	21,640	11,720	5,940
14"	100	17,930	23,360	13,740	6,960
	150	20,770	29,360	15,910	8,060
	200	20,770	29,360	15,910	8,060
16"	100	23,210	32,820	17,880	9,000
	150	26,880	38,010	20,590	10,430
	200	26,880	38,010	20,590	10,430
18"	100	31,000	44,200	23,850	11,950
	150	34,400	48,500	26,400	13,400
	200	38,600	54,400	29,650	14,900
20"	100	38,400	54,200	29,500	14,700
	150	42,600	60,000	32,600	16,500
	200	47,800	67,400	36,700	18,600
24"	100	55,000	78,000	42,200	21,100
	150	61,500	86,700	47,200	23,900
	200	69,000	97,200	52,900	26,800

**TABLE 609.1.4 (a) (Metric)**  
**Thrust at Fittings in Newtons at 689 kPa of Water Pressure**

Pipe Size	Class	Dead Ends and Tees			
		90° Bend	45° Bend	22 1/2° Bend	
102	100	7654	10,858	5874	2937
	150	8232.5	11,614.5	6319	3204
	200	8232.5	11,614.5	6319	3204
152	100	16,910	23,896.5	12,949.5	6541.5
	150	16,910	23,896.5	12,949.5	6541.5
	200	16,910	23,896.5	12,949.5	6541.5
203	100	29,281	41,385	22,428	11,347.5
	150	29,281	41,385	22,428	11,347.5
	200	29,281	41,385	22,428	11,347.5
254	100	41,741	59,051.5	31,995.5	16,198
	150	47,837.5	67,640	36,668	18,556.5
	200	47,837.5	67,640	36,668	18,556.5
305	100	59,318.5	83,927	45,568	23,006.5
	150	68,129.5	96,298	52,154	26,433
	200	68,129.5	96,298	52,154	26,433
356	100	79,788.5	103,952	61,143	30,973
	150	92,426.5	130,652	70,799.5	35,867
	200	92,426.5	130,652	70,799.5	35,867
406	100	103,284.5	146,049	79,566	40,050
	150	119,616	169,144.5	91,625.5	46,413.5
	200	119,616	169,144.5	91,625.5	46,413.5
457	100	137,950	196,690	106,132.5	53,177.5
	150	153,080	215,825	117,480	59,630
	200	171,770	242,080	131,942.5	66,305
508	100	170,880	241,190	131,275	65,415
	150	189,570	267,000	145,070	73,425
	200	212,710	299,930	163,315	82,770
610	100	244,750	347,100	187,790	93,895
	150	273,675	385,815	210,040	106,355
	200	307,050	432,540	235,405	119,260

**609.2.1** The portion of the line being tested should be complete with thrust blocks or properly sized temporary thrust blocking. The line may be pressure tested immediately after installation, provided however, that if poured concrete thrust blocks have been utilized, they have had a 24-hour period to attain an initial cure.

**609.2.2** The entire system shall be filled with water, purged of air, and tested at a pressure at least equal to the eventual operating pressure for at least one (1) hour before inspection and backfilling of trench. It is recommended that the test pressure not exceed the working pressure of the pipe.

**CAUTION: Air Testing is Prohibited.**

**609.2.3 Identification.** A label shall be fastened to the main electrical meter panel

stating, "This structure has a non-metallic water service."

**610.0 Sizing.** Piping shall be sized in accordance with UPC Section 610.0. When UPC Appendix A is applicable, Chart A-5 (Fairly Smooth Pipe) may be used. Flow velocities shall be limited to a maximum of 8 fps (2.4 m/s). When using UPC, Table 6-3, required by UPC Section 610.0, velocities shall also be checked and limited using UPC Chart A-5.

*Example:* For a pressure of 150 psi (1033.5 kPa) on a 4 inch (102 mm) tee, Table 609.1.4(a) indicates 1850 pounds (8232.5N) for 100 psi (689 kPa). Therefore, total thrust for 150 psi (1033.5 kPa) will equal 1-1/2 times 1850 pounds (8232.5 N).

**CHART 609.1.4 (C)**

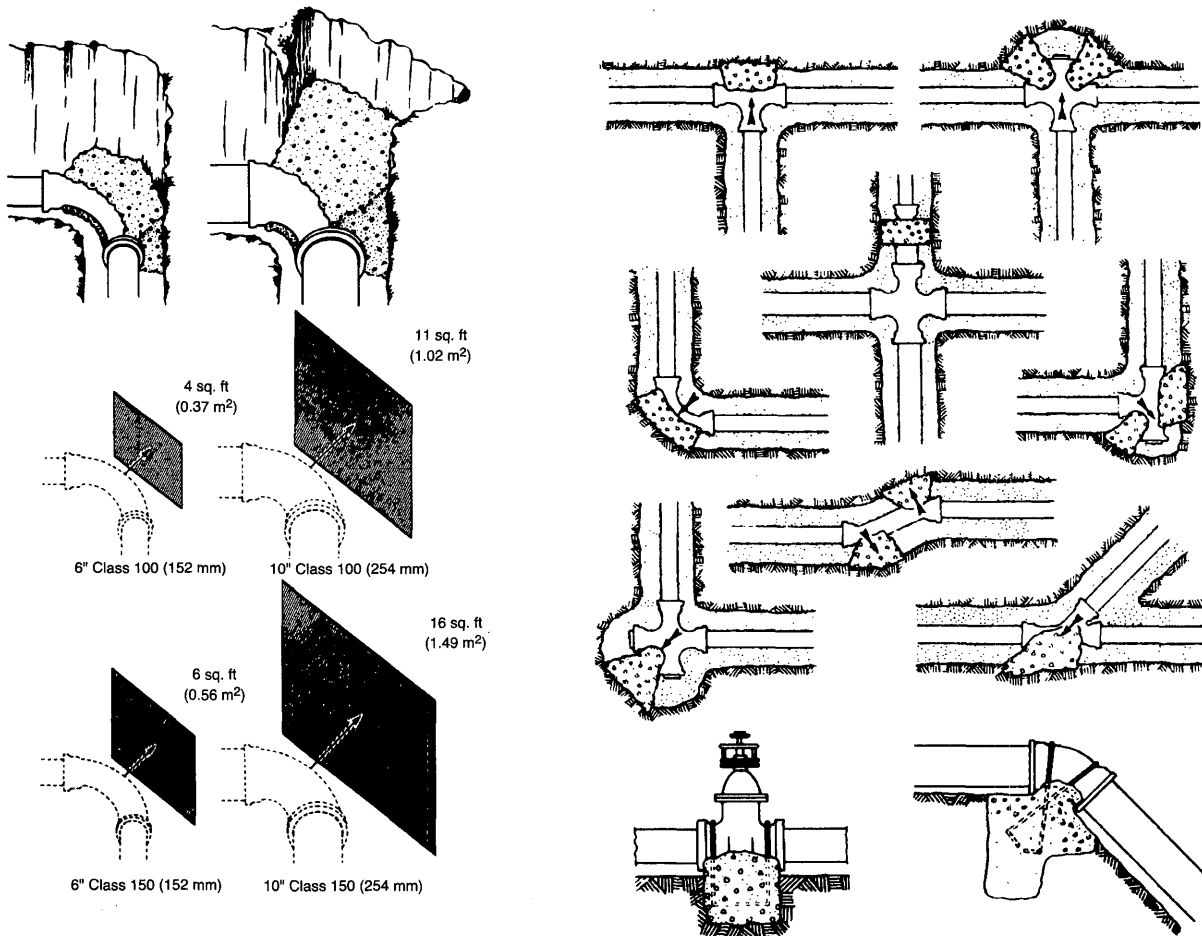

**TABLE 609.1.4(b)**  
**Safe Bearing Loads for Various Soils**

Soil	Safe Bearing Load	
	Lbs./Sq. Ft.	(kPa)
Mulch, Peat, etc.	0	0
Soft Clay	1000	6890
Sand	2000	13,780
Sand and Gravel	3000	20,670
Sand and Gravel		
Cemented w/Clay	4000	27,360
Hard Shale	10,000	68,900

*Example:* Assume a 4000 pound (17,800 N) total thrust was computed. The soil condition is sand. The required bearing area of the thrust block is 4000 lbs. (17,800 N) divided by 2000 lbs. (13,780 kPa), or 2 sq. ft (0.19 m<sup>2</sup>)

**ADOPTED: 1975**

**REVISED: 1981, 1982**

**Installation Standard  
For  
LOW-PRESSURE AIR TEST FOR BUILDING SEWERS**

**IAPMO IS 16-84**

This Installation Test Standard is for use with sewer piping materials as listed in Table 14-1, Chapter 14, current edition of the Uniform Plumbing Code published by the International Association of Plumbing and Mechanical Officials, hereafter referred to as IAPMO.

*Note: The following section of the Uniform Plumbing Code applies to this test:*

**723.0 Testing**

**1. Purpose:**

**1.1** This Standard defines procedures for testing sewer lines using low pressure air to demonstrate the integrity of the installed material and the construction procedures. This recommended practice is for use in testing 3 inch (76 mm) through 12 inch (305 mm) building sewer lines only.

**2. General Requirement:**

**2.1** The section of the building sewer line to be tested is plugged. Air at low pressure is introduced into the plugged line. The calculated test time for the pressure to drop is measured.

**3. Procedure:**

**Step 1** Plug all pipe outlets to resist the test pressure. Give special attention to stoppers and laterals.

**Step 2** Determine the test duration for the section under test from table provided. The pressure holding time is based on an average holding pressure of 3 psi (21 kPa) gauge or a drop from 3.5 psi (24 kPa) to 2.5 psi (17 kPa) gauge.

**Step 3** Add air until the internal air pressure of the sewer line is raised to approximately 4.0 psi (28 kPa) gauge. After an internal pressure of approximately 4.0 psig (28 kPa) is obtained, allow time for the air pressure to stabilize. The pressure will normally show some drop until

the temperature of the air in the test section stabilizes.

**Step 4** When the pressure has stabilized and is at or above the starting test pressure of 3.5 psi (24 kPa) gauge, commence the test. Before starting the test, the pressure may be allowed to drop to 3.5 psig (24 kPa). Record this drop in pressure for the test period. If the pressure has dropped more than 1.0 psi (7 kPa) gauge during the test period, the line is presumed to have failed. The test may be discontinued when the prescribed test time has been completed even though the 1.0 psig (7 kPa) drop has not occurred.

**4.0 Safety:**

**4.1** The air test may be dangerous if, because of lack of understanding or carelessness, a line is improperly prepared. It is extremely important that the various plugs be installed and braced to prevent blowouts.



**SAMPLE AIR TEST TABLE**

Minimum time, in seconds, for pressure to drop from  
3-1/2 (24 kPa) to 2-1/2 (17 kPa) PSI

ft x 304.8 = mm

Length of Line (feet)	3-4 in. 76.2- (m) 101.6 mm	6 in. 152.4 mm	8 in. 203.2 mm	10 in. 254 mm	12 in. 304.8 mm	
						25
50	15.2	30	30	35	55	79
75	22.9	30	30	53	83	119
100	30.5	30	40	70	110	158
125	38.1	30	50	88	138	198
150	45.7	30	59	106	165	238
175	53.3	31	69	123	193	277
200	61	35	79	141	220	317
225	68.6	40	89	158	248	340
250	76.2	44	99	176	275	340
275	83.8	48	109	194	283	340
300	91.4	53	119	211	283	340
325	99.1	57	129	227	283	340
350	106.7	62	139	227	283	340
375	114.3	66	148	227	283	340
400	121.9	70	158	227	283	362
450	137.2	79	170	227	283	407
500	152.4	88	170	227	314	452

LENGTH OF MAIN LINE IN FEET (m)      6" (152 mm) DIAMETER

		25	50	75	100	125	150	175	200	225	250	275	300	400	500	
		7.6	15.2	22.9	30.5	38.1	45.7	53.3	61	68.6	76.2	83.8	91.4	121.9	152.4	
LENGTH OF LATERAL IN FEET (m) 3" or 4" (76.2-101.6 mm) DIAMETER	25	7.6	30	24	34	44	54	64	74	84	94	103	113	123	163	168
	50	15.2	30	29	39	48	58	68	78	88	98	108	118	128	166	167
	75	22.9	30	33	43	53	63	73	83	92	102	112	122	132	164	165
	100	30.5	30	37	47	57	67	77	87	97	107	117	127	136	162	163
	125	38.1	32	42	52	62	72	81	91	101	111	121	131	141	160	162
	150	45.7	36	46	56	66	76	86	96	106	116	125	135	145	159	161
	175	53.3	41	51	61	70	80	90	100	110	120	130	140	150	157	159
	200	61	45	55	65	75	85	95	105	114	124	134	144	153	156	158
	225	68.6	50	59	69	79	89	99	109	119	129	139	149	151	154	157
	250	76.2	54	64	74	84	94	103	113	123	133	143	149	150	153	156
	275	83.8	58	68	78	88	98	108	118	128	138	146	147	149	152	155
	300	91.4	63	73	83	92	102	112	122	132	142	145	146	147	151	154
	350	106.7	72	81	91	101	111	121	131	140	141	143	144	145	149	152
	400	121.9	80	90	100	110	120	130	136	138	139	141	142	143	147	150
	450	137.2	89	99	109	119	129	132	134	136	138	139	141	142	145	149
	500	152.4	98	108	118	126	129	131	133	135	136	138	139	140	144	147

NO HOLDING TIME LESS THAN 30 SECONDS

LENGTH OF MAIN LINE IN FEET (m)      8" (203 mm) DIAMETER

		25	50	75	100	125	150	175	200	225	250	275	300	400	500	
		7.6	15.2	22.9	30.5	38.1	45.7	53.3	61	68.6	76.2	83.8	91.4	121.9	152.4	
LENGTH OF LATERAL IN FEET (m) 3" or 4" (76.2-101.6 mm) DIAMETER	25	7.6	30	40	57	75	92	110	128	145	163	180	198	216	223	224
	50	15.2	30	44	62	79	97	114	132	150	167	185	202	218	220	221
	75	22.9	31	48	66	84	101	119	136	154	172	189	207	214	217	219
	100	30.5	35	53	70	88	106	123	141	158	176	194	209	211	214	216
	125	38.1	40	57	75	92	110	128	145	163	180	198	206	207	211	214
	150	45.7	44	62	79	97	114	132	150	167	185	201	202	204	209	212
	175	53.3	48	66	84	101	119	136	154	172	189	197	199	201	206	210
	200	61	53	70	88	106	123	141	158	176	192	194	197	199	204	208
	225	68.6	57	75	92	110	128	145	163	180	189	192	194	196	202	206
	250	76.2	62	79	97	114	132	150	167	183	186	189	191	193	200	204
	275	83.8	66	84	101	119	136	154	172	181	184	187	189	191	198	202
	300	91.4	70	88	106	123	141	158	174	178	181	184	187	189	196	200
	350	106.7	79	97	114	132	150	166	170	174	177	180	183	185	192	197
	400	121.9	88	106	123	141	157	162	166	170	174	176	179	181	189	194
	450	137.2	97	114	132	148	154	159	163	167	170	173	176	178	186	191
	500	152.4	106	123	140	146	151	156	160	164	167	170	173	175	183	189

NO HOLDING TIME LESS THAN 30 SECONDS

		LENGTH OF MAIN LINE IN FEET (m)										8" (203 mm) DIAMETER																		
		25	50	75	100	125	150	175	200	225	250	275	300	400	500	7.6	15.2	22.9	30.5	38.1	45.7	53.3	61	68.6	76.2	83.8	91.4	121.9	152.4	
LENGTH OF LATERAL IN FEET (m) 6" (152.4 mm) DIAMETER	25	7.6	30	45	63	80	98	116	133	151	168	186	204	221	224	225														
	50	15.2	37	55	73	90	108	126	143	161	178	196	214	220	222	223														
	75	22.9	47	65	83	100	118	135	153	171	188	206	217	217	220	221														
	100	30.5	57	75	93	110	128	145	163	181	198	214	214	215	218	220														
	125	38.1	67	85	102	120	138	155	173	190	208	211	212	213	216	218														
	150	45.7	77	95	112	130	148	165	182	200	207	209	210	211	214	217														
	175	53.3	87	105	122	140	157	175	192	204	206	207	208	209	214	215														
	200	61	97	114	132	150	167	185	201	202	204	205	206	207	211	214														
	225	68.6	107	124	142	160	177	195	199	201	203	204	205	206	210	213														
	250	76.2	117	134	152	169	187	195	198	199	201	202	203	204	209	212														
	275	83.8	127	144	162	179	192	194	196	198	200	201	202	204	208	210														
	300	91.4	136	154	172	187	190	192	195	196	198	200	201	202	207	209														
	350	106.7	156	174	181	185	187	190	193	194	196	198	199	200	205	208														
	400	121.9	173	178	181	184	186	189	191	192	194	196	197	198	203	206														
	450	137.2	173	177	180	183	185	187	189	190	192	194	195	196	201	204														
	500	152.4	173	177	180	182	184	186	188	189	191	192	193	194	200	203														

NO HOLDING TIME LESS THAN 30 SECONDS

		LENGTH OF MAIN LINE IN FEET (m)										10" (254 mm) DIAMETER																		
		25	50	75	100	125	150	175	200	225	250	275	300	400	500	7.6	15.2	22.9	30.5	38.1	45.7	53.3	61	68.6	76.2	83.8	91.4	121.9	152.4	
LENGTH OF LATERAL IN FEET (m) 4" (101.6 mm) DIAMETER	25	7.6	32	59	87	114	142	169	197	224	252	277	277	278	279	280														
	50	15.2	36	64	91	119	146	174	201	229	256	271	272	273	275	277														
	75	22.9	41	68	96	123	151	178	206	233	261	265	267	268	272	274														
	100	30.5	45	73	100	128	155	183	210	238	258	260	262	264	268	271														
	125	38.1	50	77	105	132	160	187	214	242	253	255	257	259	264	268														
	150	45.7	54	81	109	136	164	191	219	244	248	251	253	255	261	265														
	175	53.3	58	86	113	141	168	196	223	239	243	246	249	251	258	262														
	200	61	63	90	118	145	173	200	228	235	239	242	245	248	255	260														
	225	68.6	67	95	122	150	177	205	226	231	235	239	242	244	252	257														
	250	76.2	72	99	127	154	182	209	222	227	231	235	238	241	249	255														
	275	83.8	76	103	131	158	186	211	218	223	228	231	235	238	247	253														
	300	91.4	80	108	135	163	190	208	214	220	224	228	232	235	244	250														
	350	106.7	89	117	144	172	194	201	208	213	218	222	226	229	239	246														
	400	121.9	98	125	153	179	188	196	202	208	213	217	221	224	235	242														
	450	137.2	107	134	162	174	183	191	197	203	208	212	216	220	230	238														
	500	152.4	116	143	160	170	179	186	193	198	203	208	212	215	226	235														

NO HOLDING TIME LESS THAN 30 SECOND

		LENGTH OF MAIN LINE IN FEET (m)														
		10" (254 mm) DIAMETER														
		25	50	75	100	125	150	175	200	225	250	275	300	400	500	
		7.6	15.2	22.9	30.5	38.1	45.7	53.3	61	68.6	76.2	83.8	91.4	121.9	152.4	
LENGTH OF LATERAL IN FEET (m) 6" (152.4 mm) DIAMETER	25	7.6	37	65	92	120	147	175	202	230	257	277	278	278	279	280
	50	15.2	47	75	102	130	157	185	212	240	267	271	272	273	276	277
	75	22.9	57	85	112	140	167	195	222	250	265	266	267	269	272	274
	100	30.5	67	95	122	150	177	205	232	257	260	262	263	265	269	271
	125	38.1	77	105	132	160	187	215	242	253	255	257	259	261	266	269
	150	45.7	87	114	142	169	197	224	245	248	251	254	256	257	263	266
	175	53.3	97	124	152	179	207	234	241	245	248	250	252	254	260	264
	200	61	107	134	162	189	217	233	237	241	244	247	249	251	258	262
	225	68.6	117	144	172	199	225	230	234	238	241	244	246	248	255	260
	250	76.2	127	154	182	209	222	227	231	235	238	241	243	246	253	258
	275	83.8	136	164	191	213	219	224	229	232	236	238	241	243	251	256
	300	91.4	146	174	201	211	217	222	226	230	233	236	239	241	249	254
	350	106.7	166	192	200	207	212	217	222	226	229	232	235	237	245	250
	400	121.9	181	190	197	203	209	214	218	222	225	228	231	233	241	247
	450	137.2	180	188	195	201	206	211	215	218	222	225	227	230	238	244
	500	152.4	179	186	193	198	203	208	212	215	219	222	224	227	235	241

NO HOLDING TIME LESS THAN 30 SECONDS

		LENGTH OF MAIN LINE IN FEET (m)														
		10" (254 mm) DIAMETER														
		25	50	75	100	125	150	175	200	225	250	275	300	400	500	
		7.6	15.2	22.9	30.5	38.1	45.7	53.3	61	68.6	76.2	83.8	91.4	121.9	152.4	
LENGTH OF LATERAL IN FEET (m) 8" (203.2 mm) DIAMETER	25	7.6	45	73	100	128	155	183	210	238	265	279	280	280	281	281
	50	15.2	63	90	118	145	173	200	228	255	275	275	276	277	278	279
	75	22.9	80	108	135	163	190	218	245	270	272	272	273	274	276	277
	100	30.5	98	125	153	180	208	235	263	267	268	269	270	271	274	275
	125	38.1	116	143	171	198	226	253	263	265	266	267	268	269	272	274
	150	45.7	133	161	188	216	243	258	260	262	264	265	266	267	270	272
	175	53.3	151	178	206	233	254	256	258	260	262	263	264	265	268	271
	200	61	168	196	223	249	252	254	256	258	260	261	262	263	267	269
	225	68.6	186	213	241	247	250	253	255	257	258	259	261	262	265	268
	250	76.2	204	231	242	246	249	251	253	255	256	258	259	260	264	267
	275	83.8	221	237	241	244	247	250	252	254	255	256	258	259	263	266
	300	91.4	232	237	240	243	246	249	251	253	254	255	256	258	262	265
	350	106.7	232	235	239	242	244	247	249	251	252	253	254	256	260	263
	400	121.9	231	234	238	240	243	245	247	249	250	251	253	254	258	261
	450	137.2	230	234	237	239	241	243	245	247	248	250	251	252	256	259
	500	152.4	230	233	236	238	240	242	244	246	247	249	250	251	255	258

NO HOLDING TIME LESS THAN 30 SECONDS

		LENGTH OF MAIN LINE IN FEET (m)														
		12" (305 mm) DIAMETER														
		25	50	75	100	125	150	175	200	225	250	275	300	400	500	
		7.6	15.2	22.9	30.5	38.1	45.7	53.3	61	68.6	76.2	83.8	91.4	121.9	152.4	
LENGTH OF LATERAL IN FEET (m) 4" (101.6 mm) DIAMETER	25	7.6	44	84	123	163	202	242	282	321	332	333	334	334	336	336
	50	15.2	48	88	128	167	207	246	286	323	324	326	327	328	331	333
	75	22.9	53	92	132	172	211	251	290	316	317	319	321	323	327	329
	100	30.5	57	97	136	176	216	255	295	308	311	313	316	317	323	326
	125	38.1	62	101	141	180	220	260	297	301	304	308	310	312	319	323
	150	45.7	66	106	145	185	224	264	290	295	299	302	305	308	315	319
	175	53.3	70	110	150	189	229	268	283	289	293	297	300	303	311	316
	200	61	75	114	154	194	233	271	277	283	288	292	296	299	308	313
	225	68.6	79	119	158	198	238	265	272	278	283	288	291	295	304	310
	250	76.2	84	123	163	202	242	259	267	273	278	283	287	291	301	308
	275	83.8	88	128	167	207	244	254	262	269	274	279	283	287	298	305
	300	91.4	92	132	172	211	239	249	257	264	270	275	279	283	295	302
	350	106.7	101	141	180	218	231	241	249	256	262	268	272	276	289	297
	400	121.9	110	150	189	210	223	233	242	249	255	261	266	270	283	292
	450	137.2	119	158	189	204	216	227	235	243	249	255	260	264	278	288
	500	152.4	128	166	184	198	210	221	229	237	243	249	254	259	273	283

NO HOLDING TIME LESS THAN 30 SECONDS

		LENGTH OF MAIN LINE IN FEET (m)														
		12" (305 mm) DIAMETER														
		25	50	75	100	125	150	175	200	225	250	275	300	400	500	
		7.6	15.2	22.9	30.5	38.1	45.7	53.3	61	68.6	76.2	83.8	91.4	121.9	152.4	
LENGTH OF LATERAL IN FEET (m) 6" (154.4 mm) DIAMETER	25	7.6	50	89	129	168	208	248	287	327	331	332	333	333	335	336
	50	15.2	59	99	139	178	218	257	297	321	323	325	326	327	330	332
	75	22.9	69	109	149	188	228	267	307	314	316	318	320	321	326	328
	100	30.5	79	119	158	198	238	277	302	306	309	312	314	316	321	325
	125	38.1	89	129	168	208	248	287	295	300	303	306	309	311	317	321
	150	45.7	99	139	178	218	257	284	289	294	298	301	304	306	314	318
	175	53.3	109	149	188	228	267	278	284	289	293	296	299	302	310	315
	200	61	119	158	198	238	265	272	278	284	288	292	295	298	306	312
	225	68.6	129	168	208	248	260	268	274	279	284	288	291	294	303	309
	250	76.2	139	178	218	246	255	263	269	275	280	284	287	290	300	306
	275	83.8	149	188	228	242	251	259	266	271	276	280	284	287	297	304
	300	91.4	158	198	227	238	248	255	262	268	272	277	281	284	294	301
	350	106.7	178	208	221	232	241	249	255	261	266	271	274	278	289	296
	400	121.9	189	204	217	227	236	243	250	256	261	265	269	273	284	292
	450	137.2	187	201	213	223	231	239	245	251	256	260	264	268	279	288
	500	152.4	186	199	210	219	227	234	240	246	251	256	260	263	275	284

NO HOLDING TIME LESS THAN 30 SECONDS

**ADOPTED: 1976**  
**REVISED: 1982**  
**REAFFIRMED: 1984**

**Installation Standard  
For  
EXTRA-STRENGTH VITRIFIED CLAY PIPE IN BUILDING DRAINS**

**IAPMO IS 18-85**

This standard shall govern the installation of extra strength vitrified clay pipe in gravity building drains. (See Section 315.0 for allowable location.) Installation, material, and inspection shall comply with the current edition of the Uniform Plumbing Code published by the International Association of Plumbing and Mechanical Officials and this standard.

*Note: The following sections of the Uniform Plumbing Code apply to vitrified clay pipe.*

202.0	Definitions, Building Drain
Table 14-1	Extra Strength Vitrified Clay Pipe ASTM C700-91 Fittings, Couplings, Molded Rubber ASTM C425-90a
310.0	Workmanship
313.0	Protection of Piping, Materials, and Structures Direct embedment in concrete or masonry
314.0	Supporting in the Ground
315.0	Backfill
103.5	Inspections
103.5.3.2	Test
103.5.4.2	Responsibility
712.2	Water Test
712.3	Air Test
103.5.3.5	Exceptions
Chapter 7	Drainage
701.1.3	Location of piping and use in pressurized drainage systems
316.1.4	Joints
705.3.1	Use of Joints

**Chapter 2 Definitions**

Chapter 14

ASTM	American Society for Testing and Materials
IAPMO	International Association of Plumbing and Mechanical Officials
UPC	Uniform Plumbing Code published by IAPMO

**301.1**

**Minimum Standards**

**301.1.1**

**Materials.** Pipe and fittings shall be a minimum 3 inch (76 mm) in size, "Extra Strength" and couplings shall be molded rubber sewer couplings. They shall conform to the applicable standards in Table 14-1 of the UPC.

**301.1.2**

**Markings**

**301.1.2.1**

**Pipe and Fittings.** Each length of pipe and each fitting shall be marked with at least the following:

- (a) Manufacturer's name or initials;
- (b) "Extra Strength" or "ES";
- (c) Location of the plant; and
- (d) Pipe and fittings listed by IAPMO that are covered by this Standard shall be labeled with the designated IAPMO certification mark to show compliance with this standard.

**301.1.2.2**

**Couplings.** Couplings assemblies shall be marked with at least the following:

- (a) Manufacturer's name or trademark on rubber couplings and take-up band or screw take-up housing;
- (b) Size, on rubber coupling;
- (c) Year of manufacture on rubber coupling;
- (d) Grade of material on take-up band or screw take-up housing; and
- (e) Couplings and components listed by IAPMO that are covered by this Standard shall be labeled with the designated IAPMO certification mark to show compliance with this standard.

**315.0**

**Burial and Separation**

**315.1**

**Burial.** Pipe and fittings shall be buried 12 inches (305 mm) minimum.

**315.2**

**Separation.** Pipe and fittings shall not be run or laid in the same trench with water piping unless both the following conditions are met:

- (1) The bottom of the water pipe, at all points, shall be at least 12 inches (305

- mm) above the top of the drain line, and
- (2) The water pipe shall be placed on a solid shelf excavated at one side of the common trench.

**316.0      Types of Joints**

Joints shall be made with couplings or with flexible compression factory fabricated joints.

**705.0      Use of Joints**

Transitions between clay and other materials shall be made with molded rubber sewer couplings and appropriate bushings or reducers.

**ADOPTED: 1980**

**REVISED: 1982, 1985**

**Installation Standard  
for  
CPVC SOLVENT-CEMENTED HOT AND COLD WATER DISTRIBUTION SYSTEMS**

**IAPMO IS 20-2000**

This standard shall govern the installation of CPVC piping (IPS pipe and SDR-11 tubing) in potable hot and cold water distributing systems within buildings. (For allowable locations and pressure, see Sections 609.2 and 609.4.) Installation, material, and inspection shall comply with the current edition of the UPC, published by the International Association of Plumbing and Mechanical Officials, and shall also comply with this standard.

*Note: The following sections of the Uniform Plumbing Code apply to CPVC IPS piping and SDR-11 tubing.*

Table 14-1

Chlorinated Poly(Vinyl Chloride) (CPVC) Plastic Hot Water Distribution System ASTM D 2846-97
Chlorinated Poly(Vinyl Chloride) (CPVC) Plastic Pipe, Schedules 40 and 80 ASTM F 441-97
Socket Type Chlorinated Poly(Vinyl Chloride) (CPVC) Plastic Pipe Fittings Schedule 40 ASTM F 438-97
Socket Type Chlorinated Poly(Vinyl Chloride) (CPVC) Plastic Pipe Fittings Schedule 80 ASTM F 439-97a
Solvent Cements for Chlorinated Poly(Vinyl Chloride) (CPVC) Plastic Pipe and Fittings ASTM F 493-97a
301.1 Minimum Standards
310.0 Workmanship
311.0 Prohibited Fittings and Practices
313.0 Protection of Piping, Materials and Structures
314.0 Hangers and Supports
103.5 Inspections
316.2.3 Connection to other materials

Chapter 6	Water Distribution
<b>Chapter 2* Definitions</b>	
202.0	CPVC Chlorinated Poly(Vinyl Chloride)
Pipe or tubing	"Pipe" or "piping" includes both pipe and piping, unless specified as "IPS Pipe" or "tubing."
Chapter 14	
ASTM	American Society for Testing and Materials
IAPMO	International Association of Plumbing and Mechanical Officials
NSF	National Sanitation Foundation
UPC	Uniform Plumbing Code published by IAPMO

\*The first three numbers refer to the corresponding section of the UPC.

**301.1 Minimum Standards**  
**301.1.1 Materials.** Materials shall comply with the following:

<b>Materials</b>	<b>ASTM Standard</b>
Raw Material-CPVC 23447-B	D 1784-97
IPS Pipe	
Sch. 40 (1/2 in., 3/4 in., and 1 in.)	F 441-97 (12.7 mm, 19.1 mm, and 25.4 mm)
Sch. 80 (1/2 in. – 2 in.)	F 441-97 (12.7 mm – 51 mm)
Tubing	
SDR 11 (1/2 in. thru 2 in.)	D 2846-97 (12.7 mm – 51mm)
Fittings	
Sch. 40 (1/2 in., 3/4 in. and 1 in.)	F 438-97 (12.7 mm, 19.1 mm, and 25.4 mm)
Sch. 80 (1/2 in. – 2 in.)	F 439-97 (12.7 mm – 51mm)
Tube Fittings (1/2 in. – 2 in.)	D 2846-97 (12.7 mm – 51 mm)
<b>Primer.</b> Listed primers shall be used that	



are compatible with the type of listed CPVC cement and pipe used. The primer shall be a true solvent for CPVC, containing no slow drying ingredient. Cleaners shall not be allowed to be used as a substitute or equivalent for a listed primer.

*Note: Manufacturer shall provide test data from an independent testing laboratory acceptable to the Administrative Authority that their CPVC pipe, together with recommended fittings, has a short term working pressure (STWP) and temperature rating of 150 psi (1030 kPa) at 210°F (99°C) for 48 hours or more.*

**301.1.1.1 Material.** Pipe and fittings are plastic and are usually light gray for IPS pipe and fittings, and tan for SDR 11 tubing and fittings.

**301.1.2 Markings**

**301.1.2.1 Pipe and Tubing.** IPS pipe and tubing shall be legibly marked at intervals of not more than 5 feet (1524 mm) with at least the following:

- (a) Manufacturer's name or trademark;
- (b) ASTM F441 (Sch. 40 and 80 pipe) or ASTM D2846 (SDR 11 tubing);
- (c) Size;
- (d) CPVC 4120;
- (e) Schedule 40 or 80 (IPS pipe) or SDR 11 (tubing);
- (f) Pressure ratings at 73°F (23°C) (IPS pipe) or 100 psi (689 kpa) at 180°F (82°C) (SDR 11 tubing);
- (g) NSF seal or marking or other acceptable agency showing compliance to NSF 14;
- (h) Manufacturer's production code marking; and
- (i) Pipe and tubing listed by IAPMO that is covered by this standard shall be labeled with the designated IAPMO certification mark to show - compliance with this standard.

**301.1.2.2 Fittings.** Fittings shall be marked with at least the following:

- (a) Manufacturer's name or trademark;
- (b) ASTM F 438 (Sch. 40), ASTM F 439 (Sch. 80), or ASTM D 2846 (tubing);

- (c) CPVC;
- (d) NSF seal or marking of other acceptable agency showing compliance to NSF 14; and
- (e) Fittings listed by IAPMO that are covered by this standard shall be labeled with the designated IAPMO certification mark to show compliance with this standard.

*Note: Standard number may be omitted on smaller fittings when marked thus with four raised dots.*

**301.1.2.3 Solvent Cement**

**301.1.2.3.1 Markings.** Container labeling of CPVC solvent cement shall include at least the following:

- (a) Manufacturer's name or seller's name and address and tradename or trademark, or both;
- (b) ASTM F 493;
- (c) Cement for CPVC Pipe;
- (d) Pipe sizes, SDR, and schedules for which the cement is recommended;
- (e) Procedure or instructions for application and use;
- (f) Lot number of batch on container (not on closure or lid);
- (g) NSF seal or marking of other acceptable agency showing compliance with NSF 14;
- (h) Potable water;
- (i) All safety warnings;
- (j) A listing of those and only those solvents contained in the cement; and
- (k) Solvent cement listed by IAPMO

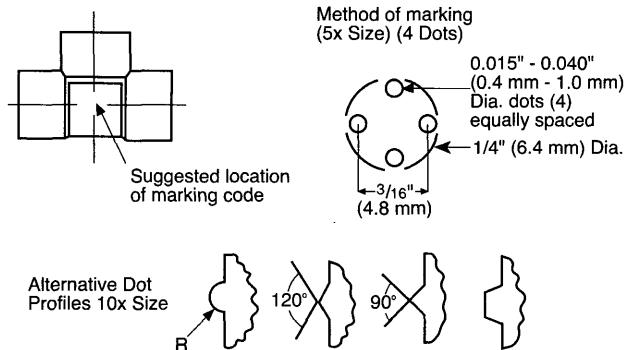

- that is covered by this standard shall be labeled with the designated IAPMO certification mark to show compliance with this standard.
- 301.1.2.3.2 Color.** Solvent cements shall be colored orange.
- 301.1.2.4 Markings**
- 301.1.2.4.1 Primer.** Primer containers shall be marked with at least the following:
- (a) Manufacturer's name or trademark;
  - (b) NSF seal or marking of other acceptable agency showing compliance to NSF 14;
  - (c) CPVC Primer;
  - (d) ASTM F 656;
  - (e) Procedures or instructions for application and use;
  - (f) A listing of those and only those solvents contained in the primer; and
  - (g) Primers listed by IAPMO that are covered by this standard shall be labeled with the designated IAPMO certification mark to show compliance with this standard.
- 301.1.2.4.2 Color.** Primer shall be colored so as to make its use obvious on a finished joint but shall not be colored orange or yellow.
- 301.1.3 Position of Markings.** Identification markings shall be visible for inspection without moving materials.
- 310.0 Alignment.** Piping and fittings shall be aligned properly without strain.
- 313.0 Protection of Materials**
- 313.1 Abrasion.** Pipe or tubing passing through drilled or notched metal studs, joists, or hollow shell masonry walls shall be protected from abrasion due to thermal expansion and contraction by elastomeric or plastic sleeves or grommets, or other approved means. Straight runs may have protection at maximum intervals of 3 feet (915 mm).
- 313.2 Puncture.** Steel plate protection shall be installed when required by the Administrative Authority.
- 313.3 Attic Opening.** Piping closer than 6 feet (1829 mm) to an attic opening shall be protected.
- 313.4 Storage and Handling.** Pipe shall be stored in a way to protect it from mechanical damage (slitting, puncturing, etc.). It shall be stored under cover to keep it clean and avoid long-term exposure to sunlight. Exposure to sunlight during normal construction periods is not harmful. CPVC solvent cements should be stored in a cool place except when actually in use on the job-site. The solvent cement manufacturer's specific storage instructions should be followed.
- 313.5 Freezing.** In areas where the system must be drained to protect it from freezing, horizontal lines shall be graded to drain.

**TABLE 313.7.2**  
**Developed Length "L" of Expansion Loops**

Nominal Size Inches (mm)	Length of Run in Feet (mm)				
	20 (6096)	40 (12,192)	60 (18,288)	80 (24,384)	100 (30,480)
	Loop Length "L" in Inches (mm)				
1/2 (12.7)	22 (6706)	31 (9449)	38 (11,582)	44 (13,411)	50 (15,240)
3/4 (19.1)	26 (7925)	37 (11,278)	46 (14,021)	52 (15,850)	58 (17,678)
1 (25.4)	30 (9144)	42 (12,802)	52 (15,850)	60 (18,288)	67 (20,422)
1-1/4 (32)	33 (10,058)	47 (14,326)	57 (17,374)	66 (39,917)	74 (22,555)
1-1/2 (38)	36 (10,973)	51 (15,545)	62 (18,898)	72 (21,946)	80 (24,384)
2 (51)	41 (12,497)	58 (17,678)	71 (21,641)	82 (24,994)	91 (27,737)

*Example:* Pipe Size – 1/2 inch (12.7 mm) Length of Run – 60 feet (18288 mm): (38") (965 mm) (from table).

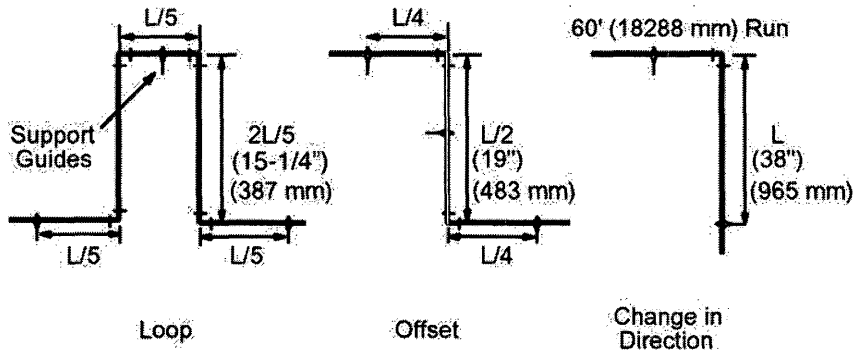

**313.6 Overheating:**

- (a) Tubing shall not be positioned closer than 6 inches (152 mm) to gas appliance vents, nor located in a confined space (such as a stud cavity) containing an appliance vent. Tubing and recessed light fixtures shall be separated by 12 inches (305 mm).
- (b) Do not apply direct flame onto CPVC.

**313.7 Thermal Expansion**

**313.7.1 General.** Allowance for thermal expansion and contraction shall be provided by approved means. Allowance shall be based on an expansion rate of 3.5 inches (100 mm) per 100 feet (30,480 mm) of length of run per 100°F (38°C) temperature change.

*Note:* Expansion rate is independent of the size of the pipe.

**313.7.2 Offsets and Loops.** Thermal expansion may be provided for by use of expansion loops, offsets, or changes of direction. From Table 313.7.2 determine the length "L" that is required. Note that "L" is based on length of run, diameter of pipe, and maximum temperature of water.

**313.8 Clearance.** Adequate clearance shall be provided between piping and structure (such as bored holes and sleeves) to allow for free longitudinal movement.

**314.0 Hangers and Supports**

**314.1 Vertical Piping.** Vertical piping shall be supported at each floor or as

**314.2 Horizontal Piping.** Unless an engineered design is provided and approved by the Administrative Authority, the following provisions shall apply. Horizontal piping 1 inch (25.4 mm) or smaller shall be supported at maximum 3 foot (914 mm) intervals. Piping 1-1/4 inch (32 mm) or larger shall be supported at maximum 4 foot (1219 mm) intervals.

**314.3 Hangers and Anchors.** Piping shall not be anchored rigidly to a support but rather secured with smooth hangers or straps that provide for a degree of movement and that prevent damage to the pipe. Hangers or straps with sharp or abrasive edges shall not be used. Hangers that pinch the piping shall not be used.

**316.1 Solvent Cement Joints**

**316.1.1 SAFETY REQUIREMENTS AND PRECAUTIONS<sup>1</sup>**

- (a) General. Solvents contained in PVC plastic pipe cements are classified as airborne contaminants and flammable and combustible liquids. Precautions listed in this appendix should be followed to avoid injury to personnel and the hazard of fire.
- (b) Prolonged breathing of solvent vapors should be avoided. When pipe and fittings are being

<sup>1</sup> Appendix X1. Safety Requirements And Precautions, from ASTM D 2564-88 Solvent Cements for Poly(Vinyl Chloride) (PVC) Plastic Pipe and Fittings is reprinted with permission from the American Society for Testing and Materials, 1916 Race St., Philadelphia, PA 19103, copyright.

joined in partially enclosed areas, a ventilating device should be used in such a manner as to minimize the entry of vapors into the breathing areas.

- (c) Solvent cements should be kept away from all sources of ignition, heat, sparks, and open flame.
- (d) Containers for solvent cements should be kept tightly closed except when the cement is being used.
- (e) All rags and other materials used for mopping up spills should be kept in a safety waste receptacle, which should be emptied daily.
- (f) Most of the solvents used in PVC pipe cements can be considered eye irritants, and contact with the eye should be avoided for it may cause eye injury. Proper eye protection and the use of chemical goggles or face shields is advisable where the possibility of splashing exists in handling solvent cements. In case of eye contact, flush with plenty of water for 15 minutes and call a physician immediately.
- (g) Repeated contact with the skin should be avoided. Proper gloves impervious to and unaffected by the solvents should be worn when frequent contact with the skin is likely. Application of the solvents or solvent cements with rags and bare hands is not recommended. Brushes and other suitable applicators can be used effectively for applying the solvent cement, thus avoiding skin contact. In the event of excessive contact, remove contaminated clothing and wash-skin with soap and water.

**316.1.1.1 Selection.** Follow the manufacturer's recommendations for type of solvent cements for such conditions as temperatures over 100°F (38°C) or humidity over 60 percent.

**316.1.1.2 Handling (to maintain effectiveness).** Package solvent cement in containers no larger than 1 quart (1 liter). Keep solvent cement can closed and in the shade when not in use. Keep applicator submerged in solvent cement between applications. Discard solvent

cement when it thickens appreciably or gels. Solvent cement shall not be thinned.

**316.1.1.3 Primer.** A listed primer in compliance with ASTM F 656-96a shall be used on all CPVC solvent-cemented joints.

**316.1.1.4 Size of Applicator.** Applicator should be about one-half the pipe diameter. Do not use small applicators on large pipes.

**316.1.2 Procedures**

Step 1 Cut pipe square with hand saw and mitre box, mechanical cutoff saw, or tube cutter designed for plastic.

Step 2 Ream and chamfer pipe to eliminate sharp edges, beads, and all burrs.

Step 3 Clean all dirt, moisture, and grease from pipe and fitting socket. Use a clean, dry rag.

Step 4 Check dry fit of pipe in fittings. Pipe should enter fitting socket 1/4 to 3/4 of socket depth. On larger sizes of Sch. 80 fittings, a looser fit may be expected. This is a normal condition, and is required care to apply an adequate amount of cement.

Step 5 Apply CPVC primer (see Section 316.1.1.1) to inside of fitting socket. Take care to avoid puddling.

Step 6 Apply CPVC primer to outside surface of pipe to depth of fitting socket.

Step 7 Wait until primer surface is tacky. DO NOT attempt to soften (dissolve) the surface as is required for PVC.

Step 8 Apply a liberal coat of CPVC solvent cement to the outside surface of the pipe to the depth of the fitting socket.

Step 9 Apply a light coat of CPVC solvent cement to inside of fitting socket. Apply a second liberal coat of cement to the pipe end. Take particular care in cementing larger sizes of Sch. 80 fittings. Be sure all surfaces are coated.

Step 10 While both the inside socket

**TABLE 316.1.2**

Joint Cure Schedule					
Temperature Range of Pipe and Fittings during assembly and cure		Minimum Joint Set Time, hrs. (Step 12)	Minimum Cure Time before testing, hrs. (Step 14)		Minimum Time before putting system into service at 80 psi/160°F (71°C), hrs.
			Pipe Size		
			1/2 - 1 in. (12.7-25.4 mm)	1-1/4 - 2 in. (32-51 mm)	
°F	°C				
60-100	16-38	1/2	1	2	24
40-60	4-16	1	2	4	48

surface and the outside surface of the pipe are WET with solvent cement, forcefully bottom the pipe in the socket, giving the pipe a quarter turn while inserting, if possible.

Step 11 Hold the joint together for 10 to 15 seconds to assure that the pipe remains bottomed against the pipe stop.

Step 12 Do not disturb the joint for at least 30 minutes.

Note: The joint is weak until the cement is dry. If the joint is adjusted after it is set, the joint will be ruined. See Table 316.1.2 for recommended set time.

Step 13 Wipe excess cement from the pipe. A properly made joint will show a bead of cement around its entire perimeter. Any gaps may indicate insufficient cement.

Step 14 The system shall not be pressurized until the joints have cured (set) at least as long as recommended by the manufacturer. If the manufacturer's recommendation is not available, the following cure times are required.

**316.1.3 Prohibited Joints.** Piping shall not be threaded. Female screwed fittings, with CPVC threads, shall be prohibited. Joints made with adhesives shall be prohibited.

**316.1.4 Threaded Joints.** When threads are required, molded male adapters shall be used.

**316.1.4.1 Location.** CPVC threaded joints shall be accessible.

**316.1.4.2 Lubricants.** Only thread tape or thread lubricant approved specifically for use

with CPVC shall be used. Conventional pipe thread compounds, putty, linseed oil based products, and unknown mixtures are prohibited.

**316.1.4.3 Tightening.** Joints shall be tightened approximately 1-1/2 turns past handtight.

*CAUTION: Handtight refers to the number of threads to reach hand tight with metal pipe. Small sizes of CPVC can be bottomed by hand pressure alone. DO NOT overtighten.*

**316.2 Special Joints**

**316.2.1 Transition Joints.** Transitions from CPVC tubing to metal piping and valves shall be made only with listed transition fittings suitable for that purpose. When required, the transition fittings shall be designed in such a manner that it can be anchored to a building member to prevent rotation.

**316.2.2 Soldering.** Soldered metal joints shall not be made closer than 18 inches (457 mm) to any already installed plastic-to-metal adapter in the same water line.

**316.2.3 Hose Bibbs.** Hose bibbs shall be connected only to metal system components which are adequately anchored to the building structure. The CPVC plastic system shall terminate in wall.

**608.0 Water Hammer Arresters and Pressure Relief Valves**

**608.1 CPVC Piping.** CPVC piping used for temperature and/or pressure relief valve drain lines shall be graded to the



shall be bled off. The system shall be pressure tested under a water pressure which is not less than the working pressure under which it is to be used for a minimum of two (2) hours. All leaks shall be corrected. Foam pipe insulation or other approved material shall be installed on all stubups to prevent damage during concrete pour and finishing.

**609.5 Identification.** A permanent sign with the legible words "This building has non-metallic interior water piping" shall be fastened on or inside the main electric service panel.

**609.6 Position of Marking.** When installed, piping and fittings shall be positioned so that, when practical, identifying

markings shall be readily visible for inspection.

**609.7**

**Testing.** Air testing is prohibited.

**610.0**

**Sizing**

**610.1**

**Method.** Piping shall be sized in accordance with UPC Section 610.0. When Appendix A is applicable, use Chart 610.1.1, 610.1.2, or 610.1.3 as appropriate. Flow velocities shall be limited to a maximum of 8 feet per second (2.4 mp/s). See Table 610.1.

**ADOPTED: 1982**

**REVISED: 1984, 1985, 1989, 1990, 1991, 1992, 1993, 1995, 1996, 1998, 2000**

**CHART 610.1.1**

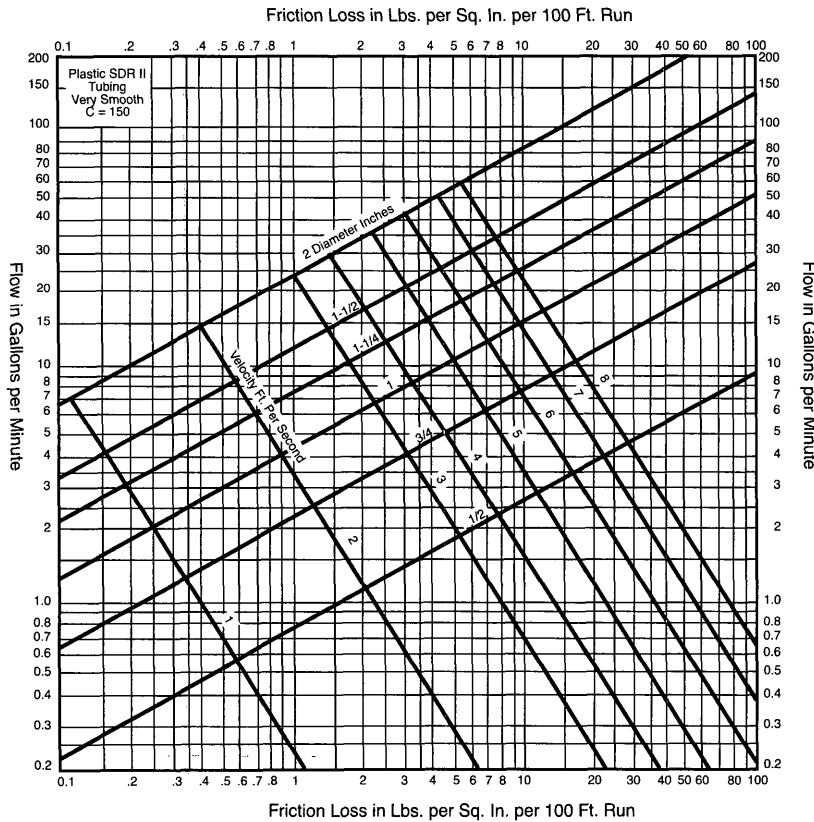
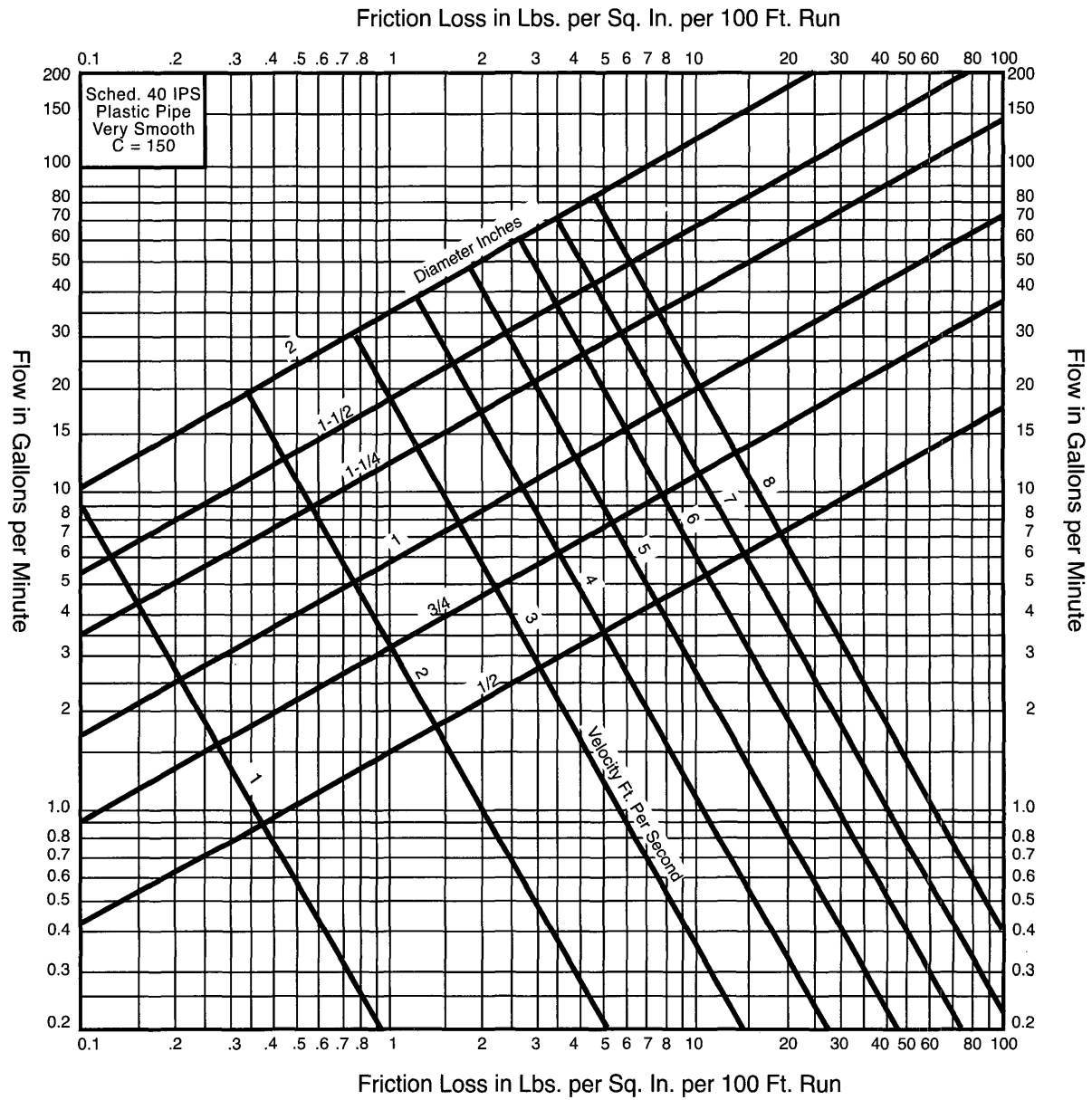
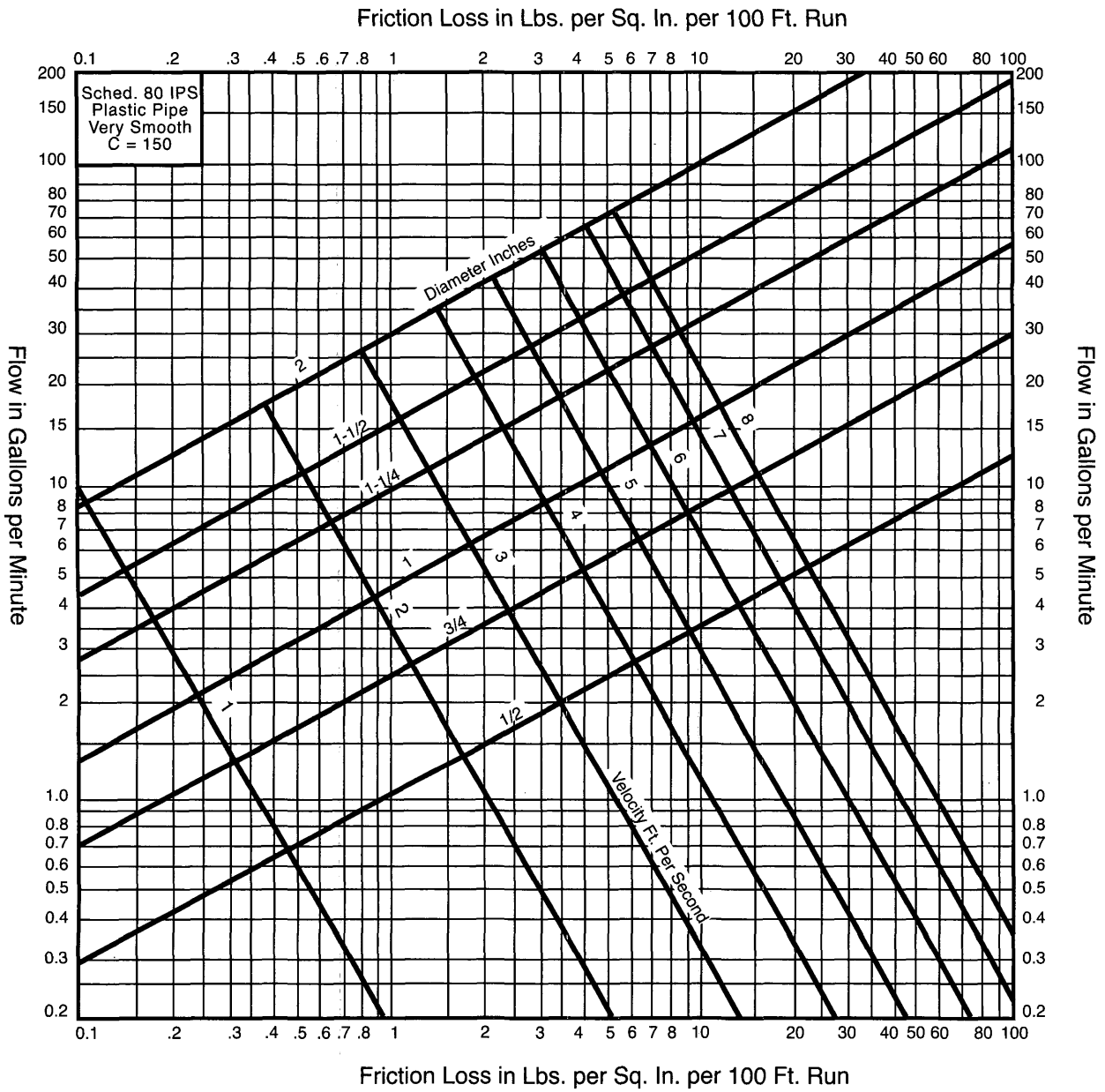

CHART 610.1.2





### CHART 610.1.3



**Installation Standard  
For  
WELDED COPPER AND COPPER ALLOY WATER TUBE**

**IAPMO IS 21-89**

This standard shall govern the installation of welded copper and copper alloy water tube in potable hot and cold water systems. Installation, material, and inspection shall comply with this standard and the current edition of the UPC published by the International Association of Plumbing and Mechanical Officials.

*Note: The following sections of the Uniform Plumbing Code apply to welded copper and copper alloy water tube.*

Table 14-1 Standards

ANSI B 16.18-84	Cast Copper Alloy Solder-Joint Pressure Fittings
ANSI B 16.22-95	Wrought Copper and Copper Alloy Solder Joint Pressure Fittings
ASTM B 447-93	Standard Specification for Welded Copper Tube
ASTM B 642-88 <sup>et</sup>	Welded Copper Alloy UNS No. C21000 Water Tube

606.2.1	Use of Joints, Copper Water Tube
316.2	Special Joints
316.2.1	Copper Tubing to Screw Pipe Joints
705.3.3	Ground Joint, Flared or Ferrule Connections
317.0	Increases and Reducers Chapter 6 Water Distribution
604.0	Materials
604.1	Materials, Water Pipe and Fittings
604.7	Restriction of Used Piping
608.0	Relief Valve Drains
609.0	Installation, Inspection, and Testing
610.0	Size of Portable Water Piping Appendix A Chart A-4 Friction Loss

**301.1 Minimum Standards**

301.1	Minimum Standards
903.2	Use of Copper Tubing
811.1	Chemical or Industrial Waste
604.2	Water Piping
604.3	Marking of Tubing
604.4	Flexible Water Connectors
310.0	Workmanship
311.0	Prohibited Fittings and Practices
313.0	Protection of Piping, Materials, and Structures
314.0	Hangers and Supports Vertical Plumbing
314.0	Hangers and Supports Horizontal Plumbing
314.0	Hangers and Anchors
103.5.3	Test
316.1	Types of Joints
316.1.2	Wiped Joints
316.1.3	Solder and Sweat Joints
606.1.1	Flared Joints

**301.1.1**

**Materials.** Materials shall comply with the appropriate standard in Table 14-1 of the UPC.

*Note: The nominal or standard size of copper and copper alloy welded water tube is always 0.125 inch (3.8 mm) or 1/8 inch (3.8 mm) smaller than the actual outside diameter dimension of the tube. For example, 3 inch (76 mm) nominal size copper plumbing tube measures 3-1/8 inch (79.2 mm) O.D.; 1/2 inch (12.7 mm) nominal size copper plumbing tube measures 5/8 inch (15.9 mm) O.D., etc.*

**903.2**

**Use of Copper Tubing**

**903.2.1**

**Markings.** Markings shall be visible for inspection.

**903.2.1.1**

Water tube shall bear the following incised marked at not over 18 inch (457 mm) intervals:

- (a) Manufacturer's name or trademark;
- (b) Tube type; and

(c) Country of origin.

**903.2.1.2** Hard-drawn tube shall be identified throughout its entire length by a colored marking not less than 3/16 inch in height, including legend repeated at intervals not greater than 3 feet (914 mm). The legend shall include the type of tube, welded, ASTM specification, name or trademark of the manufacturer or both, and the country of origin.

(a) Tube listed by IAPMO that is covered by this standard shall be labeled with the designated IAPMO certification mark to show compliance with this standard.

**316.1 Joints**

**316.1.1 General Information.** Copper tube and fittings may be joined in a number of ways, depending on the purpose of the system. Soldering and brazing with capillary fittings are the methods used most. The American Welding Society defines soldering as a joining process which takes place below 840°F (449°C) and brazing as a similar process which occurs above 840°F (449°C) but below the melting point of the base metals. In actual practice for copper systems, most soldering is done at temperatures ranging from about 350°F to 550°F (177°C to 288°C), while most brazing is done at temperatures ranging from 1100°F to 1500°F (593°C to 816°C). The choice between soldering or brazing will generally depend on operating

conditions.  
used

Solder joints are generally  
where

the service temperature does not exceed 205°F (96°C), while brazed joints can be used where greater strength is required or where system temperatures are as high as 400°F (204°C).

**316.1.1.1 Fittings for Soldered, Brazed, and Flared Joints.**

Fittings are available in all standard tube sizes and in a wide variety of types to cover needs for plumbing. They can be either soldered or brazed, although brazing cast fittings requires care. Wrought copper pressure fittings are also available over a wide range of sizes and types. These, too, can be joined by

either soldering or brazing, and wrought fittings are preferred where brazing is the joining method. Otherwise, the choice between cast and wrought fittings is largely a matter of the user's preference. Flared-tube fittings provide metal-to-metal contact similar to ground joint unions; both can be easily taken apart and reassembled. They are especially useful where residual water cannot be removed from the tube and soldering is difficult. Flared joints may be required where a fire hazard exists and the use of a torch to make soldered or brazed joints is not allowed.

**316.1.1.2 Solders**

*Note: Users of the Uniform Plumbing Code are reminded that provisions of the Federal Clean Drinking Water Act of 1986, which all must obey, forbid the use of solder which contains in excess 0.2% of lead, by weight in potable water systems. The provisions of the act are incorporated in all ordinances, statutes, state and municipal regulations by reference and by operation of law.*

The selection of a solder depends on the operating pressure and temperature of the line. Consideration should also be given to the stresses on the joint caused by thermal expansion and contraction. However, stresses due to temperature changes should not be significant in two commonly encountered cases: when tube lengths are short, or when expansion loops are used in long tube runs.

Solder is generally used in wire form, but paste-type solders are also available. These are finely granulated solders in suspension in a paste flux. When using paste-type solders, observe these four rules:

1. Wire solder must be applied in addition to the paste to fill the voids and assist in displacing the flux; otherwise the surfaces may be well "tinned" and yet there may not be a good joint with a continuous bond.
2. The paste mixture must be thoroughly stirred if it has been standing in the can for more than a very short time, as the solder has a tendency to settle rapidly to the bottom.

3. The flux cannot be depended on to clean the tube. Cleaning should be done manually, as is recommended for any other flux and solder.
4. Any excess flux must be removed. Solders are available containing small amounts of silver or other additives to impart special properties. Such solders may require special fluxes. The manufacturer's recommendations should be consulted regarding proper procedures and fluxes for such solders and about the expected properties.

### 316.1.1.3 Soldering Flux

The functions of the soldering flux are to remove residual traces of oxides, to promote wetting, and to protect the surfaces to be soldered from oxidation during heating. The flux should be applied to clean surfaces, and only enough should be used to lightly coat the areas to be joined.

An oxide film may reform quickly on copper after it has been cleaned.

Therefore, the flux should be applied as soon as possible after cleaning.

#### CAUTION:

Careless workmanship, especially during flux applications, can result in corrosion of the tube long after the system has been installed. If excessive flux is used, the residue inside the tube can cause corrosion. In an extreme case, such residual flux can actually lead to perforation through the tube wall causing leakage. To guard against this danger, it is important to (1) choose a flux that is not too corrosive and (2) use only the minimum amount actually needed to make the joint.

### 316.1.2 Solder Joints

Soldering and brazing both involve basic steps, which must be executed with care and craftsmanship. The steps are:

- (1) Measuring
- (2) Cutting
- (3) Reaming
- (4) Cleaning
- (5) Fluxing

- (6) Assembly and support
- (7) Heating
- (8) Applying the filler metal
- (9) Cooling and cleaning

Each step contributes to a strong, dependable joint.

#### 316.1.2.1 Measuring

The length of each tube segment must be accurate. Inaccuracy can compromise joint quality. If the tube is too short it will not reach all the way into the socket of the fitting and a proper joint cannot be made. If the tube segment is too long, there is danger of cocking the tube in the fitting and putting strain on the system which could affect service life.

#### 316.1.2.2 Cutting

Once the tube is measured it can be cut. Cutting can be accomplished in a number of different ways to produce a satisfactory square end. The tube can be cut with a disc-type tube cutter, a hacksaw, an abrasive wheel, or with a stationary or portable bandsaw.

Care must be taken that the tube is not deformed while being cut. Regardless of method, the cut must be square with the run of the tube so that the tube will seat properly in the fitting socket.

#### 316.1.2.3 Reaming

All pipe and tube shall be reamed to the full ID of the pipe and tube. Tools used to ream tube ends include the reaming blade on the tube cutter, half-round or round files, a pocket knife, and a suitable deburring tool. With annealed tube, care must be taken not to deform the tube end by applying too much pressure. Both the inside and the outside of the tube may require removal of the burr.

#### 316.1.2.4 Cleaning

The removal of oxides and surface soil is crucial if filler metal is to flow properly into the joint. Unremoved oxide, surface soil, and oil can interfere with the strength of the joint and cause failure. Mechanical cleaning is a simple operation. The end of the tube should be abraded lightly using sand cloth or nylon abrasive pads for a distance only slightly more than the depth of the fitting socket. The socket of the fitting

should also be cleaned using sand cloth, abrasive pads, or a properly sized fitting brush.

Copper is a relatively soft metal. If too much material is removed, a loose fit will result and interfere with satisfactory capillary action in making the joint. The capillary space between the tube and fitting is approximately 0.004 inch (0.10 mm). Solder or brazing filler metal can fill this gap by capillary action. This spacing is critical for the filler metal to flow into the gap and form a strong joint.

Once cleaned, surface should not be touched with bare hands or oily gloves. Skin oils, lubricating oils, and grease impair solder flow and wetting.

#### **316.1.2.5 Fluxing**

Stir the flux before use. A good flux will dissolve and remove traces of oxide from the cleaned surfaces to be joined, protect the cleaned surfaces from reoxidation during heating, and promote wetting of the surfaces by the solder. A thin, even coating of flux should be applied with a brush to both tube and fitting. Do not apply with fingers. Chemicals in the flux can be harmful if carried to the eyes or open cuts.

#### **316.1.2.6 Assembly and Support**

After both tube and fitting surfaces are properly fluxed, they should be assembled, making sure the tube seats against the base of the fitting socket. A slight twisting motion ensures even distribution by the flux. Remove excess flux. Care must be taken to ensure that the tube and fittings are properly supported with a uniform capillary space around the entire circumference of the joint. Uniformity of capillary space will ensure good filler metal penetration if the guidelines of successful joint-making are followed. Excessive joint clearance can cause the filler metal to crack under stress or vibration.

The joint is now ready for soldering. Joints prepared and ready for soldering should be completed the same day and not left unfinished overnight.

#### **316.1.2.7 Heating**

Because an open flame may be used for soldering and because flammable gases

are used, safety precautions must be observed. The heat is generally applied using an air/fuel torch. Such torches use acetylene or an LP gas. Electric resistance tools can also be used.

Heating should begin with the flame perpendicular to the tube. The copper tube conducts the initial heat into the fitting socket for even distribution of heat inside and out. The extent of this preheating depends upon the size of the joint. Experience will indicate the amount of time needed. The flame should now be moved onto the fitting. Then move the flame from the fitting socket back onto the tube a distance equal to the depth of the fitting socket. Touch the solder to the joint. If the solder does not melt, remove it and continue the heating process. Be careful not to overheat or to direct the flame into the fitting cup. This could cause the flux to burn and destroy its effectiveness. When the melting temperature of the solder has been reached, heat may be applied to the base of the cup to aid capillary action in drawing the solder into the cup.

#### **316.1.2.8 Applying the Filler Metal**

For tube in a horizontal position, start applying the solder slightly off-center at the bottom of the joint. Proceed across the bottom of the fitting and up to the top center position. Return to the point of beginning, overlap the starting point, and then proceed up the uncompleted side to the top again, overlapping the solder.

For joints in the vertical position, a similar sequence of overlapping passes should be made, starting wherever is convenient. Molten solder will be drawn into the joint by capillary action regardless of whether the solder is being fed upward, downward, or horizontally.

#### **316.1.2.9 Cooling and Cleaning**

After the joint has been completed, natural cooling is best. Shock cooling with water may cause unnecessary stress on the joint and result in eventual failure. When cool, clean off any remaining flux with a wet rag.

#### **316.1.3 Brazed Joints**

Brazing is the second most commonly used method for joining copper tube. Making brazed joints is similar to making soldered joints with respect to measuring, cutting, reaming, cleaning, assembly and support. And as in soldering, the brazing filler metal is melted by the heat of the tube and fitting and drawn into the joint by capillary action.

The major differences between soldering and brazing are the:

- Type of flux used,
- Composition of filler metal, and
- Amount of heat required to melt the filler metal.

#### 316.1.3.1 Brazing Flux

The fluxes used for brazing copper joints are different in composition from soldering fluxes. The two types cannot be used interchangeably. Brazing fluxes are water based, whereas most soldering fluxes are petroleum based. Similar to soldering fluxes, brazing fluxes dissolve and remove residual oxide from the metal surface, protect the metal from reoxidation during heating, and promote wetting of the surfaces to be joined by the brazing filler metal.

Fluxes also provide the draftsman with an indication of temperature. Application of the flux is the same as when soldering. If the outside of the fitting and the heat-affected area of the tube are covered with flux (in addition to the end of the tube and the cup), oxidation will be prevented, and the appearance of the joint will be greatly improved.

#### 316.1.3.2 Brazing Filler Metals

There are two general types of brazing filler metal used for joining copper tube. Classified according to their components, they are BCuP (Brazing-Copper-Phosphorous) and BAg (Brazing-Silver).

BCuP filler metals are preferred for joining copper tube and fittings. The phosphorous in them acts as a fluxing agent, and the lower percentage of silver makes them relatively low cost. When using copper tube, wrought copper fittings, and BCuP brazing filler metal, fluxing is optional. However, when cast fittings are brazed, flux must be used.

#### 316.1.3.3 Heating

Oxy/fuel torches are generally used for brazing because of the higher temperature required. Recent innovations in tip design make air/fuel torches useful on a wider range of sizes for brazing. When working at brazing temperatures, safety precautions must be followed and care taken to protect both the operator and the materials being used. The heating operation is the same as for soldering. First preheat the tube and then the tube and fitting. When the filler metal starts to melt, apply heat at the base of the fitting socket to help draw the brazing filler metal in by capillary action.

#### 316.1.3.4 Applying Brazing Filler Metal

Remember to allow the heat of the joint, not the flame, to melt the filler metal. The melted filler metal will be drawn into the joint by capillary action.

It is very important that the flame be in continuous motion. It must not be allowed to remain on any one point long enough to burn through the tube or fitting.

If the filler metal fails to flow or has the tendency to ball up, it indicates either that there is oxide on the surfaces being joined or that the parts to be joined are not hot enough. If the filler metal refuses to enter the joint, the fitting cup is not hot enough. If it tends to flow over the outside of either part of the joint it indicates that part is overheated. When the joint is completed, a continuous fillet should be visible completely around the joint. Large diameter tube is more difficult to heat to the desired temperature. The use of a heating tip or rosebud may be necessary to maintain the proper temperature over the area being brazed. Once total heat control is attained, follow the same procedures used for smaller tube.

#### 316.1.3.5 Cooling and Cleaning

When the brazed joint is finished, allow it to cool naturally. Flux residues and some oxides formed by heating can be removed by washing with hot water and brushing with a stainless steel wire brush.

#### 606.0 Flared Joints

##### 606.1 Flared Joints with Impact Flaring Tools:

Step 1 Cut the tube to the required length.

- Step 2 Remove all burrs. This is very important to assure metal-to-metal contact.
- Step 3 Slip the coupling nut over the end of the tube.
- Step 4 Insert flaring tool into the tube end.
- Step 5 Drive the flaring tool by hammer strokes, expanding the end of the tube to the desired flare. This requires a few moderately light strokes.
- Step 6 Assemble the joint by placing the fitting squarely against the flare. Engage the coupling nut with the fitting threads. Tighten with two wrenches, one on the nut and one on the fitting.

### 606.2 Flared Joints with Screw-Type Flaring

#### Tools:

- Steps 1-3 Same as for impact flaring previously described.
- Step 4 Clamp the tube in the flaring block so that the end of the tube is slightly above the face of the block.
- Step 5 Place the yoke of the flaring tool on the block so that the beveled end of the compressor cone is over the tube end.
- Step 6 Turn the compressor screw down firmly, forming the flare between the chamber in the flaring block and the beveled compressor cone.
- Step 7 Remove the flaring tool. The joint can now be assembled as in Step 6 for impact flaring.

### 610.0 Sizing

#### 610.1 Velocity

*Note: There are various hydraulic formulas for the flow of water in pipe. With high velocity and attendant turbulent flow, there can be excessive noise and piping wear.*

The designer should aim for maximum flow velocities in the range of 5 to 8 feet per second (1.5 – 2.4 meters per second) to minimize noise and erosion problems. For the smallest tube sizes, the designer is wise to work at the bottom of this range, as a maximum, to guard against local high velocities building up due to faulty

workmanship (e.g., burrs at tube ends which are not properly reamed) or unusually numerous changes in flow direction.

### GENERAL INFORMATION

It is not possible to cover all the variables of a plumbing system; however, the following information may prove helpful

**Expansion Loops** – Copper tube, like all piping materials, expands and contracts with temperature changes. Therefore, in a copper tube system subjected to excessive temperature changes, the line tends to buckle or bend when it expands unless compensation is built into the system. Severe stresses on the joints may also occur. Such stresses, buckles, or bends are prevented by the use of expansion joints or by installing offsets, "U" bends, coil loops, or similar arrangements in the tube assembly. These specially shaped tube segments take up expansion and contraction without excessive stress. The expansion of a length of copper tube may be calculated from the formula:

$$\frac{\text{Temperature Rise } (^{\circ}\text{F}) \times \text{Length (feet)} \times 12 \text{ (inches per foot)}}{12 \text{ (inches per foot)}} \times \text{Expansion Coefficient (inch per inch per } ^{\circ}\text{F)} = \text{Expansion (inches), or}$$

$$\frac{\text{Temperature Rise } (^{\circ}\text{C}) \times \text{Length (meter)} \times 1000 \text{ (mm per meter)}}{1000 \text{ (mm per meter)}} \times \text{Expansion Coefficient (mm per mm per } ^{\circ}\text{C)} = \text{Expansion (mm)}$$

Calculations for expansion and contraction should be based on the average coefficient of expansion of copper, which is 0.0000094 per degree F (1.692 x 10<sup>-5</sup> per degree C), between 70°F and 212°F (21°C and 100°C). For example, the expansion of each 100 feet (30.5 meters) of length of any size tube heated from room temperature (70°F) to 170°F [a 100°F (55.6°C) rise] is 1.128 inches (28.7 mm).

$$\frac{100^{\circ}\text{F} \times 100 \text{ feet} \times 12 \text{ inch/foot} \times 0.0000094}{12 \text{ inch/inch/}^{\circ}\text{F}} = 1.128 \text{ inch, or}$$

$$\frac{55.6^{\circ}\text{C} \times 30.48 \text{ mm} \times 1000 \text{ mm/m} \times 1.692 \times 10^{-5}}{1000 \text{ mm/mm/}^{\circ}\text{C}} = 28.7 \text{ mm}$$

#### Tube Supports

**Vertical Piping** – See Section 314.0

**Horizontal Piping** – See Section 314.0

**Bending** – Copper tube, properly bent, will not collapse on the outside of the bend and will not buckle on the inside of the bend. Tests demonstrate that the bursting strength of a bent copper tube can be greater than it was before bending. Because copper is readily formed, expansion loops and other bends necessary in an assembly are quickly and simply made if the proper method and equipment are used. Simple hand tools employing mandrels, dies, forms, and fillers, or power-operated bending machines, are used.

bent with hand benders. The proper size bender for each size tube must be used. Usually the size of the tool corresponds to the nominal outside diameter of the tube, not the standard tube size. For a guide to the typical bend radii, see the following bending guide for copper tube.

**Adopted: 1980**

**Revised: 1989**

Both annealed tube and bending-temper tube can be

**BENDING GUIDE FOR COPPER TUBE**

Tube Size, In. (mm)	Tube Type	Temper	Minimum Bend Radius, In. (mm)	Type of Bending Equipment
1/4 (6.4)	K, L	Annealed	3/4 (19.1)	Lever type
3/8 (9.5)	K, L, M	Annealed	1-1/2 (38) 3 (76)	Lever or gear type None; by hand*
		Drawn	1-3/4 (45)	Gear Type
1/2 (12.7)	K, L, M	Annealed	2-1/4 (57) 4-1/2 (114)	Lever or gear type None; by hand*
		Drawn	2-1/2 (64)	Gear type
3/4 (19.1)	K, L	Annealed	3 (76) 4-1/2 (114)	Lever or gear type None; by hand*
			Drawn	6 (152)
	3 (76)	Gear type		
	4 (102)	Heavy-duty gear type		
	1 (25.4)	K, L	Annealed	4 (102) 7-1/2 (191)
1-1/4 (31.8)				K, L

\* When bending by hand, without the use of bending equipment, a circular wooden disc is used. The radius of the disc should be about 1/4 to 1/2 inch (6.4 to 12.7 mm) less than the minimum bend radius shown.





**Installation Standard  
For  
TRENCHLESS POLYETHYLENE (PE) PIPE FOR SEWER LATERALS**

**IAPMO IS 26-2002**

This standard shall govern the Trenchless Installation of Polyethylene (PE) pipe for use in sanitary and storm sewers. The installed pipe shall comply with the requirements of the Uniform Plumbing Code (UPC) published by the International Association of Plumbing and Mechanical Officials (IAPMO) as to grade and connections to existing pipe and shall also comply with this standard.

**ASTM  
Standard**

**Materials**

HDPE Extra-High Molecular  
Weight 3408 SDR 17 Pipe  
Socket-Type PE Fittings  
for Outside Diameter-Controlled  
Polyethylene Pipe

F 714  
  
D 2683

*Note: The following sections of the Uniform Plumbing Code apply.*

**Note:** The HDPE 3408 SDR 17 pipe used in this process was selected because of its ability to retain its circular shape even when bent on a 4 foot radius during and after installation.

- 103.5.3 Testing of Systems
- 103.5.4.2 Responsibility
- 103.5.5 Other Inspections
- 103.5.5.1 Defective Systems
- 103.6.2 Other Connections
- 202.0 Definition of PE
- 301.1 Minimum Standards
- 310.0 Workmanship
- 313.0 Protection of Piping, Materials and Structures
- 315.0 Backfilling
- 316.2.3 Connection to Other Materials
- Chapter 7 Sanitary Drainage
- 701.2 Fittings

**301.1.2 Table 14-1 Standards**

- ASTM D 1412
- ASTM D 2239
- ASTM D 2683
- ASTM D 2447
- ASTM D 2657
- ASTM D 3261
- ASTM F 714
- ASTM F 894
- IAPMO PS 25

**ABBREVIATIONS**

- ASTM American Society for Testing and Materials
- IAPMO International Association of Plumbing and Mechanical Officials
- UPC Uniform Plumbing Code

**313.0 Protection of Pipe**

**313.1 Storage and Handling**

Pipe shall be stored in a way to protect it from mechanical damage (slitting, puncturing, etc.). It shall be stored under cover to keep it clean and avoid long-term exposure to sunlight. Exposure to sunlight during normal construction periods is not harmful.

**301.1 Minimum Standards**

**301.1.1 Materials**

Materials shall comply with the following: the Polyethylene pipe used is covered by the ASTM standards listed later in this standard.

**705.1.0 Types of Joints**

PE joints shall be made as follows.

**705.1.6 Molded Rubber Coupling Joints**

Molded rubber coupling joints shall be installed in accordance with Appendix I and Section 705.1.6 of the UPC .

**705.1.8 Shielded Coupling Joints**

Shielded coupling joints shall be

- installed in accordance with Appendix I and Section 705.1.8 of the UPC.
- 705.1.9 Hubless Cast-Iron Pipe Joints**  
Hubless cast iron pipe joints shall be installed in accordance with Appendix I and Section 705.1.9 of the UPC.
- 301.1.1 Heat Fusion Joints**  
Heat fusion joints shall be made according to the manufacturer's procedure, installation instructions, and either ASTM D 2659 or ASTM D 3261, and shall meet the requirements of Section 701.1 of the UPC.
- 1211.0 Trenchless installation of sewers will be conducted as follows:**
- I. Preliminary Steps**  
Inspect the inside of the sewer line using a television camera and video tape recorder to ascertain the line condition. Mark the details revealed by the video inspection, including:
1. The ground surface to show the location of the lateral tie of the city wye.
  2. The line location with an arrow in the street pointing back at the lateral.
  3. The property denoting the lateral location.
  4. The locations of the proposed excavations.
- Obtain utility line identification service contact information and all applicable permits.
- II. Excavation**  
In addition to the above markings, the local utility companies will mark utilities. Considerations are soil density; clearance from obstacles, utilities, and structures; location of bends; and water service locations. Excavations and shoring shall be in accordance with jurisdictional safety requirements.
- III. Set Up**  
Fuse the proper length of polyethylene pipe in accordance with ASTM D 2657 or ASTM D 3261 and fuse the end to a small length that is attached to the

pulling head. A rod pusher cable is pushed through the damaged host pipe and attached to the pulling cable, which is then drawn through the pipe. The clevis end of the cable is attached to the pulling head. The pulling equipment is then set up according to the manufactures instructions.

#### IV. Pulling

Pull the pulling head through. Once the pull is done, complete the connection to the existing piping.

#### 707

#### Cleanouts

Cleanouts shall be installed in accordance with UPC Section 707.

#### 103.5

#### Inspections

The completed piping shall be internally inspected by television camera unless waived by the Administrative Authority.

#### 712.0

#### Testing

Completed piping shall be subjected to testing in accordance with Section 712.0 or 723.0 of the UPC.

**ADOPTED: 1999**

**REVISED: 2002**

**Installation Standard  
For  
ODOR CONTROL SYSTEMS FOR WATER CLOSETS  
IIAPMO IS 27-2001**

This standard shall govern the installation of Odor Control Systems for Water Closets. Installation, material, and inspection shall comply with the requirements of the Uniform Plumbing Code (UPC) published by the International Association of Plumbing and Mechanical Officials (IAPMO) and this standard.

**Note:** The Building Official shall be consulted about penetration of fire separations, height and area, or other limitations.

**Note:** The following sections of the Uniform Plumbing Code apply to Odor Control Systems for Water Closets.

103.5	Inspection
Chapter 2	Definitions
301.1	Minimum Standards
310.0	Workmanship
311.0	Prohibited Fittings and Practices
311.8	Screwed Fittings
313.0	Protection of Piping, Materials, and Structures
314.0	Hangers and Supports
316.0	Joints and Connections
316.4	Prohibited Joints and Connections
317.0	Increases and Reducers
Chapter 7	Sanitary Drainage
701.0	Materials (Drainage)
701.2	Fittings
903.0	Materials (Venting)
1101.3	Material Uses
Table 14-1	Materials
ASME B 16.23	Cast Bronze Solder-Joint Drainage Fittings—DWV
ASME B 16.29	Wrought Copper and Copper Alloy Solder-Joint Drainage Fittings
ASTM A 74	Cast Iron Soil Pipe and Fittings
ASTM A 888	Specifications for Hubless Cast Iron Soil Pipe and Fittings for Sanitary and Storm Drain, Waste, and

ASTM B 42	Vent Piping Applications Specification for Seamless Copper Pipe, Standard Sizes
ASTM B 302	Specification for Threadless Copper Pipe
ASTM B 306	Specification for Copper Drainage Tube (DWV)
ASTM B 828	Standard Practice for Making Capillary Joints by Soldering of Copper and Copper Alloy Tube and Fittings
ASTM D 2564	Solvent Cements for Poly (Vinyl Chloride) (PVC) Plastic Piping Systems
ASTM D 2661	Acrylonitrile-Butadiene-Styrene (ABS) Sch. 40 Plastic Drain, Waste, and Vent Pipe and Fittings
ASTM D 2665	Poly(Vinyl Chloride) (PVC) Plastic Drain, Waste, and Vent Pipe and Fittings
ASTM D 3311	Drain, Waste, and Vent (DWV) Plastic Fitting Patterns ( <b>Note:</b> Although referenced in this standard, some of the fittings shown in the standard are not acceptable under the Uniform Plumbing Code.)
ASTM F 402	Safe Handling of Solvent Cement, Primers, and Cleaners Used for Joining Thermoplastic Pipe and Fittings
ASTM F 628	Acrylonitrile-Butadiene-Styrene (ABS) Sch. 40 Plastic Drain, Waste, and Vent Pipe with a Foam Core
ASTM F 656	Primers for Use in Solvent Cement Joints of Poly (Vinyl Chloride) (PVC) Plastic Pipe and Fittings
CISPI 301	Hubless Cast-iron Soil Pipe and Fittings for

	Sanitary and Storm Drain, Waste, and Vent Piping Applications
IAPMO IS 3	Copper Plumbing Tube, Pipe, and Fittings
IAPMO IS 5	ABS Building Drain, Waste, and Vent Pipe and Fittings
IAPMO IS 6	Hubless Cast-Iron Sanitary and Rainwater Systems
IAPMO IS 9	PVC Building Drain, Waste, and Vent Pipe and Fittings
UL 1004	Electric Motors

was selected to adequately handle the maximum possible water rise generated during the flushometer flushing cycle.

**Manifold** – The odor control manifold, including all horizontal piping within the odor control system, shall be 1/8 inch per foot horizontally sloped back to the last riser. The manifold shall be made from approved DWV material no smaller than the pipe size as determined by using Table 1 of this installation standard. No traps are permitted within the odor control piping system.

Figures 1 and 2 illustrate the basic configuration to be used for the design of any odor control system installed in accordance with this installation standard.

**301.1 Minimum Standards**

**301.1.1 Materials**

All materials shall comply with the appropriate standards in Table 14-1 of the UPC.

**701.0 Materials**

All pipe and fittings shall be made from approved DWV materials and shall be installed in accordance with the requirements of Chapter 7 of the Uniform Plumbing Code, titled Sanitary Drainage. In addition, all pipe and fittings shall be installed in accordance with the applicable IAPMO Installation Standard.

**SYSTEM SIZING**

**Minimum Inlet Flow Rate** – The odor control system shall provide a minimum average air flow rate of 5 cfm at each inlet connection (tee).

**Minimum Inlet Draft** – The odor control system shall provide a minimum average draft of 1/4 inch WC (water column) as measured inside the inlet connection (tee) or a minimum of 0.10 inch of WC at the small perforations in the top rim of the water closet bowl.

**EXHAUST FAN**

The exhaust fan shall be listed for installation in outdoor and wet locations and in conditioned airstreams up to 140°F and shall comply with the applicable requirements of UL 1004.

The odor control system exhaust fan shall be installed in accordance with local building and electrical code requirements and shall comply with drainage venting termination requirements of the Uniform Plumbing Code.

**SYSTEM TESTING**

Measure the suction pressure at any perforation of the water closet rim. The minimum reading should be 0.10 inch of water column.

**ADOPTED: 2001**

**ODOR CONTROL SYSTEM COMPONENTS**

**Inlet Connection** – The inlet for DWV odor control systems shall be connected at the tailpiece of the flushometer-operated water closet using a listed tee. The tee shall immediately transition to the odor control riser using approved DWV pipe and fittings.

**Riser** – The odor control riser shall be made from listed DWV pipe no smaller than 2-1/2 inch diameter. This minimum riser size was selected to adequately handle the required minimum odor control air flow rate. The riser height shall be a minimum of 6 feet as measured from the connection at the sanitary tee to the overhead connection at the odor control manifold. The minimum riser height

**TABLE 1  
MAXIMUM ALLOWABLE NUMBER OF WATER CLOSETS  
CONNECTED TO AN EXHAUST MANIFOLD**

Pipe Diameter (inches)	2-1/2	3	4	5	6	8
Maximum No. of Water Closets	2	3	6	8	10	22

**Note:** For conditions other than those covered in Table 1, the exhaust manifold and the main exhaust riser to the odor control system exhaust fan shall be sized to maintain an average air velocity of 300 ±50 feet per minute.

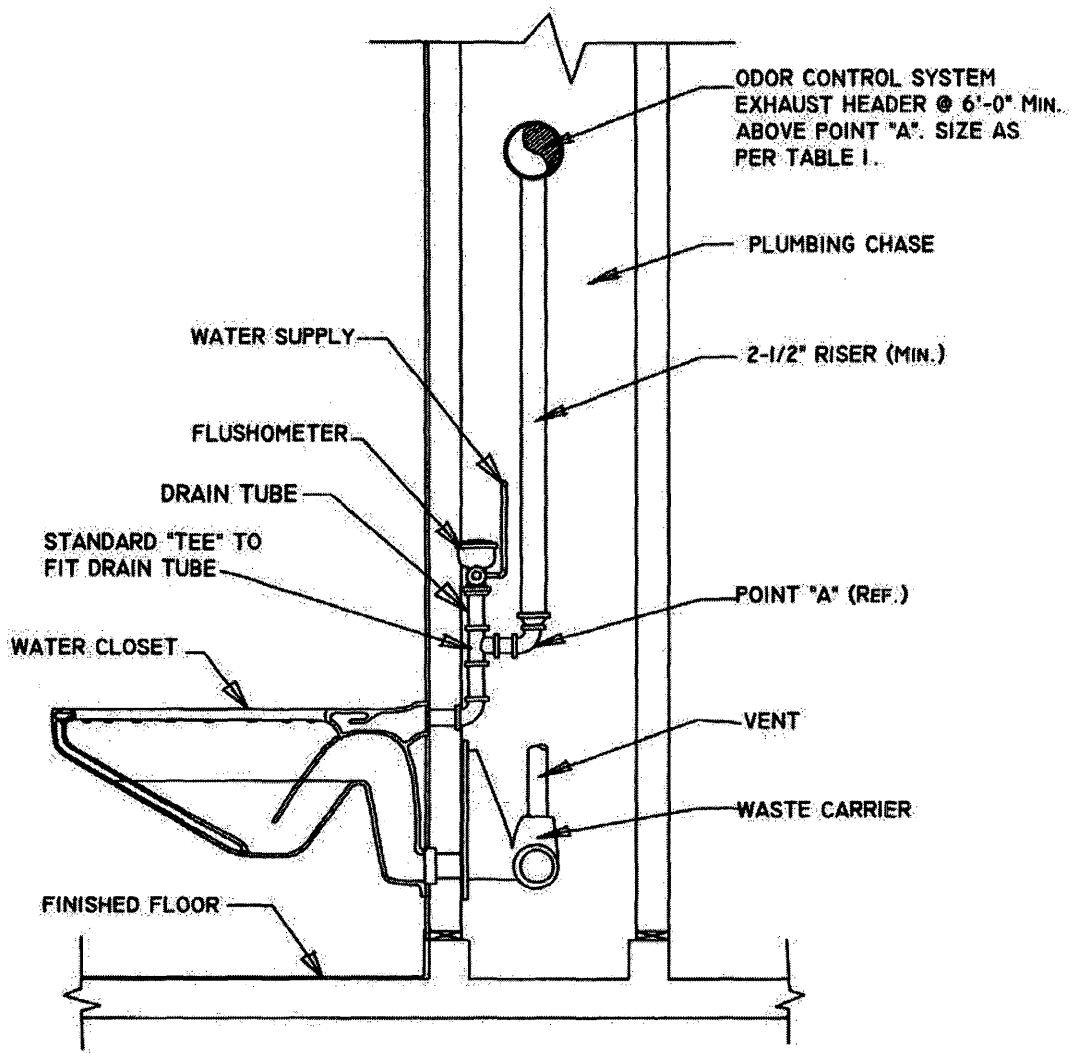

FIGURE 1

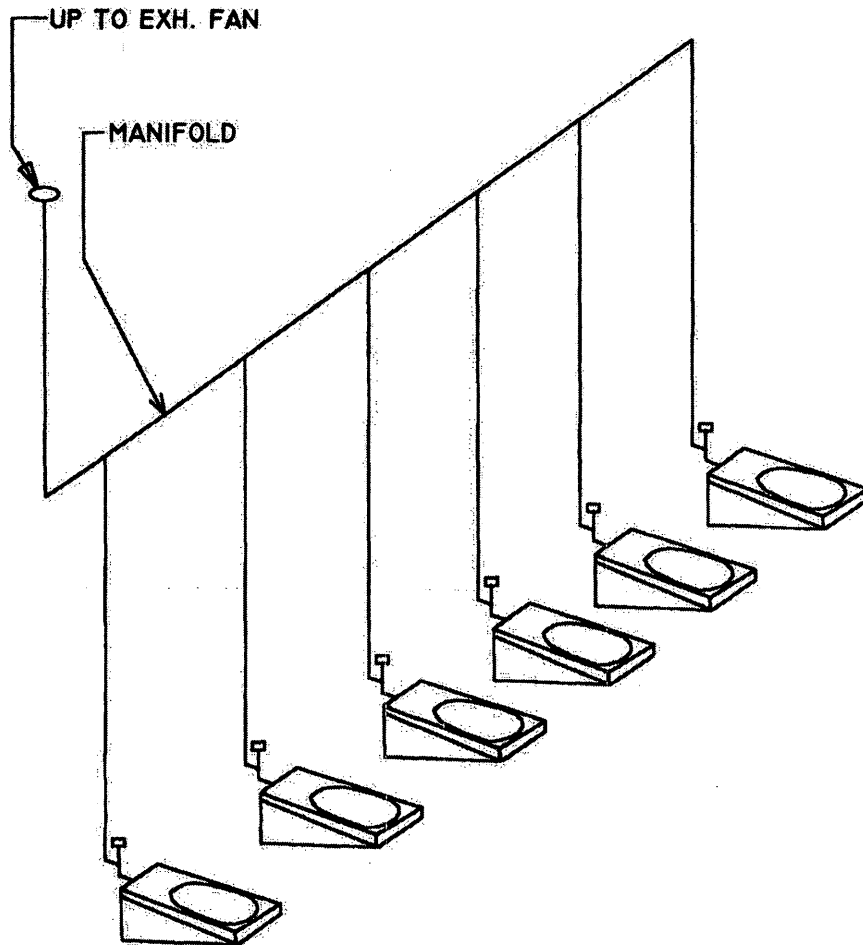

FIGURE 2

**Installation Standard  
For  
COMPOSITE PEX-AL-PEX HOT AND PE-AL-PE COLD  
WATER DISTRIBUTION SYSTEMS**

**IAPMO IS 28-2002**

This standard shall govern the installation of composite piping in potable hot and cold water distribution systems within and under buildings and shall apply only to PEX-AL-PEX and PE-AL-PE piping that meets the requirements of ASTM F 1281 and ASTM F 1282. Installation, materials, and inspection should comply with the current edition of the Uniform Plumbing Code published by the International Association of Plumbing and Mechanical Officials and shall also comply with this standard and the manufacturer's installation recommendations.

**Note:** The following sections of the Uniform Plumbing Code shall apply to composite PEX-AL-PEX and PE-AL-PE tubing.

310.0	Workmanship
313.0	Protection of Piping, Materials, and Structures
316.1.4	Types of Joints
316.2.3	Connections to Other Materials
Chapter 6	Water Distribution

**Chapter 2\*      Definitions**

ASTM	American Society for Testing and Materials
IAPMO	International Association of Plumbing and Mechanical Officials
PEX-AL-PEX	Crosslinked Polyethylene-Aluminum-Crosslinked Polyethylene
PE-AL-PE	Polyethylene Aluminum-Polyethylene
UPC	Uniform Plumbing Code as published by IAPMO

**301.1      Materials and Fittings**

**301.1.1      Materials** – Materials shall comply with the following requirements:

<b>Materials</b>	<b>ASTM Standard</b>
Crosslinked Polyethylene-Aluminum-Crosslinked Polyethylene (PEX-AL-PEX)	F 1281
Polyethylene-Aluminum-Polyethylene (PE-AL-PE)	F 1282
Metal Insert Fittings for PEX-AL-PEX and PE-AL-PE composite pipe	F 1974

**301.1.1.1      Piping** – PEX-AL-PEX composite pipe shall comply with ASTM F 1281. PE-AL PE composite pipe shall comply with ASTM F 1282.

**301.1.1.2      Fittings** – Fittings shall be metal insert-type and shall comply with ASTM F 1974. Fittings are limited to the following types:

- (a) Insert fittings or compression-type fittings,
- (b) Special listed fittings of other types.

Connections to galvanized pipe or fittings shall be specifically designed for that purpose.

**NOTE 1:      Manufacturers of fittings shall recommend assembly procedures.**

**301.1.2      Markings**

**301.1.2.1      Piping** – Composite piping shall be legibly marked at intervals of not more than 5 ft. (1.5 m) with at least the following:

- (a) Manufacturer's name or trademark;
- (b) ASTM F 1281 (PEX-AL-PEX) or F 1282 (PE-AL-PE);
- (c) Piping size;
- (d) Material type – PEX-AL-PEX or PE-AL-PE;



- (e) Pressure ratings at 125 psi (862 kPa) at 180°F (82°C) (PEX-AL-PEX)\* or, 200 psi (1380 kPa) at 73°F (23°C) (PE-AL-PE)\*;
- (f) Mark of an acceptable certification agency; and
- (g) Manufacturer's date and material code.

\* The elevated temperature and pressure ratings for PEX-AL-PEX and PE-AL-PE in accordance with ASTM F 1281 and ASTM F 1282 are

PEX-AL-PEX (orange colored)	200 psi at 73°F	125 psi at 180°F
PE-AL-PE (blue colored)	200 psi at 73°F	160 psi at 140°F

- 301.1.2.2 Fittings** – Fittings shall be marked with at least the following:
- (a) Manufacturer's name or trademark or other acceptable markings;
  - (b) The mark of an acceptable certification agency;
  - (c) If size permits, ASTM F 1974.

**301.1.3 Position of Markings** – When practical, markings shall be visible for inspection. Markings shall be visible prior to installation.

**313.0 Protection of Piping**

**313.1 Abrasion** – Piping passing through metallic studs, joists, or hollow masonry walls shall be protected from abrasion or sharp edges by elastomeric or plastic sleeves, grommets, conical-shaped punch holes, or other approved means.

**313.2 Puncture** – Steel plate protection, minimum 18 gauge, shall be installed when the tubing is within 1" (25 mm) of the nailing surface.

**313.3 Exposed Piping**

**313.3.1 General** – Where exposed tubing may be subjected to mechanical damage it must be protected.

**313.4 Freezing** – In areas where the system must be drained to protect the system from freezing, horizontal lines shall be graded to drain.

**313.5 Storage** – Piping shall be stored in a way to protect the system from mechanical damage (slitting, puncturing, etc.). Piping should be stored under cover to

keep it clean and avoid long-term exposure to sunlight. Consult piping manufacturer for recommended limits for outside storage.

**313.6 Thermal Expansion**

**313.6.1 General** – The linear expansion rate for PEX-AL-PEX and PE-AL-PE is 1.56 in. (39.6 mm) per 100 ft. (30m) of tube per 100°F (55°C) change in temperature. No accommodation for thermal expansion is required.

**313.7 Clearance** – Bored holes and sleeves shall provide adequate clearance between the piping and structure to allow for free longitudinal movement.

**314.0 Hangers and Supports**

**314.1 Vertical Piping** – Vertical piping shall be supported at every floor. Piping shall have a midstory guide.

**314.2 Horizontal Piping** – Horizontal piping shall be supported according to Table 314.2.

**TABLE 314.2  
Support Spacing**

Nominal Diameter	Spacing
1/2", 3/4", and 1"	8 ft 2 in. (2489 mm)

**314.3 Hangers and Anchors** – Piping shall not be anchored rigidly to a support but shall be secured with hangers or straps that provide for a degree of movement and that prevent damage to the tubing. Do not use hangers or straps with sharp or abrasive edges. Do not use hangers that pinch the piping.

**314.4 Inspection and Testing**

**A. Inspection** – All tubing shall be properly seated onto the fitting per the manufacturer's instructions. Buckled, gouged, or obviously damaged pipe shall not be used. Consult manufacturer's recommendations for repair procedures.

**B. Testing** – Upon completion of a section or of the entire hot-and cold-water supply system it shall be tested and proved tight under a water pressure or air test not less than the working pressure under which it is to be used. The water used for tests shall be obtained from a potable source. The system shall withstand the test without leaking for a period of not less than fifteen (15) minutes.

**316.1 Joints and Connections**

**316.1.1 Procedure** – Piping should be cut with a pipe cutter designed specifically for composite pipe. Piping shall be cut square, i.e., perpendicular to the length. If other cutting methods are used, care must be taken to remove any excess material, flashing, or burrs.

**316.1.2 Tools** – Fitting manufacturer’s recommended tool shall be used with the composite insert fitting systems. For specific procedures, follow the manufacturer’s recommendations.

**316.2 Transition Joints**

**316.2.1 Fittings** – Transitions for composite tubing to metal piping or valves shall be made only with transition fittings intended for that purpose.

**606.0 Joints** – Joints shall not be allowed in piping installed in or under a concrete slab resting on grade unless for repair within a building structure. All repair joints must be properly protected with a heat shrink sleeve. All slab penetrations shall be sleeved.

**608.0 Pressure Relief Valves**

**608.1 PEX-AL-PEX Piping** – PEX-AL-PEX piping used for temperature and/or pressure relief valve drain lines shall be graded to the outlet end and shall be supported at a maximum of 8 ft. 2 in. (2489 mm) intervals horizontally. Vertical piping shall be supported at every floor. Vertical piping shall have a midstory guide.

**609.0 Installation**

**609.1 Bends** – Piping shall be installed by bending the composite pipe by hand to a minimum radius of 5 times the nominal pipe diameter. External bend supports or sleeves are not required as the composite piping is rigid after bending.

**609.2 Damage** – Kinked, buckled, gouged, or other obviously damaged pipe shall not be used.

**609.3 Finish Nipples** – Finish nipples shall be connected to drop-ear fittings to prevent rotation. Finish nipples shall not be PEX.

**609.4 Hose Bibs** – The piping directly connected to any hose bib shall be so anchored that the load on the hose bib will not strain the composite piping.

**609.5 Heated Joints** – An open flame shall not be applied to PEX-AL-PEX or PE-

AL-PE piping when brazing, soldering or welding joints.

**609.6 Working Pressure and Temperature** – Long-term working pressures for the PEX-AL-PEX shall not exceed a maximum of 115 psi (793 kPa), and the long-term working temperature shall not exceed 210°F (99°C). Long-term working pressures for the PE-AL-PE shall not exceed a maximum of 160 psi (1103.2 kPa), and the long-term working temperature shall not exceed 140°F (60°C).

**609.7 Exposure to Sunlight** – Only UV-stabilized composite piping can be subjected to direct sunlight after installation and can be installed on the surface of the building. Kitec pipe contains an ultraviolet (UV) inhibitor to withstand limited exposure to UV light. Manufacturer recommends placing the unused portion of a Kitec coil back in the product’s box rather than storing in the sunlight while not in use.

**609.8 Water Heater Connections** – PEX-AL-PEX or PE-AL-PE piping shall not be installed within the first eighteen inches (18) (457 mm) of piping connected to a water heater.

**609.10 Water Hammer Arresters** – A composite hot-water system will withstand repeated pressure surges, well in excess of its rated pressure. The Uniform Plumbing Code requires a means of attenuating water hammers. Consequently, water hammer arrestors may be advisable when solenoid valves or other quick closing devices are used in the system. In designing for such situations, it is advisable to consult the pipe or fittings manufacturer for recommended surge pressure limits. Water hammer and surge pressure calculations are reviewed in Chapter 7, AWWA Manual M-11.

**610.0 Sizing**

**610.1.1 Method** – Piping shall be sized in accordance with UPC Section 610.0. When UPC Appendix A is applicable, use Table 610.1.2.

Add equivalent lengths from Table 610.1.3 when determining developed length.

Maximum velocities through PEX-AL-PEX and PE-AL-PE copper alloy fittings shall be limited to eight (8) feet per second (fps) (2.4 mps) in cold water and five (5) feet per second (fps) (1.52 mps) in hot water.

**Adopted: 2002**

**TABLE 610.1.2**

Flow Rate U.S. GPM	1/2"		3/4"		1"	
	Head Loss	Velocity	Head Loss	Velocity	Head Loss	Velocity
	Psi/c.ft	Ft./s	Psi/c.ft	Ft./s	Psi/c.ft	Ft./s
0.10	0.02	0.2	0.002	0.07	0.001	0.04
0.20	0.1	0.4	0.01	0.1	0.002	0.08
0.3	0.2	0.6	0.02	0.2	0.005	0.1
0.4	0.3	0.7	0.03	0.3	0.009	0.2
0.5	0.5	0.9	0.04	0.3	0.01	0.2
0.6	0.6	1.1	0.05	0.4	0.02	0.3
0.7	0.9	1.3	0.07	0.5	0.02	0.3
0.8	1.1	1.5	0.09	0.5	0.03	0.3
0.9	1.4	1.7	0.1	0.6	0.04	0.4
1.0	1.6	1.8	0.1	0.7	0.05	0.4
2.0	5.9	3.7	0.5	1.3	0.2	0.9
3.0	12.5	5.5	1.0	2.0	0.4	1.3
4.0	21.3	7.3	1.8	2.6	0.6	1.7
5.0			2.7	3.3	2.1	0.9
6.0			3.8	4.0	1.2	1.5
7.0			5.0	4.6	3.0	1.7
8.0			6.4	5.3	3.4	2.2
9.0			8.0	5.9	3.8	2.7
10.0			9.7	6.6	4.2	3.3
11.0			11.6	7.2	4.6	3.9
12.0			13.6	7.9	5.0	4.6
13.0				5.3		
14.0				5.9		
15.0					6.9	6.3
16.0					7.8	6.3
17.0					8.7	6.7
18.0					9.7	7.1
19.0					10.7	7.6
20.0					11.8	8.0

**TABLE 610.1.3  
Developed Length**

Sizes, Inches	Type of Fittings	Equivalent Length of Pipe (Feet)
1/2	Couplings	2
	Adapters	2
	Elbows	7.5
	Tees (Branch Flow)	8
	Tees (On the Run)	2.5
3/4	Couplings	2
	Adapters	2
	Elbows	8.5
	Tees (Branch Flow)	10.5
	Tees (On the Run)	2.5
1	Couplings	2
	Adapters	2
	Elbows	9
	Tees (Branch Flow)	11

## APPENDIX J

### RECLAIMED WATER SYSTEMS FOR NON-RESIDENTIAL BUILDINGS

#### J 1 Reclaimed Water Systems – General.

(A) The provisions of this appendix shall apply to the installation, construction, alteration, and repair of reclaimed water systems intended to supply water closets, urinals, and trap primers for floor drains and floor sinks. Use is limited to these fixtures that are located in non-residential buildings. Fixtures within residential buildings are excluded from the list of approved uses. The reclaimed water system shall have no connection to any potable water system, with or without mechanical backflow prevention devices. If reclaimed water is utilized on the premises, all potable water supplies shall be provided with appropriate backflow protection, as required by the Authority Having Jurisdiction. Except as otherwise provided for in this appendix, the provisions of this code shall be applicable to reclaimed water system installations.

(B) No permit for any reclaimed water system shall be issued until complete plumbing plans, with appropriate data satisfactory to the Authority Having Jurisdiction, have been submitted and approved. No changes or connections shall be made to either the reclaimed water system or the potable water system within any site containing a reclaimed water system without approval by the Authority Having Jurisdiction.

(C) Before the building may be occupied, the installer shall perform the initial cross-connection test in the presence of the Authority Having Jurisdiction and other authorities having jurisdiction. The test shall be ruled successful by the Authority Having Jurisdiction before final approval is granted.

#### J 2 Definitions.

Reclaimed water is water which, as a result of tertiary treatment of domestic wastewater by a public agency, is suitable for a direct beneficial use or a controlled use that would not otherwise occur. The level of treatment and quality of the reclaimed water shall be approved by the public health Authority Having Jurisdiction.

For the purpose of this appendix, tertiary treatment shall result in water which is adequately oxidized, clarified, coagulated, filtered, and disinfected so that at some location in the treatment process, the seven (7) day median number of total

coliform bacteria in daily samples does not exceed two and two-tenths (2.2) per one hundred (100) milliliters, and the number of total coliform bacteria does not exceed twenty-three (23) per one hundred (100) milliliters in any sample. The water shall be filtered so that the daily average turbidity does not exceed two (2) turbidity units upstream from the disinfection process.

Specifically excluded from this definition is gray water, which is defined in Appendix G of this code.

#### J 3 Permit.

It shall be unlawful for any person to construct, install, alter, or cause to be constructed, installed, or altered any reclaimed water system within a building or on a premises without first obtaining a permit to do such work from the Authority Having Jurisdiction.

#### J 4 Drawings and Specifications.

The Authority Having Jurisdiction may require any or all of the following information to be included with or in the plot plan before a permit is issued for a reclaimed water system.

(A) A plot plan drawn to scale completely dimensioned, showing lot lines structures location of all present and proposed potable water supplies and meters, water wells, streams, auxiliary water supply and systems, reclaimed water supply and meters, drain lines, and locations of private sewage disposal systems and one hundred (100) percent expansion areas, or building sewer connected to the public sewer.

(B) Details of construction including riser diagrams or isometrics and a full description of the complete installation, including installation methods, construction, and materials as required by the Authority Having Jurisdiction. To the extent permitted by structural conditions, all reclaimed water risers within the toilet room, including appurtenances such as air/vacuum relief valves, pressure reducing valves, etc., shall be installed in the opposite end of the room containing the served fixtures from the potable water risers or opposite walls, as applicable. To the extent permitted by structural conditions, reclaimed water headers and branches off risers shall not be run in the same wall or ceiling cavity of the toilet room where potable water piping is run.

(C) Detailed initial and annual testing requirements as outlined elsewhere in this appendix.

**J 5 Pipe Material/Pipe Identification.**

Reclaimed water piping and fittings shall be as required in this code for potable water piping and fittings. All reclaimed water pipe and fittings shall be continuously wrapped with purple-colored Mylar tape. The wrapping tape shall have a minimum nominal thickness of five ten-thousandths (0.0005) inch (0.127 mm) and a minimum width of two (2) inches (51 mm). Tape shall be fabricated of poly(vinyl chloride) with a synthetic rubber adhesive and a clear polypropylene protective coating or approved equal. The tape shall be purple (Pantone color #512) and shall be imprinted in nominal one-half (1/2) inch (12.7 mm) high, black uppercase letters, with the words "CAUTION: RECLAIMED WATER, DO NOT DRINK." The lettering shall be imprinted in two (2) parallel lines, such that after wrapping the pipe with a one-half (1/2) width overlap, one (1) full line of text shall be visible. Wrapping tape is not required for buried PVC pipe manufactured with purple color integral to the plastic and marked on opposite sides to read "CAUTION: RECLAIMED WATER, DO NOT DRINK" in intervals not to exceed three (3) feet (914 mm).

All valves except fixture supply control valves shall be equipped with a locking feature. All mechanical equipment which is appurtenant to the reclaimed water system shall be painted purple to match the Mylar wrapping tape.

**J 6 Installation.**

**(A)** Hose bibbs shall not be allowed on reclaimed water piping systems.

**(B)** The reclaimed water system and the potable water system within the building shall be provided with the required appurtenances (valves, air/vacuum relief valves, etc.) to allow for deactivation or drainage as may be required by J 8 of this appendix.

**(C)** Reclaimed water pipes shall not be run or laid in the same trench as potable water pipes. A ten (10) foot (3048 mm) horizontal separation shall be maintained between pressurized, buried reclaimed and potable water piping. Buried potable water pipes crossing pressurized reclaimed water pipes shall be laid a minimum of twelve (12) inches (305 mm) above the reclaimed water pipes. Reclaimed water pipes laid in the same trench or crossing building sewer or drainage piping shall be installed in compliance with Sections 609.0 and 720.0 of this code. Reclaimed water pipes shall be protected similar to potable water pipes.

**J 7 Signs.**

**(A) Room Entrance Signs.** All installations using reclaimed water for water closets and/or urinals shall be identified with signs. Each sign shall contain one-half (1/2) inch (12.7 mm) letters of a highly visible color on a contrasting background. The location of the sign(s) shall be such that the sign(s) shall be visible to all users. The number and location of the signs shall be approved by the Authority Having Jurisdiction and shall contain the following text:

**TO CONSERVE WATER, THIS BUILDING USES  
RECLAIMED  
WATER TO FLUSH TOILETS AND URINALS.**

**(B) Equipment Room Signs.** Each equipment room containing reclaimed water equipment shall have a sign posted with the following wording in one (1) inch (25.4 mm) letters on a purple background:

**CAUTION  
RECLAIMED WATER, DO NOT DRINK.  
DO NOT CONNECT TO DRINKING WATER  
SYSTEM.**

**NOTICE  
CONTACT BUILDING MANAGEMENT BEFORE  
PERFORMING ANY WORK ON THIS WATER  
SYSTEM.**

This sign shall be posted in a location that is visible to anyone working on or near reclaimed water equipment.

**(C)** Where tank-type water closets are flushed with reclaimed water, the tank shall be labeled:

**RECLAIMED WATER – DO NOT DRINK**

**(D) Valve Access Door Signs.** Each reclaimed water valve within a wall shall have its access door into the wall equipped with a warning sign approximately six (6) inches by six (6) inches (152 mm x 152 mm) with wording in one half (1/2) inch (12.7 mm) letters on a purple background. The size, shape, and format of the sign shall be substantially the same as that specified in subsection (B) above. The signs shall be attached inside the access door frame and shall hang in the center of the access door frame. This sign requirement shall be applicable to any and all access doors, hatches, etc., leading to reclaimed water piping and appurtenances.

**(E) Valve Seals.** Each valve or appurtenance shall be sealed in a manner approved by the Authority Having Jurisdiction after the reclaimed system has been approved and placed into operation. These seals shall either be a crimped lead wire seal or a plastic breakaway seal which, if broken after system approval, shall be deemed conclusive evidence that the reclaimed water system has been accessed. The seals shall be purple with the words "RECLAIMED WATER" and shall be supplied by the reclaimed water purveyor or by other arrangements acceptable to the Authority Having Jurisdiction.

### J 8 Inspection and Testing.

**(A)** Reclaimed water piping shall be tested as outlined in this code for testing of potable water piping.

**(B)** An initial and subsequent annual cross-connection inspection and test shall be performed on both the potable and reclaimed water systems as follows.

**(1) Visual Dual System Inspection.** Prior to commencing the cross-connection testing, a dual system inspection shall be conducted by the Authority Having Jurisdiction and other authorities having jurisdiction.

- (i) Meter locations of the reclaimed water and potable water lines shall be checked to verify that no modifications were made, and that no cross-connections are visible.
- (ii) All pumps and equipment, equipment room signs, and exposed piping in equipment room shall be checked.
- (iii) All valves shall be checked to ensure that valve lock seals are still in place and intact. All valve control door signs shall be checked to verify that no signs have been removed.

**(2) Cross-Connection Test.** The following procedure shall be followed by the applicant in the presence of the Authority Having Jurisdiction and other authorities having jurisdiction to determine whether a cross-connection occurred.

- (i) The potable water system shall be activated and pressurized. The reclaimed water system shall be shut down and completely drained.
- (ii) The potable water system shall remain pressurized for a minimum period of time specified by the Authority Having Jurisdiction while the reclaimed water

system is empty. The minimum period the reclaimed water system is to remain depressurized shall be determined on a case-by-case basis, taking into account the size and complexity of the potable and reclaimed water distribution systems, but in no case shall that period be less than one (1) hour.

- (iii) All fixtures, potable and reclaimed, shall be tested and inspected for flow. Flow from any reclaimed water system outlet shall indicate a cross-connection. No flow from a potable water outlet would indicate that it may be connected to the reclaimed water system.
  - (iv) The drain on the reclaimed water system shall be checked for flow during the test and at the end of the period.
  - (v) The potable water system shall then be completely drained.
  - (vi) The reclaimed water system shall then be activated and pressurized.
  - (vii) The reclaimed water system shall remain pressurized for a minimum period of time specified by the Authority Having Jurisdiction while the potable water system is empty. The minimum period the potable water system is to remain depressurized shall be determined on a case-by-case basis, but in no case shall that period be less than one (1) hour.
  - (viii) All fixtures, potable and reclaimed, shall be tested and inspected for flow. Flow from any potable water system outlet shall indicate a cross-connection. No flow from a reclaimed water outlet would indicate that it may be connected to the potable water system.
  - (ix) The drain on the potable water system shall be checked for flow during the test and at the end of the period.
  - (x) If there is no flow detected in any of the fixtures which would have indicated a cross-connection, the potable water system shall be repressurized.
- (3)** In the event that a cross-connection is discovered, the following procedure, in the presence of the Authority Having Jurisdiction, shall be activated immediately:
- (i) Reclaimed water piping to the building shall be shut down at the meter, and the reclaimed water riser shall be drained.

- (ii) Potable water piping to the building shall be shut down at the meter.
- (iii) The cross-connection shall be uncovered and disconnected.
- (iv) The building shall be retested following procedures listed in subsections (B)(1) and (B)(2) above.
- (v) The potable water system shall be chlorinated with fifty (50) ppm chlorine for twenty-four (24) hours.
- (vi) The potable water system shall be flushed after twenty-four (24) hours, and a standard bacteriological test shall be performed. If test results are acceptable, the potable water system may be recharged.

**(C)** An annual inspection of the reclaimed water system, following the procedures listed in subsection J 8 (B)(1), shall be required. Annual cross-connection testing, following the procedures listed in subsection J 8 (B)(2), shall be required by the Authority Having Jurisdiction, unless site conditions do not require it. In no event shall the test occur less often than once in four (4) years. Alternate testing requirements may be allowed by the Authority Having Jurisdiction for institutional buildings.

The health officer or other designated appointee may substitute for the Authority Having Jurisdiction in the above-mentioned inspections and tests.

#### **J 9 Sizing.**

Reclaimed water piping shall be sized as outlined in this code for sizing potable water piping.

#### **J 10 Approved Uses of Reclaimed Water.**

Reclaimed water is allowed in all non-residential buildings to supply fixtures as specified in this appendix, except where prohibited by statute, regulation, or ordinance.

## APPENDIX K

### PRIVATE SEWAGE DISPOSAL SYSTEMS

#### **K 1 Private Sewage Disposal – General.**

**(A)** Where permitted by Section 713.0, the building sewer may be connected to a private sewage disposal system complying with the provisions of this appendix. The type of system shall be determined on the basis of location, soil porosity, and groundwater level, and shall be designed to receive all sewage from the property. The system, except as otherwise approved, shall consist of a septic tank with effluent discharging into a subsurface disposal field, into one (1) or more seepage pits, or into a combination of subsurface disposal field and seepage pits. The Authority Having Jurisdiction may grant exceptions to the provisions of this appendix for permitted structures which have been destroyed due to fire or natural disaster and which cannot be reconstructed in compliance with these provisions. (See TIA on page vii)

**(B)** Where the quantity or quality of the sewage is such that the above system cannot be expected to function satisfactorily for commercial, agricultural, and industrial plumbing systems; for installations where appreciable amounts of industrial or indigestible wastes are produced; for occupancies producing abnormal quantities of sewage or liquid waste; or when grease interceptors are required by other parts of this code, the method of sewage treatment and disposal shall be first approved by the Authority Having Jurisdiction. Special sewage disposal systems for minor, limited, or temporary uses shall be first approved by the Authority Having Jurisdiction.

**(C)** Disposal systems shall be designed to utilize the most porous or absorptive portions of the soil formation. Where the groundwater level extends to within twelve (12) feet (3658 mm) or less of the ground surface or where the upper soil is porous and the underlying stratum is rock or impervious soil, a septic tank and disposal field system shall be installed.

#### **New (D) – See TIA on Page vii**

**(D)** All private sewage disposal systems shall be so designed that additional seepage pits or subsurface drain fields, equivalent to at least one hundred (100) percent of the required original system, may be installed if the original system cannot absorb all the sewage. No division of the lot or erection of structures on the lot shall be made if such division or structure impairs the usefulness of the one hundred (100) percent expansion area.

**(E)** No property shall be improved in excess of its capacity to properly absorb sewage effluent by the means provided in this code.

**Exception:** The Authority Having Jurisdiction may, at his discretion, approve an alternate system.

**(F)** No private sewage disposal system, or part thereof, shall be located in any lot other than the lot which is the site of the building or structure served by such private sewage disposal system, nor shall any private sewage disposal system or part thereof be located at any point having less than the minimum distances indicated in Table K-1.

Nothing contained in this code shall be construed to prohibit the use of all or part of an abutting lot to provide additional space for a private sewage disposal system or part thereof when proper cause, transfer of ownership, or change of boundary not in violation of other requirements has been first established to the satisfaction of the Authority Having Jurisdiction. The instrument recording such action shall constitute an agreement with the Authority Having Jurisdiction which shall clearly state and show that the areas so joined or used shall be maintained as a unit during the time they are so used. Such agreement shall be recorded in the office of the County Recorder as part of the conditions of ownership of said properties and shall be binding on all heirs, successors, and assigns to such properties. A copy of the instrument recording such proceedings shall be filed with the Authority Having Jurisdiction.

**(G)** When there is insufficient lot area or improper soil conditions for adequate sewage disposal for the building or land use proposed, and the Authority Having Jurisdiction so finds, no building permit shall be issued and no private sewage disposal shall be permitted. Where space or soil conditions are critical, no building permit shall be issued until engineering data and test reports satisfactory to the Authority Having Jurisdiction have been submitted and approved.

**(H)** Nothing contained in this appendix shall be construed to prevent the Authority Having Jurisdiction from requiring compliance with higher requirements than those contained herein, where such higher requirements are essential to maintain a safe and sanitary condition.



(l) Alternate systems may be used only by special permission of the Authority Having Jurisdiction after being satisfied of their adequacy. This authorization may be based on extensive field and test data from conditions similar to those at the proposed site or may require such additional data as may be necessary to provide assurance that the alternate system will produce continuous and long-range results at the proposed site, at least equivalent to systems which are specifically authorized.

If demonstration systems are to be considered for installation, conditions for installation, maintenance, and monitoring at each such site shall first be established by the Authority Having Jurisdiction.

**Aerobic Systems.** Approved aerobic systems may be substituted for conventional septic tanks provided the Authority Having Jurisdiction is satisfied that such systems will produce results at least equivalent to septic tanks, whether their aeration systems are operating or not.

## K 2 Capacity of Septic Tanks.

The liquid capacity of all septic tanks shall conform to Tables K-2 and K-3 as determined by the number of bedrooms or apartment units in dwelling occupancies and the estimated waste/sewage design flow rate or the number of plumbing fixture units as determined from Table 7-3, whichever is greater in other building occupancies. The capacity of any one septic tank and its drainage system shall be limited by the soil structure classification, as specified in Table K-5.

## K 3 Area of Disposal Fields and Seepage Pits.

The minimum effective absorption area in disposal fields in square feet ( $m^2$ ), and in seepage pits in square feet ( $m^2$ ) of side wall, shall be predicated on the required septic tank capacity in gallons (liters) and/or estimated waste/sewage flow rate, whichever is greater, and shall conform to Table K-4 as determined for the type of soil found in the excavation, and shall be as follows:

- (1) When disposal fields are installed, a minimum of one hundred and fifty (150) square feet ( $14 m^2$ ) of trench bottom shall be provided for each system exclusive of any hard pan, rock, clay, or other impervious formations. Side wall area in excess of the required twelve (12) inches (305 mm) and not to exceed thirty-six (36) inches (914 mm) below the leach line may be added to the trench bottom area when computing absorption areas.

- (2) Where leaching beds are permitted in lieu of trenches, the area of each such bed shall be at least fifty (50) percent greater than the tabular requirements for trenches. Perimeter side wall area in excess of the required twelve (12) inches (305 mm) and not to exceed thirty-six (36) inches (914 mm) below the leach line may be added to the trench bottom area when computing absorption areas.
- (3) No excavation for a leach line or leach bed shall extend within five (5) feet (1524 mm) of the water table nor to a depth where sewage may contaminate the underground water stratum that is usable for domestic purposes.

**Exception:** In areas where the records or data indicate that the groundwaters are grossly degraded, the five (5) foot (1524 mm) separation requirement may be reduced by the Authority Having Jurisdiction. The applicant shall supply evidence of groundwater depth to the satisfaction of the Authority Having Jurisdiction.

- (4) The minimum effective absorption area in any seepage pit shall be calculated as the excavated side wall area below the inlet exclusive of any hardpan, rock, clay, or other impervious formations. The minimum required area of porous formation shall be provided in one or more seepage pits. No excavation shall extend within ten (10) feet (3048 mm) of the water table nor to a depth where sewage may contaminate underground water stratum that is usable for domestic purposes.

**Exception:** In areas where the records or data indicate that the groundwaters are grossly degraded, the ten (10) foot (3048 mm) separation requirement may be reduced by the Authority Having Jurisdiction.

The applicant shall supply evidence of groundwater depth to the satisfaction of the Authority Having Jurisdiction.

- (5) Leaching chambers shall be sized on the bottom absorption area (nominal unit width) in square feet. The required area shall be calculated using Table K-4 with a 0.70 multiplier.

## K 4 Percolation Test.

- (A) Wherever practicable, disposal field and seepage pit sizes shall be computed from Table K-4. Seepage

pit sizes shall be computed by percolation tests unless use of Table K-4 is approved by the Authority Having Jurisdiction.

**(B)** In order to determine the absorption qualities of seepage pits and of questionable soils other than those listed in Table K-4, the proposed site shall be subjected to percolation tests acceptable to the Authority Having Jurisdiction.

**(C)** When a percolation test is required, no private disposal system shall be permitted to serve a building if that test shows the absorption capacity of the soil is less than 0.83 gallons per square foot (33.8 L/m<sup>2</sup>) or more than 5.12 gallons per square foot (208 L/m<sup>2</sup>) of leaching area per 24 hours. If the percolation test shows an absorption rate greater than 5.12 gallons per square foot (208 L/m<sup>2</sup>) per 24 hours, a private disposal system may be permitted if the site does not overlie ground waters protected for drinking water supplies, a minimum thickness of two (2) feet (610 mm) of the native soil below the entire proposed system is replaced by loamy sand, and the system design is based on percolation tests made in the loamy sand.

#### **K 5 Septic Tank Construction.**

**(A)** Plans for all septic tanks shall be submitted to the Authority Having Jurisdiction for approval. Such plans shall show all dimensions, reinforcing, structural calculations, and such other pertinent data as may be required.

**(B)** Septic tank design shall be such as to produce a clarified effluent consistent with accepted standards and shall provide adequate space for sludge and scum accumulations.

**(C)** Septic tanks shall be constructed of solid durable materials not subject to excessive corrosion or decay and shall be watertight.

**(D)** Septic tanks shall have a minimum of two (2) compartments. The inlet compartment of any septic tank shall be not less than two-thirds (2/3) of the total capacity of the tank, nor less than five hundred (500) gallons (2.0 m<sup>3</sup>) liquid capacity, and shall be at least three (3) feet (914 mm) in width and five (5) feet (1524 mm) in length. Liquid depth shall be not less than two (2) feet (610 mm) and six (6) inches (152 mm) nor more than six (6) feet (1829 mm). The secondary compartment of any septic tank shall have a minimum capacity of two hundred fifty (250) gallons (1.0 m<sup>3</sup>) and a maximum capacity of one-

third (1/3) of the total capacity of such tank. In septic tanks having over a fifteen hundred (1500) gallon (6.0 m<sup>3</sup>) capacity, the secondary compartment may be not less than five (5) feet (1524) in length.

**(E)** Access to each septic tank shall be provided by at least two (2) manholes twenty (20) inches (508 mm) in minimum dimension or by an equivalent removable cover slab. One access manhole shall be located over the inlet and one (1) access manhole shall be located over the outlet. Wherever a first compartment exceeds twelve (12) feet (3658 mm) in length, an additional manhole shall be provided over the baffle wall.

**(F)** The inlet and outlet pipe openings shall be not in size than the connecting sewer pipe. The vertical leg of round inlet and outlet fittings shall not be less in size than the connecting sewer pipe nor less than four (4) inches (102 mm). A baffle-type fitting shall have the equivalent cross-sectional area of the connecting sewer pipe and not less than a four (4) inch (100 mm) horizontal dimension when measured at the inlet and outlet pipe inverts.

**(G)** The inlet and outlet pipe or baffle shall extend four (4) inches (100 mm) above and at least twelve (12) inches (305 mm) below the water surface. The invert of the inlet pipe shall be at a level not less than two (2) inches (51 mm) above the invert of the outlet pipe.

**(H)** Inlet and outlet pipe fittings or baffles and compartment partitions shall have a free vent area equal to the required cross-sectional area of the house sewer or private sewer discharging therein to provide free ventilation above the water surface from the disposal field or seepage pit through the septic tank, house sewer, and stack to the outer air.

**(I)** The side walls shall extend at least nine (9) inches (229 mm) above the liquid depth. The cover of the septic tank shall be at least two (2) inches (51 mm) above the back vent openings.

**(J)** Partitions or baffles between compartments shall be of solid, durable material and shall extend at least four (4) inches (102 mm) above the liquid level. An inverted fitting equivalent in size to the tank inlet, but in no case less than four (4) inches (102 mm) in size, shall be installed in the inlet compartment side of the baffle with the bottom of the fitting placed midway in the depth of the liquid. Wooden baffles are prohibited.

**(K)** Each such tank shall be structurally designed to withstand all anticipated earth or other loads. All septic tank covers shall be capable of supporting an earth load of not less than three hundred (300) pounds per square foot (14.4 kPa) when the maximum coverage does not exceed three (3) feet (914 mm). **(See TIA on page vii)**

**(L)** Septic tanks installed under concrete or blacktop paving shall have the required manholes accessible by extending the manhole openings to grade in a manner acceptable to the Authority Having Jurisdiction.

**(M) Materials.**

**(1) Concrete Septic Tanks.**

All materials used in constructing a septic tank shall be in accordance with applicable standards in Chapter 14, Table 14-1.

**(2) Steel Septic Tanks.**

The minimum wall thickness of any steel septic tank shall be No. 12 U.S. gauge (0.109) (2.8 mm), and each such tank shall be protected from corrosion both externally and internally by an approved bituminous coating or by other acceptable means.

**(3) Alternate Materials.**

(i) Septic tanks constructed of alternate materials may be approved by the Authority Having Jurisdiction when complying with approved applicable standards.

(ii) Wooden septic tanks are prohibited.

**(N) Prefabricated Septic Tanks.**

(1) Manufactured or prefabricated septic tanks shall comply with all approved applicable standards and be approved by the Authority Having Jurisdiction.

(2) Independent laboratory tests and engineering calculations certifying the tank capacity and structural stability shall be provided as required by the Authority Having Jurisdiction.

**K 6 Disposal Fields.**

**(A)** Distribution lines shall be constructed of clay tile laid with open joints, perforated clay pipe, perforated bituminous fiber pipe, perforated high-density polyethylene pipe, perforated ABS pipe, perforated PVC pipe, or other approved materials, provided that sufficient openings are available for distribution of the effluent into the trench area.

**(B)** Before placing filter material or drain lines in a prepared excavation, all smeared or compacted surfaces shall be removed from trenches by raking to a depth of one (1) inch (25.4 mm) and the loose material removed. Clean stone, gravel, slag, or similar filter material acceptable to the Authority Having Jurisdiction, varying in size from three fourths (3/4) inch to two and one-half (2-1/2) inches (19.1 mm to 64 mm) shall be placed in the trench to the depth and grade required by this section. Drain pipe shall be placed on filter material in an approved manner. The drain lines shall then be covered with filter material to the minimum depth required by this section and this material covered with untreated building paper, straw, or similar porous material to prevent closure of voids with earth backfill. No earth backfill shall be placed over the filter material cover until after inspection and acceptance.

**Exception:** Listed or approved plastic leaching chambers may be used in lieu of pipe and filter material. Chamber installations shall follow the rules for disposal fields, where applicable, and shall conform to manufacturer's installation instructions.

**(C)** A grade board staked in the trench to the depth of filter material shall be utilized when distribution line is constructed with drain tile or a flexible pipe material which will not maintain alignment without continuous support.

**(D)** When seepage pits are used in combination with disposal fields, the filter material in the trenches shall terminate at least five (5) feet (1524 mm) from the pit excavation and the line extending from such points to the seepage pit shall be approved pipe with watertight joints.

**(E)** Where two (2) or more drain lines are installed, an approved distribution box of sufficient size to receive lateral lines shall be installed at the head of each disposal field. The inverts of all outlets shall be level, and the invert of the inlet shall be at least one (1) inch (25.4 mm) above the outlets. Distribution boxes shall be designed to ensure equal flow and shall be installed on a level concrete slab in natural or compacted soil.

Distribution boxes shall be coated on the inside with a bituminous coating or other approved method acceptable to the Authority Having Jurisdiction.

**(F)** All laterals from a distribution box to the disposal field shall be approved pipe with watertight joints. Multiple disposal field laterals, wherever practicable, shall be of uniform length.

	Minimum	Maximum
Number of drain lines per field	1	—
Length of each line	—	100 ft. (30480 mm)
Bottom width of trench	18 in. (457 mm)	36 in. (914 mm)
Spacing of lines, center-to-center	6 ft. (1829 mm)	—
Depth of earth cover of lines [preferred —18 in. (457 mm)]	12 in. (305 mm)	—
Grade of lines	level	3 in./100 ft. (25 mm/m)
Filter material under drain lines	12 in. (305 mm)	—
Filter material over drain lines	2 in. (51 mm)	—

(G) Connections between a septic tank and a distribution box shall be laid with approved pipe with watertight joints on natural ground or compacted fill.

(H) When the quantity of sewage exceeds the amount that can be disposed in five hundred (500) lineal feet (152.4 m) of leach line, a dosing tank shall be used. Dosing tanks shall be equipped with an automatic siphon or pump which discharges the tank once every three (3) or four (4) hours. The tank shall have a capacity equal to sixty (60) to seventy-five (75) percent of the interior capacity of the pipe to be dosed at one time. Where the total length of pipe exceeds one thousand (1000) lineal feet (304.8 m), the dosing tank shall be provided with two (2) siphons or pumps dosing alternately and each serving one-half (1/2) of the leach field.

(I) Disposal fields shall be constructed as follows:  
(See chart above.)

Minimum spacing between trenches or leaching beds shall be four (4) feet (1219 mm) plus two (2) feet (610 mm) for each additional foot (305 mm) of depth in excess of one (1) foot (305 mm) below the bottom of the drain line. Distribution drain lines in leaching beds shall not be more than six (6) feet (1829 mm) apart on centers, and no part of the perimeter of the leaching bed shall be more than three (3) feet (914 mm) from a distribution drain line. Disposal fields, trenches, and leaching beds shall not be paved over or covered by concrete or any material that can reduce or inhibit any possible evaporation of sewer effluent.

(J) When necessary on sloping ground to prevent excessive line slope, leach lines or leach beds shall be stepped. The lines between each horizontal section shall be made with watertight joints and shall be designed so each horizontal leaching trench or bed shall be utilized to the maximum capacity before the

effluent shall pass to the next lower leach line or bed. The lines between each horizontal leaching section shall be made with approved watertight joints and installed on natural or unfilled ground.

**K 7 Seepage Pits.**

(A) The capacity of seepage pits shall be based on the quantity of liquid waste discharging thereto and on the character and porosity of the surrounding soil and shall conform to Section K 3 of this appendix.

(B) Multiple seepage pit installations shall be served through an approved distribution box or be connected in series by means of a watertight connection laid on undistributed or compacted soil; the outlet from the pit shall have an approved vented leg fitting extending at least twelve (12) inches (305 mm) below the inlet fitting.

(C) Each seepage pit shall be circular in shape and shall have an excavated diameter of not less than four (4) feet (1219 mm). Each such pit shall be lined with approved-type whole new hard-burned clay brick, concrete brick, concrete circular-type cesspool blocks, or other approved materials. Approval shall be obtained prior to construction for any pit having an excavated diameter greater than six (6) feet (1829 mm).

(D) The lining in every seepage pit shall be laid on a firm foundation. Lining materials shall be placed tight together and laid with joints staggered. Except in the case of approved type pre-cast concrete circular sections, no brick or block shall be greater in height than its width and shall be laid flat to form at least a four (4) inch (102 mm) wall. Brick or block greater than twelve (12) inches (305 mm) in length shall have chamfered matching ends and be scored to provide for seepage. Excavation voids behind the brick, block, or concrete liner shall have a minimum

of six (6) inches (152 mm) of clean three-fourths (3/4) inch (19.1 mm) gravel or rock.

**(E)** All brick or block used in seepage pit construction shall have a minimum compressive strength of twenty-five hundred (2500) pounds per square inch (17,237 kPa).

**(F)** Each seepage pit shall have a minimum sidewall (not including the arch) of ten (10) feet (3048 mm) below the inlet.

**(G)** The arch or dome of any seepage pit may be constructed in one of three ways:

(1) Approved-type hard-burned clay brick or solid concrete brick or block laid in cement mortar.

(2) Approved brick or block laid dry.

In both of the above methods, an approved cement mortar covering of at least two (2) inches (51 mm) in thickness shall be applied, said covering to extend at least six (6) inches (152 mm) beyond the sidewalls of the pit.

(3) Approved-type one or two-piece reinforced concrete slab of twenty-five hundred (2500) pounds per square inch (17237 kPa) minimum compressive strength, not less than five (5) inches (127 mm) thick and designed to support an earth load of not less than four hundred (400) pounds per square foot (19.2 kPa). Each such cover shall be provided with a nine (9) inch (229 mm) minimum inspection hole with plug or cover and shall be coated on the underside with an approved bituminous or other nonpermeable protective compound.

**(H)** The top of the arch or cover must be at least eighteen (18) inches (457 mm) but not more than four (4) feet (1219 mm) below the surface of the ground.

**(I)** An approved vented inlet fitting shall be provided in every seepage pit so arranged as to prevent the inflow from damaging the sidewall.

**Exception:** When using a one-or two-piece concrete slab cover inlet, fitting may be a one-fourth (1/4) bend fitting discharging through an opening in the top of the slab cover. On multiple seepage pit installations, the outlet fittings shall be per Section K 7(B) of this appendix.

### **K 8 Cesspools.**

**(A)** A cesspool shall be considered only as a

temporary expedient pending the construction of a public sewer; as an overflow facility when installed in conjunction with an existing cesspool; or as a means of sewage disposal for limited, minor, or temporary uses when first approved by the Authority Having Jurisdiction.

**(B)** Where it is established that a public sewer system will be available in less than two (2) years and soil and ground water conditions are favorable to cesspool disposal, cesspools without septic tanks may be installed for single-family dwellings or for other limited uses when first approved by the Authority Having Jurisdiction.

**(C)** Each cesspool, when permitted, shall conform to the construction requirements set forth in Section K 7 of this appendix for seepage pits and shall have a minimum sidewall (not including arch) of twenty (20) feet (6096 mm) below the inlet, provided, however, that when a strata of gravel or equally pervious material of four (4) feet (1219 mm) in thickness is found, the depth of such sidewall need not be more than ten (10) feet (3048 mm) below the inlet.

**(D)** When overflow cesspools or seepage pits are added to existing installations, the effluent shall leave the existing pit through an approved vented leg extending at least twelve (12) inches (305 mm) downward into such existing pit and having its outlet flow line at least six (6) inches (152 mm) below the inlet. All pipe between pits shall be laid with approved watertight joints.

### **K 9 Commercial or Industrial Special Liquid-Waste Disposal.**

**(A)** When liquid wastes contain excessive amounts of grease, garbage, flammable wastes, sand, or other ingredients which may affect the operation of a private sewage disposal system, an interceptor for such wastes shall be installed.

**(B)** Installation of such interceptors shall comply with Section 1009.0 of this code and their location shall be in accordance with Table K-1 of this appendix.

**(C)** Sampling box shall be installed when required by the Authority Having Jurisdiction.

**(D)** Interceptors shall be of approved design and be of not less than two (2) compartments. Structural

**Grease and Garbage, Commercial Kitchens**

$$\text{Number of meals per peak hour} \times \text{Waste flow rate} \times \text{Retention time} \times \text{Storage factor} = \text{Interceptor size (liquid capacity)}$$

**Sand-Silt Oil, Auto Washers**

$$\text{Number of vehicles per hour} \times \text{Waste flow rate} \times \text{Retention time} \times \text{Storage factor} = \text{Interceptor size (liquid capacity)}$$

**Silt-Lint Grease, Laundries, Laundromats**

$$\text{Number of machines} \times \text{2 cycles per hour} \times \text{Waste flow rate} \times \text{Retention time} \times \text{Storage Factor} = \text{Interceptor size (liquid capacity)}$$

**Waste Flow Rate**

See Table K-3 of this appendix for estimated flow rates.

**Retention Times**

Commercial kitchen waste:

Dishwasher and/or disposal.....2.5 hours

Single service kitchen:

Single serving with disposal.....1.5 hours

Sand-silt oil .....2.0 hours

Lint-silt (laundry) .....2.0 hours

**Storage Factors**

Fully equipped commercial kitchen.....8 h. operation: 1

16 h. operation: 2

24 h. operation: 3

Single service kitchen .....1.5

Auto washers .....self-serve: 1.5

employee operated: 2

Laundries, laundromats .....1.5 (allows for rock filter)

requirements shall be in compliance with the applicable subparts of Section K 5 of this appendix.

**(E)** Interceptors shall be located as close to the source as possible and be accessible for servicing. All necessary manholes for servicing shall be at grade level and be gastight.

**(F)** Waste discharge from interceptors may be connected to a septic tank or other primary system or be disposed into a separate disposal system.

**(G) Recommended Design Criteria.** (Formula may be adapted to other types of occupancies with similar wastes.) See charts on this page.

(1) Applicable provision of Section 103.5 of this code and this appendix shall be complied with. Plans may be required per Section 101.3 of this code.

(2) System components shall be properly identified as to manufacturer. Septic tanks or other primary systems shall have the rated capacity permanently marked on the unit.

(3) Septic tanks or other primary systems shall be installed on dry, level, well-compacted soil.

(4) If design is predicated on soil tests, the system shall be installed at the same location and depth as the tested area.

**(B) Testing.**

(1) Septic tanks or other primary components shall be filled with water to flow line prior

**K 10 Inspection and Testing.**

**(A) Inspection.**

to requesting inspection. All seams or joints shall be left exposed (except the bottom), and the tank shall remain watertight.

- (2) A flow test shall be performed through the system to the point of effluent disposal. All lines and components shall be watertight. Capacities, required air space, and fittings shall be in accordance with the provisions set forth in this appendix.

### K 11 Abandoned Sewers and Sewage Disposal Facilities.

(A) Every abandoned building (house) sewer, or part thereof, shall be plugged or capped in an approved manner within five (5) feet (1524 mm) of the property line.

(B) Every cesspool, septic tank, and seepage pit which has been abandoned or has been discontinued otherwise from further use or to which no waste or soil pipe from a plumbing fixture is connected shall have the sewage removed therefrom and be completely filled with the earth, sand, gravel, concrete, or other approved material.

**TABLE K-1**

Location of Sewage Disposal System

Minimum Horizontal Distance In Clear Required From:	Building Sewer	Septic Tank	Disposal Field	Seepage Pit or Cesspool
Buildings or structures <sup>1</sup>	2 feet (610 mm)	5 feet (1524 mm)	8 feet (2438 mm)	8 feet (2438 mm)
Property line adjoining private property	Clear <sup>2</sup>	5 feet (1524 mm)	5 feet (1524 mm)	8 feet (2438 mm)
Water supply wells	50 feet <sup>3</sup> (15240 mm)	50 feet (15240 mm)	100 feet (30.5 m)	150 feet (45.7 m)
Streams*	50 feet (15240 mm)	50 feet (15240 mm)	50 feet <sup>7</sup> (15240 mm) <sup>7</sup>	100 feet <sup>7</sup> (30.5 m) <sup>7</sup>
Trees	–	10 feet (3048 mm)	–	10 feet (3048 mm)
Seepage pits or cesspools	–	5 feet (1524 mm)	5 feet (1524 mm)	12 feet (3658 mm)
Disposal field	–	5 feet (1524 mm)	4 feet <sup>4</sup> (1219 mm)	5 feet (1524 mm)
On site domestic water service line	1 foot <sup>5</sup> (305 mm)	5 feet (1524 mm)	5 feet (1524 mm)	5 feet (1524 mm)
Distribution box	–	–	5 feet (1524 mm)	5 feet (1524 mm)
Pressure public water main	10 feet <sup>6</sup> (3048 mm)	10 feet (3048 mm)	10 feet (3048 mm)	10 feet (3048 mm)

**Note:**

When disposal fields and/or seepage pits are installed in sloping ground, the minimum horizontal distance between any part of the leaching system and ground surface shall be fifteen (15) feet (4572 mm).

<sup>1</sup> Including porches and steps, whether covered or uncovered, breezeways, roofed porte cocheres, roofed patios, carports, covered walks, covered driveways, and similar structures or appurtenances.

<sup>2</sup> See also Section 313.3 of the Uniform Plumbing Code.

<sup>3</sup> All drainage piping shall clear domestic water supply wells by at least fifty (50) feet (15,240 mm). This distance may be reduced to not less than twenty-five (25) feet (7620 mm) when the drainage piping is constructed of materials approved for use within a building.

<sup>4</sup> Plus two (2) feet (610 mm) for each additional one (1) foot (305 mm) of depth in excess of one (1) foot (305 mm) below the bottom of the drain line. (See also Section K 6.)

<sup>5</sup> See Section 720.0 of the Uniform Plumbing Code.

<sup>6</sup> For parallel construction – For crossings, approval by the Health Department shall be required.

<sup>7</sup> These minimum clear horizontal distances shall also apply between disposal field, seepage pits, and the ocean mean higher high tide line.

\*See TIA on page Viii

**TABLE K-2**  
Capacity of Septic Tanks\*

Single-Family Dwellings – Number of Bedrooms	Multiple Dwelling Units or Apartments – One Bedroom Each	Other Uses: Maximum Fixture Units Served per Table 7-3	Minimum Septic Tank Capacity in	
			Gallons	(Liters)
1 or 2		15	750	(2838)
3		20	1000	(3785)
4	2 units	25	1200	(4542)
5 or 6	3	33	1500	(5678)
	4	45	2000	(7570)
	5	55	2250	(8516)
	6	60	2500	(9463)
	7	70	2750	(10,409)
	8	80	3000	(11,355)
	9	90	3250	(12,301)
	10	100	3500	(13,248)

**\*Note:**

Extra bedroom, 150 gallons (568 liters) each.

Extra dwelling units over 10, 250 gallons (946 liters) each.

Extra fixture units over 100, 25 gallons (95 liters) per fixture unit.

Septic tank sizes in this table include sludge storage capacity and the connection of domestic food waste disposal units without further volume increase.

**TABLE K-3**

Estimated Waste/Sewage Flow Rates

Because of the many variables encountered, it is not possible to set absolute values for waste/sewage flow rates for all situations. The designer should evaluate each situation and, if figures in this table need modification, they should be made with the concurrence of the Authority Having Jurisdiction.

Type of Occupancy	Gallons (liters) Per Day
1. Airports	15 (56.8) per employee 5 (18.9) per passenger
2. Auto washers .....	Check with equipment manufacturer
3. Bowling alleys (snack bar only) .....	75 (283.9) per lane
4. Camps:	
Campground with central comfort station.....	35 (132.5) per person
Campground with flush toilets, no showers.....	25 (94.6) per person
Day camps (no meals served) .....	15 (56.8) per person
Summer and seasonal .....	50 (189.3) per person
5. Churches (Sanctuary) .....	5 (18.9) per seat
with kitchen waste .....	7 (26.5) per seat
6. Dance halls .....	5 (18.9) per person
7. Factories	
No showers.....	25 (94.6) per employee
With showers.....	35 (132.5) per employee
Cafeteria, add .....	5 (18.9) per employee
8. Hospitals .....	250 (946.3) per bed
Kitchen waste only .....	25 (94.6) per bed
Laundry waste only .....	40 (151.4) per bed
9. Hotels (no kitchen waste) .....	60 (227.1) per bed (2 person)



TABLE K-3 (Continued)

Type of Occupancy	Gallons (liters) Per Day
10. Institutions (Resident) .....	75 (283.9) per person
Nursing home.....	125 (473.1) per person
Rest home.....	125 (473.1) per person
11. Laundries, self-service	
(minimum 10 hours per day).....	50 (189.3) per wash cycle
Commercial.....	Per manufacturer's specifications
12. Motel	50 (189.3) per bed space
with kitchen.....	60 (227.1) per bed space
13. Offices	20 (75.7) per employee
14. Parks, mobile homes .....	250 (946.3) per space
picnic parks (toilets only) .....	20 (75.7) per parking space
recreational vehicles –	
without water hook-up.....	75 (283.9) per space
with water and sewer hook-up .....	100 (378.5) per space
15. Restaurants – cafeterias.....	20 (75.7) per employee
toilet.....	7 (26.5) per customer
kitchen waste.....	6 (22.7) per meal
add for garbage disposal.....	1 (3.8) per meal
add for cocktail lounge .....	2 (7.6) per customer
kitchen waste – Disposable service .....	2 (7.6) per meal
16. Schools – Staff and office .....	20 (75.7) per person
Elementary students .....	15 (56.8) per person
Intermediate and high.....	20 (75.7) per student
with gym and showers, add .....	5 (18.9) per student
with cafeteria, add.....	3 (11.4) per student
Boarding, total waste.....	100 (378.5) per person
17. Service station, toilets.....	1000 (3785) for 1st bay
	500 (1892.5) for each additional bay
18. Stores	20 (75.7) per employee
public restrooms, add.....	1 per 10 sq. ft. (4.1/m <sup>2</sup> ) of floor space
19. Swimming pools, public.....	10 (37.9) per person
20. Theaters, auditoriums.....	5 (18.9) per seat
drive-in.....	10 (37.9) per space

(a) **Recommended Design Criteria.** Sewage disposal systems sized using the estimated waste/sewage flow rates should be calculated as follows:

- (1) Waste/sewage flow, up to 1500 gallons/day (5677.5 L/day)  
Flow x 1.5 = septic tank size
- (2) Waste/sewage flow, over 1500 gallons/day (5677.5 L/day)  
Flow x 0.75 + 1125 = septic tank size
- (3) Secondary system shall be sized for total flow per 24 hours.

(b) Also see Section K 2 of this appendix.

**TABLE K-4**  
Design Criteria of Five Typical Soils

Type of Soil	Required sq. ft. of leaching area/ 100 gal. (m <sup>2</sup> /L)	Maximum absorption capacity in gals./sq. ft. of leaching area for a 24 hr. period (L/m <sup>2</sup> )
Coarse sand or gravel	20 (0.005)	5.0 (203.7)
Fine sand	25 (0.006)	4.0 (162.9)
Sandy loam or sandy clay	40 (0.010)	2.5 (101.8)
Clay with considerable sand or gravel	90 (0.022)	1.1 (44.8)
Clay with small amount of sand or gravel	120 (0.030)	0.8 (32.6)

**TABLE K-5**

Required Square Feet of Leaching Area/100 gal. Septic Tank Capacity (m <sup>2</sup> /L)		Maximum Septic Tank Size Allowable	
		Gallons	(liters)
20-25	(0.005-0.006)	7500	(28,387.5)
40	(0.010)	5000	(18,925.0)
90	(0.022)	3500	(13,247.5)
120	(0.030)	3000	(11,355.0)

(C) The top cover or arch over the cesspool, septic tank, or seepage pit shall be removed before filling, and the filling shall not extend above the top of the vertical portions of the sidewalls or above the level of any outlet pipe until inspection has been called and the cesspool, septic tank, or seepage pit has been inspected. After such inspection, the cesspool, septic tank, or seepage pit shall be filled to the level of the top of the ground.

(D) No person owning or controlling any cesspool, septic tank, or seepage pit on the premises of such person or in that portion of any public street, alley, or other public property abutting such premises shall fail, refuse, or neglect to comply with the provisions of this section or upon receipt of notice so to comply with the department having jurisdiction.

(E) Where disposal facilities are abandoned consequent to connecting any premises with the public sewer, the permittee making the connection shall fill all abandoned facilities as required by the Authority Having Jurisdiction within thirty (30) days from the time of connecting to the public sewer.

#### **K 12 Drawings and Specifications.**

The Authority Having Jurisdiction, Health Officer, or other department having jurisdiction may require any or all of the following information before a permit is issued for a private sewage disposal system or at any time during the construction thereof.

(A) Plot plan drawn to scale completely dimensioned, showing direction and approximate slope of surface, location of all present or proposed retaining walls, drainage channels, water supply lines or wells, paved areas and structures on the plot, number of bedrooms or plumbing fixtures in each structure, and location of the private sewage disposal system with relation to lot lines and structures.

(B) Details of construction necessary to assure compliance with the requirements of this appendix together with a full description of the complete installation including quality, kind, and grade of all materials, equipment, construction, workmanship, and methods of assembly and installation.

(C) A log of soil formations and groundwater levels as determined by test holes dug in close proximity to any proposed seepage pit or disposal field, together with a statement of water absorption characteristics

of the soil at proposed site, as determined by approved percolation tests.

# APPENDIX L

## ALTERNATE PLUMBING SYSTEMS

### L 1.0 Scope.

**L 1.1** The intent of this appendix is to provide clarification of procedures for the design and approval of engineered plumbing systems, alternate materials, and equipment not specifically covered in other parts of the code.

**L 1.2** The provisions of this appendix apply to the design, installation and inspection of an engineered plumbing system, alternate material, and equipment.

**L 1.3** The Authority Having Jurisdiction has the right to require descriptive details of an engineered plumbing system, alternate material, or equipment including pertinent technical data to be filed.

**L 1.4** Components, materials, and equipment must conform to standards and specifications listed in Table 14-1 of this code and other national consensus standards applicable to plumbing systems and materials.

**L 1.5** Where such standards and specifications are not available, alternate materials and equipment must be approved per the provisions of Section 301.2 of this code.

### L 2.0 Engineered Plumbing Systems.

**L 2.1 Definition.** *Engineered Plumbing System:* A system designed for a specific building project with drawings and specifications indicating plumbing materials to be installed, all as prepared by a person registered or licensed to perform plumbing design work.

**L 2.2 Inspection and Installation.** In other than one- and two-family dwellings, the designer of the system is to provide periodic inspection of the installation on a schedule found suitable to the Authority Having Jurisdiction. Prior to the final approval, the designer must verify to the Authority Having Jurisdiction that the installation is in compliance with the approved plans, specifications, and data and such amendments thereto. The designer must also certify to the Authority Having Jurisdiction that the installation is in compliance with the applicable engineered design criteria.

**L 2.3 Owner Information.** The designer of the system must provide the building owner with information concerning the system, considerations applicable for any subsequent modifications to the system, and maintenance requirements as applicable.

### L 3.0 Water Heat Exchangers.

**L 3.1** Heat exchangers used for heat transfer, heat recovery, or solar heating shall protect the potable water system from being contaminated by the heat transfer medium.

**L 3.2** Single-wall heat exchangers shall be permitted if they satisfy all of the following requirements:

- (1) The heat transfer medium is either potable water or contains essentially nontoxic transfer fluids having a toxicity rating or class of 1 (see Section 207.0).
- (2) The pressure of the heat transfer medium is maintained at less than the normal minimum operating pressure of the potable water system.

**Exception:** Steam complying with Section L 3.2 (1) above.

- (3) The equipment is permanently labeled to indicate that only additives recognized as safe by the FDA shall be used in the heat transfer medium.

**L 3.3** Other heat exchanger designs may be permitted where approved by the Authority Having Jurisdiction.

### L 4.0 Fixture Unit Values for Bathroom Groups.

**L 4.1** Tables L-1 and L-2 reflect the fixture unit loads for the fixtures in bathrooms as groups, rather than as individual fixtures. Such fixtures include water closets, lavatories, and bathtubs or showers. The tables reflect diversity in the use of fixtures within a bathroom and between multiple bathrooms.

**L 4.2** The listed water supply fixture unit values in Table L-1 reflect the load of entire bathroom groups on the cold-water service. Individual hot and cold water branch piping to the fixtures should be sized according to Chapter 6 and Appendix A.

**TABLE L-1**  
**Water Supply Fixture Units (WSFU) for Bathroom Groups**

	Individual Dwelling Units	Serving 3 or more Dwelling Units
<b>Bathroom Groups having 1.6 GPF Gravity-Tank Water Closets</b>		
Half-bath or Powder Room	3.5	2.5
1 Bathroom Group	5.0	3.5
1-1/2 Bathrooms	6.0	
2 Bathrooms	7.0	
2-1/2 Bathrooms	8.0	
3 Bathrooms	9.0	
Each Additional 1/2 Bath	0.5	
Each Additional Bathroom Group	1.0	
<b>Bathroom Groups having 1.6 GPF Pressure-Tank Water Closets</b>		
Half-bath or Powder Room	3.5	2.5
1 Bathroom Group	5.0	3.5
1-1/2 Bathrooms	6.0	
2 Bathrooms	7.0	
2-1/2 Bathrooms	8.0	
3 Bathrooms	9.0	
Each Additional 1/2 Bath	0.5	
Each Additional Bathroom Group	1.0	
<b>Bathroom Groups having 3.5 GPF Gravity-Tank Water Closets</b>		
Half-bath or Powder Room	4.0	3.0
1 Bathroom Group	6.0	5.0
1-1/2 Bathrooms	8.0	
2 Bathrooms	10.0	
2-1/2 Bathrooms	11.0	
3 Bathrooms	12.0	
Each Additional 1/2 Bath	0.5	
Each Additional Bathroom Group	1.0	
Bath Group (1.6 GPF Flushometer Valve)	6.0	4.0
Bath Group (3.5 GPF Flushometer Valve)	8.0	6.0
Kitchen Group (Sink and Dishwasher)	2.0	1.5
Laundry Group (Sink and Clothes Washer)	5.0	3.0

**Notes:**

1. A bathroom group, for the purposes of this table, consists of one water closet, up to two lavatories, and either one bathtub or one shower.
2. A half-bath or powder room, for the purposes of this table, consists of one water closet and one lavatory.

**L 4.3** The listed drainage fixture unit values in Table L-2 reflect the load of entire bathroom groups on the sanitary drainage system. Where fixtures within bathrooms connect to different branches of the drainage system, the fixture unit values for the individual fixtures shall be used, as listed in Table 7-3.

**L 5.0 Vacuum Drainage Systems.**

**L 5.1** Vacuum drainage systems shall be

considered engineered systems and shall comply with the requirements of L 1.0 and L 2.0.

**L 5.2** Vacuum drainage systems, including piping tank assemblies, vacuum pump assembly, and other components necessary for the proper function of the system shall be engineered and installed in accordance with the manufacturer's specifications. Plans and specifications shall be submitted to the Authority Having Jurisdiction for review and approval prior to installation.

**TABLE L-2**  
**Drainage Fixture Unit Values (DFU) for Bathroom Groups**

	Individual Dwelling Units	Serving 3 or more Dwelling Units
<b>Bathroom Groups having 1.6 GPF Gravity-Tank Water Closets</b>		
Half-bath or Powder Room	3.0	2.0
1 Bathroom Group	5.0	3.0
1-1/2 Bathrooms	6.0	
2 Bathrooms	7.0	
2-1/2 Bathrooms	8.0	
3 Bathrooms	9.0	
Each Additional 1/2 Bath	0.5	
Each Additional Bathroom Group	1.0	
<b>Bathroom Groups having 1.6 GPF Pressure-Tank Water Closets</b>		
Half-bath or Powder Room	3.5	2.5
1 Bathroom Group	5.5	3.5
1-1/2 Bathrooms	6.5	
2 Bathrooms	7.5	
2-1/2 Bathrooms	8.5	
3 Bathrooms	9.5	
Each Additional 1/2 Bath	0.5	
Each Additional Bathroom Group	1.0	
<b>Bathroom Groups having 3.5 GPF Gravity-Tank Water Closets</b>		
Half-bath or Powder Room	3.0	2.0
1 Bathroom Group	6.0	4.0
1-1/2 Bathrooms	8.0	
2 Bathrooms	10.0	
2-1/2 Bathrooms	11.0	
3 Bathrooms	12.0	
Each Additional 1/2 Bath	0.5	
Each Additional Bathroom	1.0	
Bath Group (1.6 GPF Flushometer Valve)	5.0	3.0
Bath Group (3.5 GPF Flushometer Valve)	6.0	4.0

**Notes:**

1. A bathroom group, for the purposes of this table, consists of not more than one water closet, up to two lavatories, and either one bathtub or one shower.
2. A half-bath or powder room, for the purposes of this table, consists of one water closet and one lavatory.

**L 5.3 Fixtures.** Fixtures used in vacuum drainage systems shall comply with L 1.4 and L 1.5.

**L 5.6 Traps and Cleanouts.** For gravity fixtures, traps and cleanouts shall be per approved plans.

**L 5.4 Drainage Load.** The pump discharge load from the collector tanks shall be in accordance with Chapter 7.

**L 6.0 Special Venting of Fixtures.**

**L 5.5 Water Supply Fixture Units.** Water supply fixture units shall be based on the values in Chapter 6. The load requirement of a vacuum-type water closet shall be determined per manufacturer's specification.

**L 6.1 Batteries of Fixtures (Battery Venting).**

**L 6.1.1** A maximum of eight (8) floor-outlet water closets, showers, bathtubs, or floor drains connected in battery on a horizontal branch drain shall be permitted to be battery vented. The drain from each fixture being battery vented shall connect

horizontally to the horizontal wet-vented drain branch. The horizontal wet-vented branch drain shall be considered as a vent extending from the downstream fixture drain connection to the most upstream fixture connection.

**L 6.1.2** Back-outlet water closets having carriers conforming to Section 704.1 shall be permitted to be battery-vented provided they connect horizontally to the horizontal wet-vented section.

**L 6.1.3** Trap arm lengths for fixtures shall not exceed those as indicated in Table 10-1.

**L 6.1.4** A battery vent shall be connected to the horizontal wet-vented branch drain between the two (2) most upstream fixture drains.

**L 6.1.5** The entire length of the wet-vented section of the horizontal branch drain shall be uniformly sized for the total drainage discharge connected thereto as per Table 7-5. The maximum slope of the horizontal drain shall be three-eighths (3/8) inch (10 mm) per foot (300 mm).

**L 6.1.6** A relief vent shall be provided on each wet-vented horizontal drain branch below the uppermost floor. The relief vent shall connect to the horizontal drain branch between the stack and the first upstream fixture drain.

**L 6.1.7** Battery vents and relief vent connections shall be taken off vertically from the top of the horizontal drain.

Battery vents and relief vents shall not be used as vertical wet vents.

**L 6.1.8** Lavatories and drinking fountains shall be permitted to connect horizontally to the horizontal wet-vented branch drain provided that they are located on the same floor as the battery-vented fixtures and each is provided with either an individual or common vent.

**L 6.1.9** Batteries of more than eight (8) battery vented fixtures shall have a separate battery vent for each group of eight (8) or less fixtures, and the horizontal branch drain in each group shall be sized for the total drainage into the branch, including all upstream branches and the fixtures within the particular group.

**L 6.1.10** All battery vents and relief vents shall be sized according to Section 904.0, but shall be not less than one-half (1/2) the area of the drain pipe that they serve and shall comply with Section 905.0

## **L 6.2 Single Bathroom or Single Toilet Room.**

**L 6.2.1** An individually vented lavatory in a single bathroom or single toilet room shall be permitted to serve as the wet vent for one (1) water closet and/or one (1) bathtub or shower stall, or one (1) water closet and/or one (1) bathtub/shower combination if all of the following conditions are met:

- (1) The wet vent, and the dry vent extending from the wet vent, shall be two (2) inch (50 mm) minimum pipe size.
- (2) The wet vent pipe opening shall not be below the weir of the trap that it serves. Vent sizing, grades, and connections shall comply with Sections 904.0 and 905.0.
- (3) The horizontal branch drain serving both the lavatory and the bathtub or shower stall shall be two (2) inch (50 mm) minimum pipe size.
- (4) The length of the trap arm from the bathtub or shower stall complies with the limits in Table 10-1.
- (5) The distance from the outlet of the water closet to the connection of the wet vent complies with the limits in Table 10-1.
- (6) The horizontal branch drain serving the lavatory and the bathtub or shower stall shall connect to the horizontal water closet branch above its centerline. When the bathroom or toilet room is the top-most load on a stack, the horizontal branch serving the lavatory and the bathtub or shower stall shall be permitted to connect to the stack below the water-closet branch.
- (7) No fixture other than those listed in L 6.2.1 shall discharge through a single bathroom or single toilet room wet-vented system.

## **L 6.3 Double Bathtubs, Bathtub/Shower Combinations, Shower Stalls, and Lavatories.**

Two (2) lavatories, each rated at 1.0 drainage fixture unit (DFU), and two (2) bathtubs, bathtub/shower combinations, or shower stalls, installed in adjacent bathrooms, shall be permitted to drain to a horizontal drain branch that is two (2) inch (50 mm) minimum pipe size, with a common vent for the lavatories and no individual vents for the bathtubs, bathtub/shower combinations, or shower stalls,

provided that the wet vent from the lavatories and their dry vent is two (2) inch (50 mm) minimum pipe size and the length of all trap arms comply with the limits in Table 10-1.

### **L 7.0 FOG (Fats, Oils, and Greases) Disposal Systems.**

#### **L 7.1 Purpose.**

The purpose of this section is to provide the necessary criteria for the sizing, application, and installation of FOG disposal systems designated as a pretreatment or discharge water quality compliance strategy.

#### **L 7.2 Scope.**

FOG disposal systems shall be considered engineered systems and shall comply with the requirements of L 1.0 and L 2.0.

#### **L 7.3 Components, Materials, and Equipment.**

FOG disposal systems, including all components, materials and equipment necessary for the proper function of the system, shall comply with L 1.4 and L 1.5.

#### **L 7.4 Sizing Application and Installation.**

FOG disposal systems shall be engineered, sized, and installed in accordance with the manufacturer's specifications and as specified in IAPMO PS118-2000, as listed in Chapter 14, Table 14-1 of this code.

#### **L 7.5 Performance.**

FOG Disposal Systems shall be tested and certified as described in IAPMO PS 118-2000, as listed in Chapter 14, Table 14-1 of this code, and other national consensus standards applicable to FOG disposal systems as discharging no more than 100 mg/L FOG.





# USEFUL TABLES

## Conversion Table

"The information contained in these tables are not part of this American National Standard (ANS) and have not been processed in accordance with ANSI's requirements for an ANS. As such, these tables may contain material that has not been subjected to public review or a consensus process. In addition, they do not contain requirements necessary for conformance to the standard."

MULTIPLY	BY	TO OBTAIN
Acres .....	43,560 .....	Square feet
Acre-feet .....	43,560 .....	Cubic feet
Acre-foot .....	325,851 .....	Gallons
Atmospheres .....	76.0 .....	Cm of mercury
Atmospheres .....	29.92 .....	Inches of mercury
Atmospheres .....	33.90 .....	Feet of water
Atmospheres .....	14.70 .....	Pounds/square inch
Btu/minute .....	12.96 .....	Foot-Pounds/second
Btu/minute .....	0.02356 .....	Horse power
Centimeters .....	0.3937 .....	Inches
Centimeters of mercury .....	0.01316 .....	Atmospheres
Centimeters of mercury .....	0.4461 .....	Feet of water
Centimeters of mercury .....	27.85 .....	Pounds/square feet
Centimeters of mercury .....	0.1934 .....	Pounds/square inch
Cubic feet.....	1728 .....	Cubic inches
Cubic feet.....	0.03704 .....	Cubic yards
Cubic feet.....	7.48052 .....	Gallons
Cubic feet.....	29.92 .....	Quarts (liquid)
Cubic feet/minute.....	472.0 .....	Cubic cms/second
Cubic feet/minute.....	0.1247 .....	Gallons/second
Cubic feet/minute.....	62.43 .....	Pounds of water/minute
Cubic feet/second .....	0.0646317 .....	Million gallons/day
Cubic feet/second .....	448.831 .....	Gallons/minute
Cubic yards .....	27 .....	Cubic feet
Cubic yards .....	202.0 .....	Gallons
Feet of water .....	0.02950 .....	Atmospheres
Feet of water .....	0.8826 .....	Inches of mercury
Feet of water .....	62.43 .....	Pounds/square feet
Feet of water .....	0.4335 .....	Pounds/square inch
Feet/minute .....	0.01667 .....	Feet/second
Feet/minute .....	0.01136 .....	Miles/hour
Feet/second .....	0.6818 .....	Miles/hour
Feet/second .....	0.01136 .....	Miles/minute
Gallons .....	3785 .....	Cubic centimeters
Gallons .....	0.1337 .....	Cubic feet

<b>MULTIPLY</b>	<b>BY</b>	<b>TO OBTAIN</b>
Gallons .....	.231 .....	Cubic inches
Gallons .....	4 .....	Quarts (liquid)
Gallons water .....	.83453 .....	Pounds of water
Gallons/minute .....	0.002228 .....	Cubic feet/second
Gallons/minute .....	.8.0208 .....	Cubic feet/hour
Gallons water/minute .....	6.0086 .....	Tons of water/24 hours
Inches .....	2.540 .....	Centimeters
Inches of mercury .....	0.03342 .....	Atmospheres
Inches of mercury .....	1.133 .....	Feet of water
Inches of mercury .....	0.4912 .....	Pounds/square inch
Inches of water .....	0.002458 .....	Atmospheres
Inches of water .....	0.07355 .....	Inches of mercury
Inches of water .....	5.202 .....	Pounds/square feet
Inches of water .....	0.03613 .....	Pounds/square inch
Liters .....	1000 .....	Cubic centimeters
Liters .....	61.02 .....	Cubic inches
Liters .....	0.2642 .....	Gallons
Miles .....	5280 .....	Feet
Miles/hour .....	.88 .....	Feet/minute
Miles/hour .....	1.467 .....	Feet/second
Millimeters .....	0.1 .....	Centimeters
Millimeters .....	0.03937 .....	Inches
Million gallon/day .....	1.54723 .....	Cubic feet/second
Pounds of water .....	0.01602 .....	Cubic feet
Pounds of water .....	27.68 .....	Cubic inches
Pounds of water .....	0.1198 .....	Gallons
Pounds/cubic inch .....	1728 .....	Pounds/cubic foot
Pounds/square foot .....	0.01602 .....	Feet of water
Pounds/square inch .....	0.06804 .....	Atmospheres
Pounds/square inch .....	2.307 .....	Feet of water
Pounds/square inch .....	2.036 .....	Inches of mercury
Quarts (dry) .....	67.20 .....	Cubic inches
Quarts (liquid) .....	57.75 .....	Cubic inches
Square feet .....	144 .....	Square inches
Square miles .....	640 .....	Acres
Square yards .....	9 .....	Square feet
Temperature (°C) + 273 .....	1 .....	Abs. temperature (°C)
Temperature (°C) + 17.28 .....	1.8 .....	Temperature (°F)
Temperature (°F) + 460 .....	1 .....	Abs. temperature (°F)
Temperature (°F) – 32 .....	5/9 .....	Temperature (°C)
Tons (short) .....	2000 .....	Pounds
Tons of water/24 hours .....	83.333 .....	Pounds water/hour
Tons of water/24 hours .....	0.16643 .....	Gallons/minute
Tons of water/24 hours .....	1.3349 .....	Cubic feet/hour

Areas and Circumference of Circles

Diameter		Circumference		Area	
Inches	mm	Inches	mm	Inches <sup>2</sup>	mm <sup>2</sup>
1/8	6	0.40	10	0.01227	8.0
1/4	8	0.79	20	0.04909	31.7
3/8	10	1.18	30	0.11045	71.3
1/2	15	1.57	40	0.19635	126.7
3/4	20	2.36	60	0.44179	285.0
1	25	3.14	80	0.7854	506.7
1-1/4	32	3.93	100	1.2272	791.7
1-1/2	40	4.71	120	1.7671	1140.1
2	50	6.28	160	3.1416	2026.8
2-1/2	65	7.85	200	4.9087	3166.9
3	80	9.43	240	7.0686	4560.4
4	100	12.55	320	12.566	8107.1
5	125	15.71	400	19.635	12,667.7
6	150	18.85	480	28.274	18,241.3
7	175	21.99	560	38.485	24,828.9
8	200	25.13	640	50.265	32,428.9
9	225	28.27	720	63.617	41,043.1
10	250	31.42	800	78.540	50,670.9

EQUAL PERIPHERIES

$S = 0.7854 D$   
 $D = 1.2732 S$

$S = 0.8862 D$   
 $D = 1.1284 S$   
 $S = 0.2821 C$

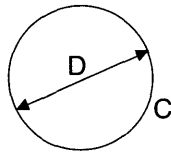

EQUAL AREAS

Area of square (S') =  
 1.2732 x area of circle

Area of square (S) =  
 0.6366 x area of circle

$C = \pi D = 2\pi R$

$C = 3.5446 \sqrt{\text{area}}$

$D = 0.3183 C = 2R$

$D = 1.1283 \sqrt{\text{area}}$

$\text{Area} = \pi R^2 = 0.7854 D^2$

$\text{Area} = 0.07958 C^2 = \frac{\pi D^2}{4}$

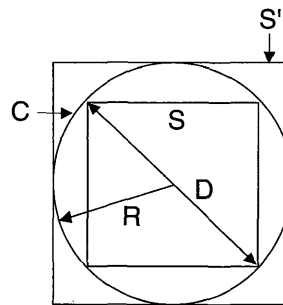

$\pi = 3.1416$

**Flow in Partly Filled (One-Half Full) Pipes  
(Based on Manning's Formula with  $n = .012$ )**

gpm x 6.31 = L/s  
ft/sec x .305 = m/s  
in. x 25.4 = mm

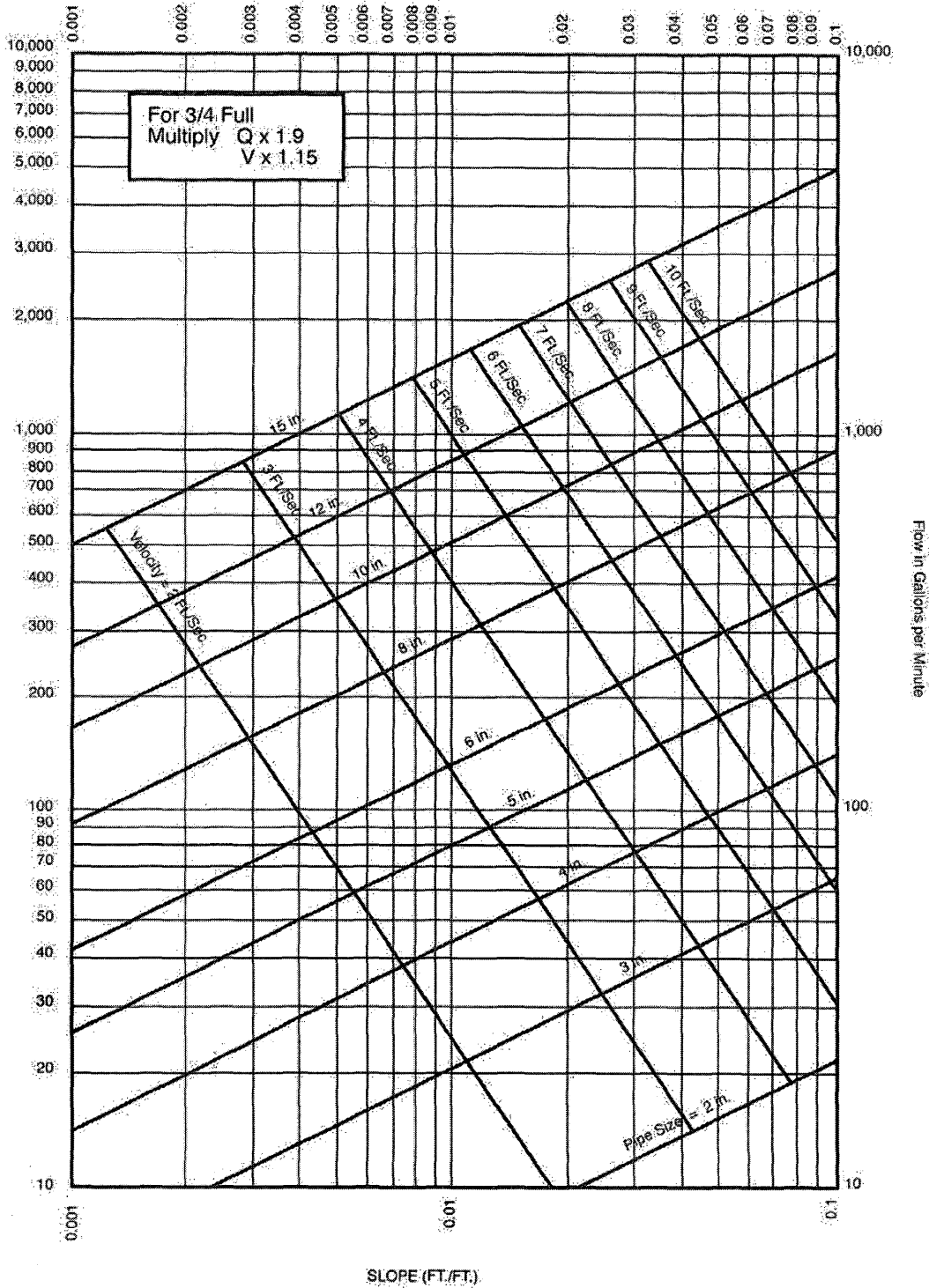

USEFUL TABLES

**Flow in Partly Filled (Full) Pipes**  
 (Based on Manning's Formula with  $n = .012$ )

gpm x 6.31 = L/s.  
 ft/sec x .305 = m/s.  
 in. x 25.4 = mm

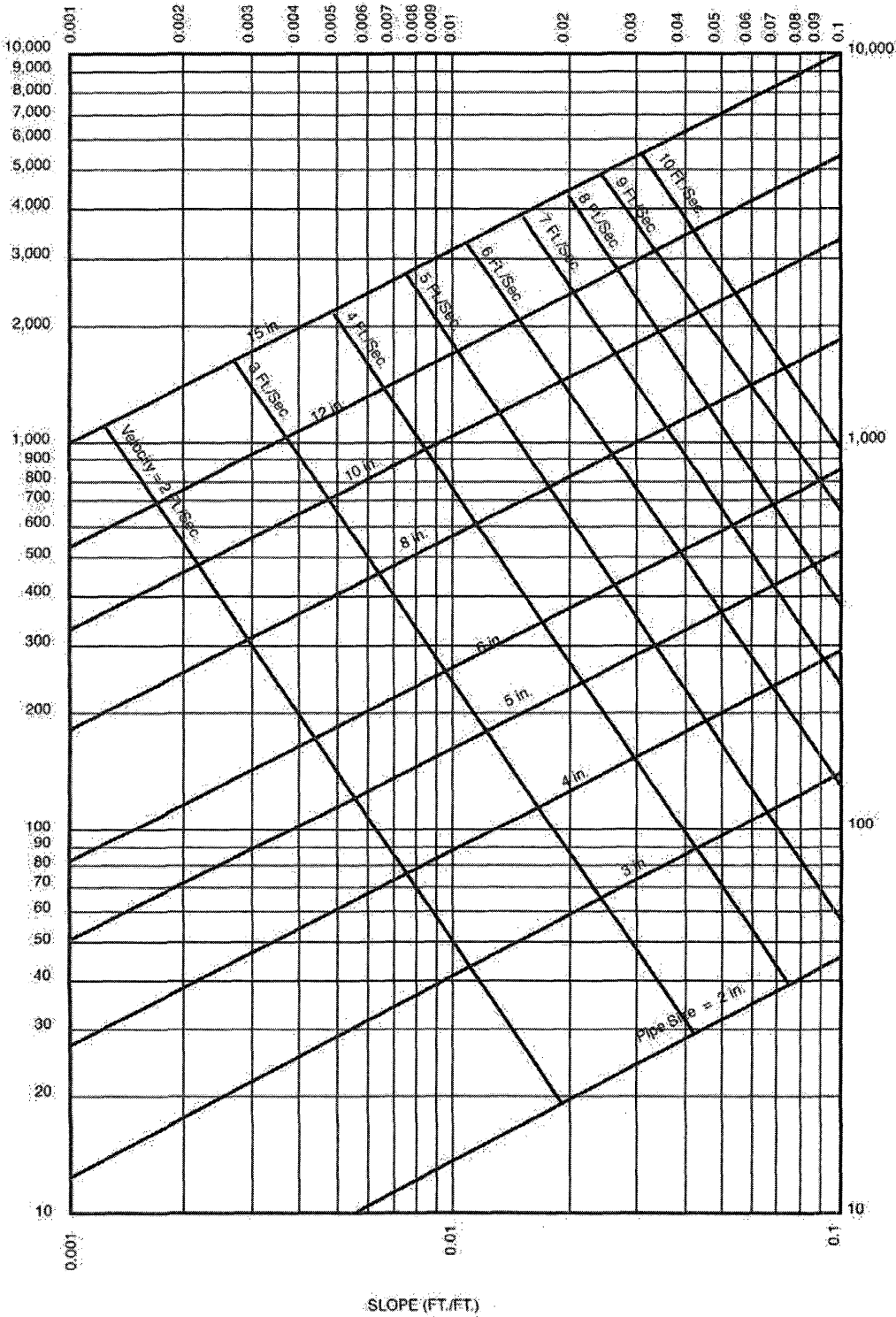

**METRIC SYSTEM****(INTERNATIONAL SYSTEM OF UNITS – SI)**

For the users of this Code, we are including a short explanation and some conversion tables to aid in the conversion of our familiar English units to the forthcoming SI units.

This is written with the Code users in mind, and will detail only those measurements used in everyday work and calculations. For the scientific units, we recommend the use of ANSI Z210.1, "Metric Practice Guide."

**GENERAL COMMENTS**

Our present system of measuring involves the three dimensions of force, length and time. The SI units involve mass, length, and time. The change of force to mass has meaning in scientific and engineering work, but for practical use in ordinary construction, we will show kilogram to pounds conversion values, although an exact conversion would be pounds force divided by the acceleration due to gravity to mass units.

In the same manner, the SI units for temperature expressed in Kelvins and based on absolute zero will be given as degrees Celsius, which is the more familiar and practical Centigrade degrees.

The SI system measures angles in radians where there are 2 pi radians in a circle, but using a 1.5708 bend to change from a vertical stack to a horizontal house drain is not as easy as calling out a 1/4 bend or an ell for water piping.

The foregoing notes are intended to show that in making conversions from one unit system to another, a little common sense must be used and the degree of accuracy needed to do the job at hand.

The following tables are set up using this approach and using the preferred SI units.

USEFUL TABLES

**METRIC SYSTEM  
(INTERNATIONAL SYSTEM OF UNITS – SI)**

<b>TO CONVERT</b>	<b>INTO</b>	<b>MULTIPLY BY</b>
Atmospheres	Cm of mercury	76.0
Btu	Joules	1,054.8
Btu/hour	Watts	0.2931
Btu/minute	Kilowatts	0.01757
Btu/minute	Watts	17.57
Centigrade	Fahrenheit	$(^{\circ}\text{C} \times 9/5) + 32^{\circ}$
Circumference	Radians	6.283
Cubic centimeters	Cubic inches	0.06102
Cubic feet	Cubic meters	0.02832
Cubic feet	Liters	28.32
Cubic feet/minute	Cubic cm/second	472.0
Cubic inches	Cubic cm	16.39
Cubic inches	Liters	0.01639
Cubic meters	Gallons (U.S. liquid)	264.2
Feet	Centimeters	30.48
Feet	Meters	0.3048
Feet	Millimeters	304.8
Feet of water	Kg/square cm	0.03048
Foot-Pounds	Joules	1.356
Foot-pounds/minute	Kilowatts	$2.260 \times 10^{-5}$
Foot-pounds/second	Kilowatts	$1.356 \times 10^{-3}$
Gallons	Liters	3.785
Horsepower	Watts	745.7
Horsepower-hours	Joules	$2.684 \times 10^6$
Horsepower-hours	Kilowatt-hours	0.7457
Joules	Btu	$9.480 \times 10^{-4}$
Joules	Foot-pounds	0.7376
Joules	Watt-hours	$2.778 \times 10^{-4}$
Kilograms	Pounds	2.205
Kilograms	Tons (short)	$1.102 \times 10^{-3}$
Kilometers	Miles	0.6214
Kilometers/hour	Miles/hour	0.6214
Kilowatts	Horsepower	1.341
Kilowatt-hours	Btu	3,413
Kilowatt-hours	Foot-pounds	$2.655 \times 10^6$
Kilowatt-hours	Joules	$3.6 \times 10^6$
Liters	Cubic feet	0.03531



**METRIC SYSTEM**  
**(INTERNATIONAL SYSTEM OF UNITS – SI)**  
**(Continued)**

<b>TO CONVERT</b>	<b>INTO</b>	<b>MULTIPLY BY</b>
Liters	Gallons (U.S. liquid)	0.2642
Meters	Feet	3.281
Meters	Inches	39.37
Meters	Yards	1.094
Meters/second	Feet/second	3.281
Meters/second	Miles/hr	2.237
Miles (statute)	Kilometers	1.609
Miles/hour	Meters/minute	26.82
Millimeters	Inches	0.03937
Ounces (fluid)	Liters	0.02957
Pints (liquid)	Cubic centimeters	473.2
Pounds	Kilograms	0.4536
PSI	Pascals	6,895
Quarts (liquid)	Liters	0.9463
Radians	Degrees	57.30
Square inches	Square millimeters	645.2
Square meters	Square inches	1,550
Square millimeters	Square inches	$1.550 \times 10^{-3}$
Watts	Btu/hour	3.4129
Watts	Btu/minute	0.05688
Watts	Foot-pounds/second	0.7378
Watts	Horsepower	$1.341 \times 10^{-3}$

When the plumbing industry, including plumbers, suppliers, and manufacturers, actually begins the metric conversion program, it will undoubtedly follow the guidelines of committees selected from all phases of the construction industry as set up under the American National Metric Council.

The final preferred units used will be those that apply to our industry and will be of the magnitude to simplify and ease job calculations and avoid confusion and ambiguity.

The conversion looks complex and confusing, but when the metric system was first proposed in France, an attempt was made to include a ten hour day, a ten day week, and ten months to the year, but cooler heads prevailed and our time still follows the sun and seasons. Likewise, assigning new units or numbers to the quantities we must work with cannot change the basic hydraulic principles that plumbers have worked with throughout history.

Information on conversion factors is provided by ANSI, the American National Metric Council, and the Division of Designatronics, Inc.

# INDEX

© 2003 International Association of Plumbing and Mechanical Officials. All rights reserved.

The copyright in this index is separate and distinct from the copyright in the document that it indexes. The licensing provisions set forth for the document are not applicable to this index. This index may not be reproduced in whole or in part by any means without the express written permission of IAPMO.

## - A -

Abandoned cesspools, grease interceptors, septic tanks, and seepage pits	.722.0, Appendix K
Absorption area, capacity of	Table K-4, Appendix K
Access panels	.203.0, 405.0, 415.0
Accessible, definition	.203.0
Accessibility of:	
Backwater valves	710.0, 1006.0
Chemical waste system	811.0
Cleanouts	707.0, 719.0
Fixtures for inspection, repairs, and cleaning	408.0
Floor drain traps	1006.0
Gas meters	1209.0
Grease traps or interceptors	1009.0, 1014.0, Appendix H
Industrial interceptors and separators	1009.0
Receptors	804.0
Regulator and relief valves	608.0
Septic tanks	Appendix K
Shutoff and control valves	605.0, 1211.0
Slip joints	405.0
Sump and receiving tanks	810.0
Valves, gas	1211.0
Valves, water	605.0
Water heaters	505.0
Acrylonitrile-butadiene-styrene (ABS)	203.0, 701.0, 707.1, 903.0
Additions	101.4.1, 301.0
Additives, packing, prohibited	705.1.5
Advance notice for inspections	103.5.4.1
Airbreak:	
Definition	.203.0
Required	.801.0
Airgap:	
Definition	.203.0
Required	.603.3, 801.1, 806.0, 807.0
Air intakes, vent termination near	906.0
Air tank, for sumps	710.0
Air tests:	
Gas piping system	1214.0
Water piping system	103.5.3.3
Alterations and repairs:	
Deviations allowed	101.4.1.1.1, 301.0
Gas piping	301.0, 1210.0
Sewage disposal	301.0
Water heaters	301.0
Water piping	301.0
Alternate materials	301.0, 403.0
Anchors and hangers	see Supports
Appliance:	
Connectors	1212.0, Tables 12-13 & 12-14
Gas, demand requirements	1216.0, Table 12-1
Indirect waste type	806.0-808.0
Application for permit	.103.2
Approval required:	
Appliances, fixtures	301.0, 407.0, 505.0, 508.0, 610.0
Backflow preventers	603.0
Ballcocks	603.4.2

Cesspool	Appendix K
Chemical waste system	811.0
Combination waste and vent system	910.0, Appendix B
Completed plumbing work	103.5.1
Devices	603.0
Flue, vents	510.2
Grease trap	1011.0
Indirect waste receptors	802.0
Industrial interceptors and separators	1009.0
Materials, specifications, standards	301.0, 707.0
Plans	101.3, 1014.0
Seepage pit	Appendix K
Septic tank and disposal system	Appendix K
Special fixtures	407.0
Vacuum breakers	603.0
Water heaters, gas	505.0
Water heaters, oil	506.0
Approved, general definition	203.0
Approved testing agency	203.0, 301.0
Area Drain, definition	203.0
Asbestos cement pipe joint	705.1.4
Aspirator, definition	203.0
Aspirators, protection	603.0
Attachment, vertical piping	314.0
Authority Having Jurisdiction	203.0
Authority to:	
Disconnect gas	1207.0
Render gas service	1206.0
Automatic:	
Clotheswasher stand pipe	804.0
Flushing tanks	409.0
Flush valves	409.0
Priming device, for floor drains	1007.0
Siphon, septic tank	Appendix K
Auto wash racks	1011.0

## - B -

Backfilling	315.0
Backflow	204.0, 603.0, 1002.0
Backflow connection	204.0, 603.0
Backflow preventer	see Cross-Connections, Back-Siphonage
Backing for fixtures	408.0
Backpressure backflow	204.0, 603.0
Back-siphonage	see Cross-Connections, Backflow Preventer
Back-siphonage of traps, protection	1002.0
Back-to-back fixtures	704.0
Backwater valve	204.0, 710.0
Ballcocks, approval required	603.0
Baptistries	407.0
Bathtub, prohibited type	406.0
Bell and spigot joints	705.1
Bell traps, prohibited	1004.0
Benching of trenches	315.0, 720.0
Blow off condensers	810.0
Boiler blowoff:	

## UNIFORM PLUMBING CODE

Definition .....	204.0
Prohibited discharge .....	810.0
Bolts, non-corrosive .....	408.0
Bowl wax or gaskets .....	316.3
Branch, definition .....	204.0
Branch, fixture, definition .....	204.0
Branch, horizontal, definition .....	204.0
Branch vent, definition .....	204.0
Brass connections, ground joint .....	705.3.3
Brass pipe .....	701.0, 604.0, 903.0, 1209.5.2.3
Brazing or welding joints .....	310.0, 316.1.7
Btu rating, gas appliances .....	1209.4.2
Building, definition .....	204.0
Building drain (sanitary)	
Definition .....	204.0
Size of .....	703.0
Building drain (storm), definition .....	204.0
Buildings over sewer .....	101.4.1.1
Building sewer .....	Chapter 7
Cleanouts .....	719.0
Combined, definition .....	204.0
Damage to .....	306.0
Definition .....	204.0
Distance from building and below ground .....	313.0, 720.0
Grade and support of .....	718.0
Location of .....	308.0, 313.0, 718.0, 721.0, Table 7-7
Material of .....	715.0, Table 14-1
Must be on same lot as buildings .....	308.0
Required .....	305.0, 713.0
Sanitary, definition .....	204.0
Size of .....	717.0
Storm, definition .....	204.0
Testing of .....	723.0
Water pipe in trench .....	720.0
Building sewers and drains, existing .....	101.4.1.1.2
Building subdrain, definition .....	204.0
Building supply, definition .....	204.0
Burned lead joints .....	705.1.3
Burred ends .....	310.3, 609.0, 701.0, 903.0, 1209.5.5
Bushings, solder .....	701.4.2, Table 7-2
- C -	
Capacity of:	
Disposal field .....	Appendix K
Seepage pits .....	Appendix K
Water closet tanks .....	402.0
Cast-iron soil pipe and fittings	
Joints and connections .....	705.3.2
Support of .....	314.0
Caulked joints .....	705.1
Caulking, waterproofing .....	408.0
Caulking ferrules .....	701.4, 705.3.3, Table 7-1
Cement mortar joints, prohibited .....	705.1.2
Certificate of Final Approval .....	103.5.6.3, 1205.0
Certification by:	
Backflow assembly testers .....	205.0, 603.3.2
Medical gas certifiers .....	1311.3
Medical gas installers .....	1311.3
Medical gas systems .....	1311.2
Pipe welder .....	225.0, Table 14-1
Cesspool: .....	Appendix K
Abandoned .....	722.0
Connections to sewer prohibited .....	714.0
Definition .....	205.0
Distance from lot line, building, surface .....	Table K-1
Must be on same lot as building .....	308.0
Change in direction of drainage piping .....	706.0
Change in direction of gas piping .....	1211.5
Check valves:	
In gas systems .....	1211.12.6
In water systems .....	608.3
Chemical toilet, prohibited .....	406.2
Chemical waste .....	205.0, 811.0
Clarifier .....	205.0, 1008.0-1013.0, Appendix H
Clay, vitrified .....	701.0
Joints and connections .....	705.3.1
Cleanout plugs or caps .....	707.1-3, 707.13, 707.14,
Cleanouts .....	707.0, 719.0
Clearance for:	
Water heaters .....	505.3.1, 505.3.2
Water heater vents .....	512.0
Clear water waste, definition .....	205.0
Clinic sink, definition .....	205.0
Closet bends, prohibited type .....	311.0
Maximum length .....	1002.0
Permitted .....	316.2
Closet rings .....	316.3, 316.3.2, 704.0, 704.4
Closet screw bolts .....	704.5
Clothes washer stand pipe .....	804.0
Code:	
Definition .....	205.0
Validity of .....	103.8
Combination fixture .....	1001.0
Combination waste and vent system .....	205.0, 910.0, Appendix B
Combustible material, definition .....	502.6
Combustion air, required .....	507.0
Common .....	205.0, 905.0
Common vent, gas .....	510.6.4
Compartments for:	
Toilets .....	408.0
Water heaters .....	505.0
Compression joints .....	316.1.5
Concealed slip joints .....	405.2
Concealing of work prohibited before inspection .....	103.5.1.1, 103.5.1.3, 1204.0
Condensers and sumps .....	810.0
Control, shutoff valves .....	605.0, 1211.0
Connection:	
At septic tank .....	Appendix K
Indirect waste piping .....	803.0
To plumbing system, required .....	304.0
To sewer, required .....	305.0, 713.0
Connector, gas .....	Tables 12-9, 12-10 & 12-14
Connector, vent .....	510.10, 510.11
Construction, existing .....	101.4.1.3
Contamination .....	205.0, Table 6-2
Continuous vent, definition .....	205.0
Continuous waste:	
Definition .....	205.0
Materials .....	405.0
Multiple fixtures .....	1001.0
Cooling units:	
Drains .....	801.0
Potable water waste pipes .....	808.0
Cooling water, connection permitted .....	808.0
Copper and lead pans .....	412.8
Copper pipe or tubing:	
Connection to screwed pipe .....	316.2.1
Fittings for .....	604.0, 701.0, 903.0, 1209.5.8.4
Forming .....	609.1
Joints and connections .....	606.2.1
Location and use of .....	604.0, 604.2, 701.1.4, 811.1, 903.0

## INDEX

Marking of ..... 604.3  
 Quality and weight of material ..... 604.2, 604.2, 701.1.4  
 Support of ..... 314.0  
 Corrections, inspection ..... 103.5.6.1-2  
 Corrosion, protection from ..... 313.5, 609.3.1, 1211.1.3  
 Cover plate ..... 707.9, 710.10  
 CPVC—Chlorinated poly (vinyl chloride) ..... 205.0, 604.1,  
 Critical level ..... 205.0, 603.4.5  
 Cross-connections ..... see Backflow, Back-Siphonage  
   Approval of preventive devices ..... 601.0-603.0  
   Backflow preventers ..... 602.0-603.0  
   Control ..... 601.0-603.0  
   Critical level ..... 603.4.5  
   Definition ..... 205.0  
   Prohibited ..... 407.1, 408.5, 601.0-603.0  
   Vacuum breakers ..... 603.2.2, 603.2.5, 603.2.6  
 Cross-linked polyethylene (PEX), definition ..... 218.0  
 Cutting of structural members ..... 313.2

### - D -

Damage to drainage and sewer systems ..... 306.0, 714.0  
 Dangerous or insanitary plumbing ..... 101.5.2  
 Defective material, gas ..... 1214.0  
 Defective systems, testing of ..... 103.5.5.1  
 Definition of terms ..... Chapter 2, 502.0, 1203.0  
 Demand, gas appliance ..... 1209.4.2  
 Department Having Jurisdiction, definition ..... 206.0  
 Detrimental wastes ..... 307.0, 1009.0  
 Developed length:  
   Definition ..... 206.0  
   Trap arm ..... 1002.0, Table 10-1  
 Diameter, definition ..... 206.0  
 Dielectric insulator ..... 508.1  
 Direct connection of water piping to sewer ..... 602.0-602.2,  
   805.0, 807.1, 808.0  
 Direct vent water heater ..... 502.7, 505.1  
 Direction, change of ..... 706.0-707.0, 719.0  
 Discharge capacity, fixture ..... 702.0  
 Dishwasher connection, domestic ..... 807.4  
 Disposal fields for septic tanks ..... Table 7-1, Appendix K,  
   Table K-1  
 Disposal of:  
   Food waste ..... 405.4, 714.4, 1001.3, 1015.0  
   Liquid waste ..... 303.0  
 Distance of trap from vent ..... 1002.2, Table 10-1  
 Distribution boxes, disposal fields ..... Appendix K  
 Domestic sewage, definition ..... 206.0  
 Doors, shower stalls ..... 412.6  
 Double traps, prohibited ..... 1004.0  
 Dosing tanks ..... Appendix K  
 Downspout, definition ..... 206.0  
 Drain:  
   Building, definition ..... 204.0  
   Fixture, definition ..... 208.0  
   Floor ..... 412.0, 1006.0  
   House, definition ..... 208.0  
   Sub-drains (showers) ..... 412.8  
 Drainage:  
   Below curb and main sewer level ..... 710.0  
   By gravity required ..... 709.0  
   Change in direction . see Change in direction, drainage  
   Connection to sump ..... 710.0  
   Connection to sewer or private  
   disposal system ..... 305.0, 713.0  
   Damage to ..... 306.0, 701.0, 714.0  
   Defective ..... 103.5.5.1, 306.0, 714.0

Durham or recessed screwed fittings 311.8, 701.0, 701.2  
 Fittings, material ..... 311.8, 701.2, 707.0  
 Grade or fall ..... 708.0, 718.0  
 Indirect wastes ..... 801.0-808.0  
 Length between trap and vent ..... 1002.2, Table 10-1  
 Material of ..... 301.0, 701.0, 811.0  
 Protection of ..... 313.0  
 Sizes of, minimum ..... 703.0  
 Steam and hot water ..... 810.0  
 Support ..... 314.0-315.0, 718.0  
 Waste and vent ..... Table 7-5  
 Drilling, improper notching ..... 313.11  
 Drinking fountains ..... 406.1, 809.0  
 Drum traps, vented ..... 1004.0  
 Durham system, definition ..... 206.0

### - E -

Easements for sewers ..... 308.1, 721.2  
 Effective opening, definition ..... 207.0  
 Ejectors ..... 710.0  
 Example, illustrating use of gas tables ..... 1217.0  
 Excavations ..... 315.0, 1204.0  
 Exceptions:  
   Cesspools ..... Appendix K  
   Connection to sewer ..... 713.6  
   Drainage piping, size ..... 703.0  
   Gas test ..... 1204.2  
   Gas water heater vents ..... 510.1  
   Independent systems ..... 312.0  
   Tests ..... 103.3.5  
   Vent size ..... Table 7-5, 904.0  
   Water piping ..... 610.13, 720.0  
 Excessive water pressure ..... 608.2  
 Existing work ..... 101.4.1.3, 207.0, 301.0  
 Expansion joints ..... 705.3.2  
 Expansion of pipe, provision for ..... 313.2

### - F -

Fall of sewers ..... 718.0  
 Faucets ..... 601.0, Table 14-1  
 Fees ..... 103.3-5, Table 1-1  
 Ferrules, caulking ..... 701.4, 705.3.3, Table 7-1  
 Fill, for building sewers ..... 718.0  
 Final inspection, certificate ..... 103.5.6.3, 1205.0  
 Fittings:  
   Cleanout ..... 707.0, Table 7-6  
   Drainage ..... 701.2  
   Gas piping ..... 1209.5.4, 1209.5.8, 1209.5.9  
   Inlet, for fixture connections ..... 704.1  
   Material of ..... 604.0, 710.4, 1209.5  
   Prohibited ..... 311.0, 604.10, 903.3, 1209.5  
   Screwed ..... 311.8  
   Threaded ..... 311.8  
   Water piping ..... 604.0  
 Fixture:  
   Branch, definition ..... 208.0  
   Connections ..... 704.0  
   Drain, definition ..... 208.0  
   Flanged connection ..... 316.3  
   Supply ..... 208.0, 601.0, 610.0  
   Unit ..... 208.0, 702.0  
   Unit flow rate ..... 610.0, 702.0  
 Fixtures ..... see Plumbing Fixtures  
 Flagpoling of vents ..... 906.3  
 Flammable Vapor or Fumes ..... 208.0  
 Flanges ..... 316.1-3, 704.4

## UNIFORM PLUMBING CODE

Flared joints	.606.1.1, 705.3.3
Flashing	.313.8, 510.6.1.3, 906.5
Flood level	.208.0, 807.4-1
Flood-level rim	.208.0, 603.3.5
Flooded, definition	.208.0
Floor drains	.412.0
Backwater valve required	.1006.0
Trap location and type	.412.0, 1006.0
Water supply	.601.0
Water trap supplies (primers)	.1007.0
Floor flanges	see Flanges
Floors, under shower compartments	.412.0
Flow rates, in fixture units	.610.0, 702.0
Flue Collar	.502.8
Flush tanks	.208.0, 601.0
Flush valves, definition	.208.0
Flushometer tank	.208.0, 603.4.3
Flushometer valve	.208.0, 411.3, 603.4.1, 610.10, Tables 6-4 & 6-7
Flux, solder	.316.1.3
Food-handling equipment	.801.2
Food waste disposal unit	.405.4, 714.4, 1015.0
Freezing, protection of pipes	.313.6, 609.1

- G -

Gang or group showers, definition	.209.0
Garbage grinder	see Food Waste Disposal Unit
Food waste disposer	.1015.0, 405.0, 407.0
Gas	Chapter 12
Appliance connectors	.1203.1, 1212.1
Appliance demand	.1209.4.2, Table 12-1
Authority to disconnect	.1207.0
Authority to render service	.1206.0
Capping or plugging outlets required	.1207.3
Connectors	Table 12-13, Table 12-14, 1212.0
Definition	.1203.0
Demand, appliance	Table 12-1, 1209.4.2
Disconnecting appliances	.1207.0
General	.1202.0
Hourly volume, rating	.1216.0
Inspection	.103.5, 1204.0
Installation of	.1202.0, 1211.0
Leaks	.1214.1
Liquefied Petroleum	.1213.0
Location of meters and access thereto	.1209.6
Material of	.1209.0
Meters	.1209.6
Meters, location	.1209.6
Piping, definition	.1203.3
Piping size	.1216.0, 1217.0, Table 12-7 to Table 12-23
Piping system, definition	.1203.4
Plans required	.101.3
Service piping, definition	.1203.8
Test	.103.5.3.2, 1208.0
Temporary use of	.1208.0
Underground piping	.1211.1
Utility supplying	.1205.0
Gas piping:	
Access to meter	.1209.6
Defects, cracks, splits, prohibited	.310.0, 1214.1.5
Definition	.1203.0
Inspection and testing	.1204.0
Installation	.1202.0
Material	.1209.5
Required gas supply	.1216.0
Size	.1216.0, 1217.0
Supporting fixtures	.1211.2.6, Table 12-3
Unions	.1211.3.2(4)
Gas water heater; see definition	.502.14

Approval requirements	.501.0
Clearances	.505.3
Combustion air required	.507.0
Draft hoods	.510.12
Inspections	.504.0
Oil burning or other	.506.0
Permits required	.503.0
Pressure relief valves	.608.0
Prohibited locations	.1213.0
Protection	.505.0, 506.0, 510.0
Sealed combustion	.502.0, 509.0, 510.0
Vent required	.510.2.1
Gas water heater vent:	
Approved type required	.510.6
Area of	.510.6.3
Common vent	.510.10.4
Connector	.510.10
Damper prohibited	.510.15
Definitions	.502.0
Draft hoods	.510.12
Engineered system	.510.7.5.1
Existing masonry chimneys	.510.5.4
Hood, cap or cowl	.510.6.1.3
Inspections	.504.0
Location and support	.510.6.5, 510.7.6
Location of draft hood and connectors	.510.12.5
Material	.510.10.2
Mechanical draft systems	.510.3.4
Protection and support	.510.6.5
Required	.510.2.1
Size of	.511.0
Termination	.510.6.2
Grade:	
Building sewer	.718.0
Definition	.209.0
Horizontal drainage	.708.0
Gravity drainage required	.709.0
Gravity supply tanks	.607.0
Graywater systems	Appendix G
Grease interceptors	Chapter 10, Appendix H
Definition	.209.0
Design and construction	Appendix H
Where required	.1009.0-1014.0
Grease traps:	
Construction and design	.1014.0
Definition	.209.0
Sizes	Table 10-2
Ground joint connections	.705.3.3
Grounding	.604.8

- H -

Hangers	see Supports
Harmful waste	see Waste, detrimental and harmful
Health and safety	.101.2, 101.5.2, 301.0
High hazard	.210.0, Table 6-1
Horizontal branch	.210.0, 703.0
Horizontal pipe, definition	.210.0
Horizontal-to-horizontal drainage fittings	.706.0
Horizontal-to-vertical drainage fittings	.706.0
Horizontal vent pipes	Table 7-5, 904.0
Hose connections	.603.2.3, 1212.0
Hot-mopped shower pans;	see Shower pans
Hot water boiler	.603.3.10, Table 14-1
Hot water pipe sizing	.610.0
House drain	see Building sewer

## INDEX

House sewer .....see Building sewer  
 - I -

### Identification:

Copper tubing .....604.3  
 Gas piping .....1209.6.5, 1209.7.7  
 Piping, fittings, traps, and fixtures .....301.0, 1003.1  
 Required .....301.0  
 Water lines, non-potable .....601.2

Increases .....311.0, 316.4, 317.0

Independent system of sewers .....312.0

### Indirect waste:

Appliances .....807.0  
 Condensers and sumps .....810.1  
 Cooling water .....808.0  
 Drinking fountains .....809.0  
 Food-handling equipment .....801.2  
 Sterilizing equipment .....806.0

### Indirect waste piping:

Approval required .....802.0  
 Cleanouts .....803.0  
 Connections .....801.0, 805.0  
 Definition .....211.0  
 Hot water .....810.0  
 Maximum length .....803.0  
 Required .....801.0  
 Size of .....803.0  
 Steam and hot water .....811.1  
 Vents .....803.0

### Indirect waste receptors:

Approval required .....802.0  
 For clothes washers .....804.0  
 Materials .....803.0  
 Prohibited location .....804.1  
 Required water supply .....601.0, 1007.0  
 Size of .....804.1

Individual vent .....211.0, Table 7-5, 1014.0

Industrial interceptors and separators .....1008.0-1012.0, 1009.0

Industrial wastes .....211.0, 307.0

Approval required .....811.1, 1009.2  
 Disposal .....811.0  
 Materials .....811.2, 1009.2  
 Pretreatment .....811.1

Inlet fittings for fixture connections .....704.2

### Insanitary:

Construction .....101.4.1.3  
 Definition .....211.0

### Inspection and testing:

Abandoned sewers, cesspools .....721.0, K 1-K 11  
 Advance notice for .....103.5.4.1, 1204.0  
 Building sewer .....723.0  
 Certificate .....103.5.6.3, 1205.0  
 Concealment of work, prohibited  
 before inspection .....103.5.1.3, 1204.0  
 Disposal fields .....Appendix K  
 Final .....103.5.6.3, 504.0, 1204.0  
 Flues and vents .....504.0  
 Gas piping, rough and final .....1204.0  
 Labor and material for .....103.5.4.2  
 Water heaters .....505.0  
 Water piping .....103.5.1.1, 103.5.3.1

Inspector .....see Authority Having Jurisdiction

### Installation of:

Building sewer: .....715.0, 717.0, 718.0  
 Cleanouts .....707.0, 719.0, 803.0, Table 7-6  
 Devices to prevent cross-connections .....602.0, 603.0  
 Drainage piping system .....Chapter 7

Fixtures .....408.0  
 Floor drains and shower stalls .....412.0  
 Gas piping systems .....1211.0  
 Overflows .....404.0  
 Urinals .....406.0, 409.0  
 Vents .....Chapter 9  
 Water piping system .....609.0  
 Insulator, dielectric .....508.1  
 Intake, air, vent termination near .....906.2  
 Integral traps .....1001.1, Table 7-3  
 Intercepting hoppers or sink .....see Receptors  
 Interceptors:  
 Abandoned .....Appendix H 108.0  
 Auto wash rack .....1011.0  
 Cleaning required .....Appendix H 104.1  
 Cleanouts, location .....707.8, Appendix H 103.2  
 Commercial .....1014.10, Appendix H 101.0  
 Definition .....209.0  
 Design .....Appendix H 103.0  
 Effluent sampling .....Appendix H 107.0  
 Grease .....1009.0-1015.0, Appendix H 101.0  
 Industrial .....1009.0  
 Location .....1009.5, Appendix H 104.0  
 Maintenance .....101.4.1.2, 1009.5, Appendix H 104.0  
 Packing establishments .....1010.0  
 Required .....1009.0  
 Sizing .....Appendix H 106.0  
 Slaughterhouse .....1010.0  
 Vent .....902.0  
 Waste discharge requirements .....Appendix H 102.0  
 Intermixing of metals prohibited .....311.6, 508.1, 604.1  
 Invert, definition .....211.0  
 Iron pipe size (IPS) pipe .....302.0  
 Island fixture, venting .....909.0

## - J -

### Joints and connections:

Additives prohibited .....705.1.5  
 Brazed .....212.0, 316.1.7, 609.3.2  
 Cast iron .....705.1, 705.2  
 Cement mortar, prohibited .....705.1.2  
 Compounds, thread lubricants .....316.1.1, 1211.1  
 Compression .....316.1.5, 606.2.1  
 Copper to iron .....311.6, 316.2.1  
 Copper tube .....316.2.1, 606.2.1  
 Earthenware to metal .....316.3.1  
 Elastomeric gasketed .....705.1.7  
 Expansion .....705.3.2  
 Fixture .....316.3, 408.0  
 Flexible .....316.1.5  
 Floor-mounted .....316.3, 704.0  
 Gas and watertight .....103.5.3.5  
 Gas piping .....1211.1  
 Ground joint unions .....705.3.3  
 Hubless cast iron .....705.1.9  
 Increases and reducers .....317.0  
 Lead .....316.1.2, 705.1, 705.2.4  
 Mechanical .....606.1.2  
 Molded rubber .....705.1.6  
 Prohibited fittings and practices .....311.0, 316.4, 317.0  
 Rubber ring .....705.1.7  
 Screwed .....316.1.1  
 Shield coupling .....705.1.8

## UNIFORM PLUMBING CODE

Slip .....405.2, 705.3.1, 1003.2  
 Soldered or sweat ..... 212.0, 316.1.3  
 Solvent cement ..... 316.1.6  
 Special ..... 316.2  
 Threaded ..... 316.1.1, 316.2.3  
 Tightness ..... 103.5.3.5  
 Tubing ..... 316.1.3, 316.2.1, 606.2.1, 1209.5  
 Union ..... 316.2.2, 609.5, 1211.3.2  
 Vitrified clay ..... 705.2.1, 705.3  
 Welded ..... 225.0, 705.1.3, 1211.3.2  
 Wiped ..... 316.1.2  
 Jurisdiction, Department Having, definition ..... 206.0

- K -

Kitchen sinks, prohibited types ..... 406.3

- L -

Labeled, definition ..... 214.0  
 Labor for tests ..... 103.5.4.2  
 Laboratories, chemical ..... 811.0  
 Latrines or range toilets prohibited ..... 905.0  
 Laundry tubs ..... 1003.1  
 Lavatories ..... 414.1  
 Lavatories in sets, definition ..... 214.0  
 Lawn sprinklers ..... 603.4.6  
 Lead joints ..... see Joints, Lead and Connections  
 Lead:  
     Sheet ..... 401.2, 701.3  
     Shower receptor ..... 412.8  
 Lead pipe:  
     Support of ..... 314.0  
     Traps and bends ..... 701.3  
 Leader, definition ..... 214.0  
 Leaks, gas piping ..... 1214.0  
 Length:  
     Developed, definition ..... 206.0  
     Drainage piping ..... 703.0, Table 7-5  
     Vent piping ..... Table 7-5, 904.0  
 Length and size of gas pipes ..... 1217.0  
 Length and size of water pipes ..... 301.0  
 Liquefied petroleum gas (LPG) ..... 1201.0, 1203.5, 1213.0  
 Liquid waste:  
     Definition ..... 214.0  
     Disposal of ..... 303.0  
 Listed ..... 214.0  
 Listing Agency, definition ..... 202.0  
 Loading, fixture unit ..... Tables 6-4, 7-3 & 7-4  
 Location of:  
     Backwater valve ..... 710.1, 710.4, 710.6, 1006.0  
     Fixtures ..... 309.0, 408.5  
     Gas meters and risers ..... 1209.1  
     Gas valves ..... 1209.1  
     Industrial interceptors and separators ..... 1009.0  
     Plumbing or sewer on lot ..... 308.0, 721.0, Table 7-7  
     Pressure-relief, regulator, or check valves ..... 608.0, 1209.7  
     Private sewage disposal system ..... Appendix K  
     Secondary protection, water heaters ..... 506.2  
     Shutoff valves ..... 605.0, 1209.10, 1211.9.2  
     Temperature relief valves ..... 608.3  
     Vent terminals ..... 510.6.2, 906.0  
     Water heaters ..... 502.14, 505.0, 508.0  
 Lot, definition ..... 214.0  
 Lot line, termination of vents from ..... 906.0  
 Low hazard ..... 214.0, Table 6-2

Lubricants, thread ..... 316.1.1, 705.1.5, 1209.5.7(d)

- M -

Macerating Toilet System, definition ..... 215.0, 710.14  
 Main, definition ..... 215.0  
     Sewer ..... see Public Sewer  
     Vent, definition ..... 215.0  
     Water main ..... 225.0  
 Maintenance ..... 101.4.1.2, 1007.0, 1009.6, 1014.6  
 Material:  
     Alternate ..... 301.0, 403.0  
     Approval required ..... 301.0  
     Backwater and gate valves ..... 605.4, 710.4, 710.6, 1210.5  
     Building drain ..... 701.0  
     Building sewer ..... 715.0  
     Cesspool ..... Appendix K  
     Cleanouts ..... 707.2  
     Combustible, definition ..... 502.6  
     Condensers ..... 810.2  
     Drainage systems ..... 701.0  
     Fittings ..... 301.0, 311.8, 605.1, 707.2, 710.4, 710.6, 1209.5  
     Gas piping ..... 1209.5  
     Marking of ..... 301.0, 604.3, 710.6, 716.0, 1003.1  
     Plumbing fixtures ..... 306.0, 313.0  
     Protection of ..... 304.0, 315.0, 1213.0  
     Septic tank ..... Appendix K  
     Showers ..... 412.0  
     Shower control valves ..... 420.0  
     Soil and waste pipes ..... 701.0  
     Special ..... 301.0  
     Specifications, standards ..... 301.0, Table 14-1  
     Sumps ..... 710.8  
     Thread lubricants ..... 316.1.1, 1209.5.7(d)  
     Traps ..... 316.1.1, 1212.7  
     Valves and fittings ..... 311.0  
     Vents ..... 903.0  
 May, definition ..... 215.0  
 Meat packing and slaughterhouses ..... 1010.0  
 Medical gas systems ..... Chapter 13  
 Metals, intermixing prohibited ..... 311.6  
 Meters, gas:  
     Location of ..... 1209.6.2  
 Meters, water ..... 610.1, 610.8, Appendix A  
 Minimum standards ..... 301.0  
 Mobile homes ..... Table 7-3, Table 6-4  
 Mobile home park sewer ..... Appendix E  
 Mortar, cement joints prohibited ..... 705.1.2

- N -

Natural gas, specific gravity ..... 1216.0  
 Nipples, soldering ..... 316.1.2  
 Non-corrosive bolts ..... 408.3, 408.4  
 Notching ..... 313.2  
 Non-potable water piping ..... 603.4.12, 610.13(6)  
 Notice of inspection ..... 103.5.4.1  
 Nuisance ..... 101.4.1.3, 216.0, 713.6, 714.6

- O -

Obstructions to flow ..... 311.5, 316.4.1-2  
 Offset ..... 217.0, 510.6.1.4, 706.4, 905.3  
 Oil interceptors ..... 1009.0  
 Opening, effective, definition ..... 207.0  
 Open trench work ..... 315.3  
 Overflow:  
     For gravity supply tank ..... 607.0  
     Plumbing fixture ..... 404.0  
     Rim, flood-level rim ..... 208.0, 404.0





## UNIFORM PLUMBING CODE

Cement mortar joints	.705.1.2
Concealment of defects	310.2, 1214.3
Concealment of work before inspection	.103.5.1, 705.1.1
Connections, rainwater	.306.2
Connections, waste	.404.0, 801.1, 801.2, 805.0, 806.0
Connections, water	.602.0
Copper tubing, use of	.903.2.3, 1209.5.2.3, Table 14-1
Damage to drainage system	.306.1, 313.0
Defective material	.103.1.2.1, 301.1.1, 1214.3
Direct drainage	.603.3.5, 801.1, 810.1
Double trap fixture	.1004.0
Drinking fountain location	.406.1
Fittings	.311.0, 316.4
Fixtures	.311.5, 406.0, 409.2
Food waste disposal, connection to	.1001.3, 1013.0
Gas water heaters in bathroom, bedroom	.505.1
Industrial waste disposal	.307.0
Joints and connections	.316.4, 606.2.2, 705.1.2, 705.1.5
Liquefied petroleum gas, location of	.1213.0
Pipes in masonry	.313.2
Practices	.101.4.1.1.2, 310.2, 311.0, 313.2, 313.4, 313.6, 316.4, 602.0, 714.0
Receptors, location of	.804.1
Trap joints	.1003.0
Traps	.1004.0
Trough type urinals	.406.2
Union couplings in gas piping	.1211.3.2(4)
Urinals and water closets on combination waste and vent	.910.7
Water jacketed grease interceptor	.1011.7
Water piping in drainage or sewer trench	.720.0
Zinc alloy die cast components	.403.1
Property line, termination of vent	.906.2
Protection from:	
Corrosion	.313.1, 313.5, 609.3.1, 1209.5.6
Freezing	.313.6
Protection of:	
Piping materials and structures	.313.0, 1209.5
Potable water supply	.603.0
Trap seal	.1002.1, 1005.0, 1007.0
Water heaters	.505.3, 506.2, 510.0
Public, or public use, definition	.218.0
Public sewer, definition	.218.0
Public shower floors	.412.1

- Q -

Quality and weight of materials, general regulations	Chapter 3
Quality of fixtures	.401.0
Quick-disconnect device	.1212.1, 1212.5, Table 14-1

- R -

Rain and surface water drains	.306.2, 714.2
Rainwater systems	Chapter 11, Appendix D
Rate of flow, fixture unit	.610.0, Table 6-3, 702.0, Table 7-3
Reaming pipes	.310.3, 606.1.1, 701.2.1, 903.4, 1210.2
Receiving tank or sump	.710.2-3, 710.7-10, 710.12
Receptors:	
Accessible	.804.1, 811.4
Approval required	.802.0, 804.1
Connected indirectly to sewer	.801.1-2
Definition	.220.0
Indirect waste	.804.0
Maximum distance from fixture	.804.1
Required	.801.1-2, 811.1
Shower, shower stalls	.412.0
Size of trap, vent, waste	.803.0

Type and size	.804.1
Recessed or Durham fittings	.206.0, 701.2.1
Reclaimed water	Appendix J
Recommended loadings, sewage disposal	Table 7-5, Appendix K
Reducer, where required	.317.0
Refrigerators	Table 7-3, 801.2
Regulators, gas supply	.1218.4-7
Regulators, relief valves on water supply	.608.2-6
Relief vent	.220.0, 907.0
Connections	.805.0
For closed condensers, sumps, interceptors	.810.1-2, 1009.0
Remote outlet, definition	.220.0
Repairing:	
Defective gas pipe, prohibited	.1204.3, 1207.0
Defective pipe and fittings	.101.5.2
Repairs and alterations to plumbing and drainage system	.101.4.1.1
Required:	
Plans	.101.3
Plumbing fixtures	.412.1
Sewer connections	.304.0, 305.0
Vents	.901.0
Responsible for testing	.103.5.4.2
Restaurant, grease trap	.1014.1
Retesting	.103.5.6.2
Rim:	
Definition	.220.0
Flood level	.208.0, 603.3.5, 603.4.6, 603.4.9, 905.3, 909.0
Rise:	
Horizontal vent	.905.3
Vents above fixture	.905.3
Riser	.220.0, 610.1
Roof drains	.220.0, 306.2, Table 14-1
Roof supply tanks	.607.0, Table 14-1
Roof, termination of vents above	.510.6.2, 906.1, 906.3, 906.7
Roughing-in, definition	.220.0
Running water, required	.601.1

- S -

Saddle, sleeve, band outlets, prohibited	.311.1
Safety and health	.101.5.2
Safety devices	.505.0, 603.3-15, 608.0, 1007.0, Table 14-1
Sand interceptor:	
Cleanout for	.707.8, Table 14-1
Definition	see Interceptor
Design	.1009.1, 1009.3
Required	.1016.1
Required for steam exhaust or blow off	.810.0, Table 8-1
Secondary	.902.1
Type of trap	.1009.2
Vent, required and not required	.901.0, 902.0, 1002.1-2, 1002.4
Water seals	.1007.0
Sanitary plumbing test	.103.5.5.1, Table 14-1
Sanitary tees, permissible use	.706.2
Screw pipe, supporting of	.314.0
Screw pipe to cast iron	.705.2.3
Screw pipe to copper tubing	.316.2.1
SDR, definition	.220.0
Seal, trap; see Trap, seal	.1005.0, 1007.0
Screw joints	.316.2.1, 705.2.3, Table 14-1

## INDEX

- Secondary energy protection .....505.3, 506.2  
 Secondary sand interceptors ..... 902.0  
 Secondary temperature limiting device ..... 506.2  
 Seepage lines ..... Appendix K  
 Seepage pit ..... Appendix K  
     Abandoned ..... Appendix K  
     Construction ..... Appendix K  
     Location ..... 721.0, Table 7-7  
     Size ..... Appendix K  
     Soil absorption ..... Appendix K  
 Self-cleaning traps ..... Table 7-3, 1003.1  
 Separate plumbing and drainage systems ..... 312.0  
 Separate venting ..... 811.6, 906.3  
 Separator ..... 1009.0  
 Septic tanks ..... 221.0, 301.1.1, Appendix K  
     Abandoned ..... 722.2–5, Appendix K  
     Connections to sewer prohibited ..... 714.3  
     Location of ..... 721.0, Table 7-7  
     Wastes, connection to ..... 714.3  
 Service, authority to render gas ..... 1206.0  
 Service piping, gas, definition ..... 1203.8  
 Setting fixtures ..... 316.3.1, 408.6  
 Settling tank ..... 902.1  
 Sewage:  
     Definition ..... 221.0  
     Disposal of ..... 303.0, 305.0, 709.0, 713.0, 714.0,  
         1010.0, 1014.0  
 Sewage disposal system, private ..... Appendix K  
     Construction ..... 713.3  
     Holding tank ..... 714.5  
     Location ..... 721.0, Table 7-7  
 Sewage ejector, definition ..... 221.0  
 Sewage pump, definition ..... 221.0  
 Sewers ..... Chapter 7  
     Abandoned ..... 722.0  
     Adjacent to walls ..... 715.1, 718.3, Table 7-7  
     Available ..... 305.2, 713.2, 713.4  
     Building, material of ..... 701.0, 715.1  
     Building sewer ..... 204.0, Chapter 7  
     Cleanouts ..... 719.0  
     Connection to, required ..... 304.0, 305.0, 713.0  
     Construction of ..... 715.0–719.0, Table 7-7  
     Damage to ..... 306.1, 714.1, 811.1  
     Depth of ..... 708.0, 718.3  
     Easements for ..... 721.2  
     Ejectors ..... 710.2  
     Existing ..... 101.4.1.1.1–2, 312.0, 705.1.2, 713.6  
     Grade and support of ..... 708.0, 713.6, 718.0  
     Independent system required ..... 312.0  
     Inspection, order of ..... 103.5.1  
     Installed on made or filled-in ground ..... 103.5.1.4, 718.2  
     Location ..... 308.0, 313.0, 718.0, 720.0, 721.0, Table 7-7  
     Materials ..... 101.4.1.1.2, 715.1, 718.3, 720.0  
     Mobile home ..... 215.0, Appendix E  
     Must be on same lot as building ..... 308.1, 312.0, 721.1  
     Pipe joints ..... 705.1, 705.3.1, Table 14-1  
     Private sewage disposal system ..... 218.0, 305.1–2,  
         713.1–2, 713.6  
     Public, definition ..... 218.0  
     Public, damage to ..... 306.1, 714.1  
     Required ..... 305.1–2, 713.1–2, 713.6  
     Size of building ..... 710.5, 717.0, Table 7-8  
     Testing of ..... 101.4.1.1.2  
     Water pipe in trench ..... 1108  
 Shall, definition ..... 221.0  
 Sheet lead ..... 412.8, 701.3, Table 14-1  
 Shielded couplings ..... 221.0, 705.1.8  
 Shock arrester, definition ..... 221.0  
 Short turn 1/4 bend, prohibited ..... 311.5, 706.1  
 Should, definition ..... 221.0  
 Shower stall or compartment ..... 412.7  
 Showers, gang, drainage ..... 209.0, 412.10, Table 7-3  
 Shower pans ..... 412.8  
 Shower receptors ..... 412.8  
 Shutoff valves ..... 605.3, 710.4, 1211.9.3  
 Single-family dwelling, definition ..... 221.0  
 Sinks:  
     Chemical, special use ..... 403.0  
     Island ..... 909.0  
     Prohibited ..... 406.3  
 Sinks and laundry tubs ..... 1001.2–3  
     Types prohibited ..... 406.3  
 Size of:  
     Building sewer ..... 703.0, 705.0, 717.0, Tables 7-3,  
         7-8 & 14-1  
     Cesspool ..... Appendix K  
     Combination waste and vent piping ..... 805.0, 910.0,  
         Appendix B  
     Combustion air vents ..... 506.1, 507.1  
     Disposal field ..... Appendix K  
     Drainage piping, minimum ..... 703.0, 707.3, 707.10,  
         Table 7-3  
     Gas piping system ..... 1216.1, 1217.0, 1218.6–7,  
         Tables 12-5 to 12-8  
     Indirect waste pipes ..... 803.0  
     Pipe cleanout ..... 707.11, Table 7-6  
     Seepage pit ..... Appendix K  
     Septic tank ..... Table 7-3, Appendix K  
     Trap ..... 702.0, Table 7-3, 910.4, 910.6, 1003.3, 1006.0  
     Vent pipes ..... 710.10, Table 7-5, 810.1, 904.0, 905.4,  
         906.3, 908.2, 908.3, 910.3,  
         Table 7-5, 904.0, 907.1  
     Water piping ..... 610.0  
 Slaughterhouses ..... 1010.0  
 Slip joints ..... 316.1.5, 705.1.6, 705.1.8–9, 705.3.1, 705.3.3  
 Slip joints, traps ..... 705.3.1, 1003.2  
 Slope ..... see Grade  
 Softener ..... 610.2, Table 14-1  
 Soil pipe ..... 221.0, 311.2, 311.4, 311.6, 704.4.1,  
     704.3.3, 705.1.9, 722.2, 801.1–2, 1002.4  
 Soil porosity ..... Appendix K  
 Soil stack, minimum size ..... 703.0  
 Solder, bushings and ferrules ..... 316.1.2, 701.4.2,  
     Tables 7-1 & 7-2  
 Solder fluxes ..... 316.1.3  
 Solder joints ..... 212.0, 316.1.2–3, 316.2.1, 316.3.1,  
     606.2.1, 705.3.4  
 Spacing:  
     Gas risers or meters ..... 1209.2, 1211.5  
     Pipe supports ..... 314.1, 314.7, Table 3-1  
 Special fixtures ..... 403.0, 407.0, Table 14-1  
 Special joints ..... 316.2.1, Table 14-1  
 Special waste pipe ..... see Industrial Waste  
 Special wastes:  
     Acid and chemical ..... 811.0, 1008.1  
     Definition ..... 202.0  
     High temperatures ..... 810.1, Table 8-1  
     Laundries, bottling works, wash racks ..... 702.0, 711.0,  
         1008.1, 1010.0  
 Specific gravity, natural gas ..... 1216.1, Tables 12-4 & 12-6  
 Specifications for materials ..... Chapter 3, Table 14-1  
 Stack ..... 221.0, 311.4, 705.3.2, 711.0, 904.0, 906.1, 907.0  
 Standards for materials ..... Chapter 3, Table 14-1  
 Standpipe, clothes washer ..... 804.1

# UNIFORM PLUMBING CODE

Steam boiler, water connection to ..... 603.3.11  
 Steam exhaust condenser or blow off ..... 810.0, Table 8-1  
 Sterile equipment ..... 806.0  
 Storage tanks:  
   Gravity ..... 607.0, Table 14-1  
   Hot water ..... 505.3, 506.2, Table 14-1  
 Storm drain, definition ..... 221.0  
 Storm sewer, definition ..... 221.0  
 Strainers ..... 405.1, 410.1  
 S-trap prohibited ..... 1004.0  
 Street main; see Water main ..... 225.0, 610.7, Table 6-5  
 Structural condition safety ..... 313.0  
 Studding and joists, cutting of ..... 313.2  
 Sub-drain, shower stalls ..... 412.8  
 Submittal of plans ..... 101.3, 103.2.1.4, 103.3.1, 103.4.2-3  
 Subsoil drain, definition ..... 221.0  
 Subsoil drainage ..... 710.12  
 Substitute materials ..... 301.0  
 Subsurface disposal field ..... Appendix K  
 Suds relief ..... 711.0  
 Sump:  
   Boiler room, installation ..... 810.1, 810.3  
   Building, backwater devices ..... 710.2  
   Building drainage systems below sewer level ..... 710.2  
   Condensers ..... 810.0, Table 8-1  
   Construction ..... 810.2  
   Definition ..... 221.0  
   Pump connection permitted ..... 710.2-3, 710.9, 805.0,  
     Table 7-4  
   Pump discharges, conversion to fixture units ..... 710.4,  
     Table 7-4  
   Sewage ..... 710.0  
   Vent ..... 710.7, 710.10, 810.1, Table 8-1  
 Supply:  
   Control valves, water ..... 605.5, 605.7  
   Fittings, fixtures ..... 408.6  
   Fixture, definition ..... 208.0  
   Hot water ..... 103.5.3.3, 601.3, 602.1, 604.1  
   Non-potable water ..... 603.4.12  
   Pipe, size of ..... 608.2, 610.0, Table 6-5  
   Potable water, protection ..... 603.0, 603.2.5  
   Tank, water ..... 605.3, 607.0, 608.1, 608.3  
   Trap, seal ..... 1004.0, 1005.0, 1007.0  
   Water, quality of, source of ..... 601.1  
 Supports and hangers ..... 221.0, 314.0, Table 3-2, 515.0, 609.1  
   906.4, 1211.2.6, Table 12-3  
 Surface water, discharge ..... 307.2, 714.2, 811.1, 1010.0  
 Surrounding material, urinals ..... 408.4-5  
 Sweat joints ..... 316.1.3, 316.2.1  
 System:  
   Combination waste and vent ..... 205.0, 910.0  
   Defective, testing of ..... 103.5.5.1  
   Drainage ..... 206.0, 712.0  
   Durham, definition ..... 206.0  
   Gas piping, size of ..... 1216.0  
   Independent ..... 312.0  
   Interconnection of gas piping ..... 1211.12  
   Plumbing, definition ..... 218.0  
   Vent ..... 224.0, 712.0  
   Water supply ..... 225.0, 609.0, 712.0

- T -

Tailpiece:  
   Connection ..... 807.2, 910.5-6  
   Maximum length of ..... 910.5  
 Tanks:  
   Automatic flushing, urinals ..... 411.2  
   Boiler blow off; see Condensers

and Sumps ..... 810.1, Table 8-1  
 Flush ..... 208.0, 404.0, 408.4, 411.2, 601.1, 603.3.8,  
   Table 7-3  
 Gravity supply ..... 607.0  
 Hot water storage ..... 608.3, 608.6  
 Inlet to ..... 603.4.2, 603.4.5, 710.9, 810.1  
 Liquefied petroleum ..... 1213.0, 1217.4  
 Material ..... 710.8, 810.2, Table 14-1  
 Primary settling ..... 902.1  
 Septic ..... see Septic Tank  
 Water closet ..... 404.0, 406.1, 601.1, 603.4.2-3  
 Water supply ..... 602.1, 607.0, 608.1, 608.3  
 Water supply, overflow ..... 603.4.2, 607.0, 805.0  
 Temperature limiting devices ..... 505.5  
 Temperature relief valves ..... 608.0, Table 14-1  
 Temporary use of gas ..... 1208.0  
 Termination of vents ..... 510.6.2, 906.1  
 Tests:  
   Advance notice for ..... 103.5.4.1  
   Air ..... 103.5.3.3, 103.5.3.5, 1214.1.7  
   Alternate materials, methods ..... 301.2.4-6  
   Building sewer ..... 101.4.1.1.2, 103.5.1.3-4, 723.0  
   Concealing of work prohibited  
     before inspection ..... 103.5.1.1, 103.5.1.3-4, 1204.0  
   Exceptions ..... 103.5.3.3, 1204.4  
   Final ..... 103.5.6.3, 712.1, 1204.3.2  
   Labor and material for ..... 103.5.4.2, 1204.2  
   Percolation ..... Appendix K  
   Required ..... 103.5.3, 603.3.8  
   Responsibility for ..... 103.5.4.2  
   Sanitary plumbing ..... 103.5.5.1  
   Testing agency ..... 301.2.4, 610.2, 1202.2  
   Waived ..... 103.5.3.2  
   Water supply system ..... 103.5.1.1, 103.5.3.3, 610.2  
 Threaded joints ..... 316.1.1, 316.2.1, 705.2.3  
 Threaded fittings ..... 311.2, 316.1.1, 316.2.1, 705.2.3  
 Thread lubricants ..... 316.1.1, 1209.5.7(d), 1213.7  
 Three-compartment sinks ..... 1001.2  
 Toilets:  
   Connections ..... 316.4  
   Prohibited type ..... 406.1  
 Trap ..... 222.0, 1003.0  
   Arm ..... 222.0, 1002.2-3, Tables 7-3, & 10-1  
   Drum ..... 1004.0  
   Exceptions for ..... 1001.2-3, 1002.3  
   Floor drain ..... 1003.1, 1006.0, 1007.0  
   For sumps, condensers ..... 810.1  
   For three-compartment sinks or three lavatories ..... 1001.2  
   From fixture, distance of ..... 1001.4  
   From vent, distance of ..... 704.2, 1002.2, Table 10-1  
   Grease ..... 209.0, 1014.0, Tables 1-1, 7-3, & 10-2  
   Ground metal joints ..... 705.3.4  
   Horizontal distance from vent ..... 704.2, 1002.2, Table 10-1  
   Indirect connection required ..... 801.0  
   Industrial interceptors and separators ..... 1009.0  
   Integral ..... 1001.0  
   Material of ..... 103.1.2, 301.1.1-2, 705.3.1, 807.3,  
     1003.1, Table 14-1  
   Minimum size ..... 702.0, 1003.3, Tables 7-3 & 7-5  
   Prohibited types ..... 1004.0  
   Protection ..... 603.3.8, 1002.1-2  
   Required ..... 1001.0  
   Seal ..... 222.0, 1005.0, 1007.0  
   Separate for each fixture ..... 1001.1  
   Size ..... 1003.3, Table 10-1  
   Slip joints in ..... 705.3.1, 1003.2

## INDEX

Supplies for ..... 1007.0  
 Union joint in water seal ..... 316.2.2, 1003.2  
 Unit loading ..... 702.0, Table 7-5  
 Vents for ..... 103.1.2, 810.1, 901.0, 905.2, 905.5,  
 908.1, 909.0, 910.6, 1002.0, 1001.5, Tables 7-5 & 10-1  
 Vent not required for ..... 902.0  
 Water seal ..... 1005.0  
 Weir ..... 905.5, 1001.4, 1002.2, 1002.4  
 Where required ..... 1001.0  
 Trenching, excavation, and backfilling ... 315.0, 718.0, 720.0  
 Trough urinals, prohibited ..... 406.1  
 Tubing, copper .... 316.1.3, 316.2.1, 604.1-2, 606.1.1, 606.2.1,  
 609.3.2, 701.1.4-5, 705.3.3, Table 14-1  
 Tubing, gas connectors ..... 1212.1, 1212.3  
 Tunneling ..... 315.2

### - U -

Unconfined space, definition ..... 223.0  
 Underground:  
   Copper tubing ..... 604.2, 701.1.4  
   Dosing tanks ..... Appendix K  
   Drainage material ..... 316.2.2, 701.0  
   Gas piping ..... 1211.1  
   Vent material ..... 316.2.2, 701.1.4, 903.1.1, 903  
   Water pipes ..... 609.0, 720.0  
 Unions:  
   Couplings, in gas piping ..... 1211.0  
   In vents ..... 316.2.2  
   Joint in seal of trap ..... 1003.2  
   Where allowed ..... 316.2.2, 1211.3.2(4)  
 Unit, fixture ..... 208.0, 610.0, 702.0, Tables 6-3 to 6-7 & 7-3  
 Unit loading of traps ..... 702.0  
 Unlawful connections ..... 602.0  
 Unsanitary, definition ..... 223.0  
 Urinals ..... 316.3.1, 402.2, 404.0, 406.1, 408.6, 410.0, 601.1,  
 707.4(1), 1003.1, Tables 7-3 & 7-5  
 Use of alternate material ..... 301.2  
 Use, private, definition ..... 218.0

### - V -

Vacuum breaker ..... 224.0, 409.0, 603.2  
   Tables 1-1, 6-2, 6-3, 14-1  
 Vacuum relief valve, definition ..... 224.0  
 Validity of code ..... 103.7.1, 103.8  
 Valves ..... 311.7, 605.0, Table 14-1  
   Backwater ..... 710.0  
   Check ..... 603.1.3-5, Table 6-2  
   Flush, definition ..... 208.0  
   Flushometer ..... 411.2-3, 610.10, Table 6-7  
   For drainage ..... 710.4, Table 14-1  
   For water ..... 605.0  
   Hose outlet protection ..... 603.3.8  
   Required ..... 605.0, 1211.19  
   Temperature and pressure relief ..... 608.2, Table 14-1  
 Vent or vent pipe:  
   Below trap weir ..... 905.5, 1002.4  
   Branch, definition ..... 204.0  
   Changes in direction of ..... 903.4  
   Chemical ..... 811.2, 811.5-6  
   Combination waste system design ..... 205.0, 910.0,  
   Appendix B  
   Common vent ..... 205.0, 908.3  
   Connections ..... 311.2, 805.0, 905.1, Table 8-1  
   Connectors ..... 510.10  
   Continuous, definition ..... 205.0  
   Distance of trap from ..... 1002.2, Table 10-1

Double fitting for ..... 704.2, 905.0  
 Drain and waste ..... Table 7-3, Chapter 7  
 Fittings ..... Table 7-5  
 Fixtures, back-to-back ..... 704.2, 905.6  
 Flagpoling, prohibited ..... 906.3  
 Flashing for ..... 313.8, 906.1, 906.5  
 Grade of ..... 905.1, 905.3  
 Height above fixture ..... 905.3, 909.0  
 Height above ground ..... 510.8.3  
 Horizontal ..... Table 7-5, 904.2, 905.3  
 Indirect waste ..... 801.1-2, 803.0, 805.0, 810.1, 902.0  
 Individual, definition ..... 211.0  
 Interceptors ..... 902.1, 1008.4  
 Island sinks and fixtures ..... 909.0  
 Length of ..... Table 7-5, 904.0  
 Material for ..... 811.2, 903.0  
 Method of installation ..... 311.5, 903.1.2, 906.4  
 Minimum size in each building ..... Table 7-5, 904.0  
 Not required ..... 803.0, 902.0  
 Not to be used as soil or waste pipe ..... 311.4, 801.1-2  
 Opening location ..... 905.5, 1002.4  
 Parallel, connection ..... 907.1  
 Pipe, grade and connection ..... 905.1, 905.3  
 Prohibited location of ..... 903.1.1-2, 903.3  
 Receptors ..... 811.2, Table 14-1  
 Relief ..... 220.0, 805.0, 907.0, 1008.4  
 Required ..... 710.0, 901.0, 904.1  
 Required separately on every trap ..... 901.0, 902.1,  
 1002.1-2  
 Sizing ..... Table 7-3, 710.0, 904.0, 905.4, 908.0, 910.4  
 Special ..... Chapter 8, 909.0  
 Stack ..... 224.0, 311.4, 906.1, 907.0  
 Steam, exhaust ..... 810.0  
 Sump ..... 710.7, 710.10, 810.1, Table 8-1  
 System, definition ..... 224.0  
 Ten stories or more ..... 907.1  
 Termination ..... 510.6.2, 906.0  
 Undiminished through roof ..... 905.4, 907.1  
 Unit loading ..... Table 7-5  
 Vertical wet ..... see Wet Vent  
 Wet ..... see Wet Vent  
 Yoke ..... 227.0, 907.0  
 Vent connector ..... 510.10  
 Vent or vent flue ..... 502.0  
 Vertical pipe: ..... 224.0, 703.0, 704.2, 905.6, 908.2, 910.5  
   Unit loading length-drainage piping ..... Table 7-5  
   Piping, support of ..... 314.0  
   Vertical-to-horizontal drainage fittings ... 706.4, 905.2-3, 909.0  
   Vertical wet venting ..... see Wet Vent  
 Violation, notices of ..... 103.5.6.1  
 Vitriified clay ..... 701.1.3, 705.2.1, 811.2, Table 14-1

### - W -

Wall, extension through ..... 313.1, 514.3  
 Wall-hung fixtures, installation of .... 316.3.3, 408.2, 408.4-6  
 Wall-hung water closets, definition ..... 225.0  
 Wall, recess or channel in ..... 313.2  
 Wash racks, auto ..... 1011.0  
 Waste ..... Chapter 7  
   Chemical laboratory, photographic ..... 811.0  
   Cooling water ..... 801.0, 808.0  
   Combination ..... 205.0, 901.0, Appendix B  
   Continuous ..... 205.0, 405.3-4, Table 7-3  
   Detrimental or harmful ..... 306.1, 307.0, 811.1, 1009.1  
   Food, disposal unit ..... see Food waste disposal unit  
   Indirect ..... 211.0, Table 7-3, Chapter 8, 902.0  
   Industrial ... 211.0, 307.0, 811.1, 903.2.3, 1001.3, 1009.0,

## UNIFORM PLUMBING CODE

<p style="text-align: right; margin-right: 20px;">1010.0, 1014.0</p> <p>Liquid ... 214.0, 303.0, 304.0, 710.2, 811.1, 1006.0, 1009.1</p> <p>Pipe, definition ..... 218.0</p> <p style="padding-left: 20px;">Buildings over 10 stories ..... 907.1</p> <p style="padding-left: 20px;">For refrigerators ..... Table 7-3, 801.2</p> <p style="padding-left: 20px;">Indirect ..... 211.0, 801.0, 805.0</p> <p style="padding-left: 40px;">Accessibility ..... 804.1</p> <p style="padding-left: 40px;">Airbreak ..... 801.0</p> <p style="padding-left: 40px;">Airgap for ..... 801.0, 806.0</p> <p style="padding-left: 40px;">Installation of ..... 313.6, Table 4-1, 802.0, 803.0, 810.0</p> <p style="padding-left: 40px;">Material of, inside building ..... 701.0</p> <p style="padding-left: 40px;">Number of fixtures allowed on ..... Table 7-5</p> <p style="padding-left: 40px;">Size of ..... Tables 7-3 &amp; 7-5</p> <p>Pretreatment required ..... 811.1, 1011.1</p> <p>Receptor, prohibited location ..... 804.1</p> <p>Special, definition ..... 221.0</p> <p>Stack, definition ..... 221.0</p> <p>Water:</p> <p style="padding-left: 20px;">Additions to existing work ..... 101.5.1, 610.13(2)</p> <p style="padding-left: 20px;">Building supply ..... 604.1, 609.5, 610.0, Table 6-5</p> <p style="padding-left: 20px;">Conditioning ..... 225.0, 603.0, 611.4, 610.2</p> <p style="padding-left: 20px;">Distributing pipe, definition ..... 225.0</p> <p style="padding-left: 20px;">Distribution system ..... Chapter 6</p> <p style="padding-left: 20px;">Filter ..... 610.2</p> <p style="padding-left: 20px;">Hammer arrester, definition ..... 225.0</p> <p style="padding-left: 20px;">Main, definition ..... 225.0</p> <p style="padding-left: 20px;">Non-potable lines ..... 603.4.12, 610.13(6)</p> <p style="padding-left: 20px;">Piping:</p> <p style="padding-left: 40px;">Grounding ..... 604.8</p> <p style="padding-left: 60px;">In sewer trench ..... 315.0, 609.2, 720.0</p> <p style="padding-left: 60px;">Installation of ..... 313.6, 603.3.8, 604.8, 609.0, 610.0, 720.0</p> <p style="padding-left: 40px;">Material ..... 604.0, Table 14-1</p> <p style="padding-left: 40px;">Sizing ..... 610.0, Tables 6-4 &amp; 6-5</p> <p style="padding-left: 40px;">Test ..... 103.5.3</p> <p style="padding-left: 40px;">Potable ... 218.0, 316.1.3, 501.0, 602.0-603.0, 604.5, 604.7, 604.10, 607.0, 608.2, 610.1-2, 610.13(7)</p> <p style="padding-left: 20px;">Pressure:</p> <p style="padding-left: 40px;">Excessive ..... 608.2-6</p> <p style="padding-left: 40px;">Inadequate ..... 608.1</p> <p style="padding-left: 40px;">Loss ..... 610.0</p> <p style="padding-left: 40px;">Regulators and relief valves ..... 608.2-6</p> <p style="padding-left: 40px;">Private supply ..... 602.4, Table 6-4</p> <p style="padding-left: 40px;">Prohibited materials ..... 604.10</p> <p style="padding-left: 40px;">Protection of potable ..... 603.0</p> <p style="padding-left: 40px;">Required ..... 601.1, 610.3</p> <p style="padding-left: 40px;">Service, size ..... 610.0, Table 6-5, 6-4</p> <p style="padding-left: 40px;">Softener ..... 610.2, Table 14-1</p> <p style="padding-left: 20px;">Supply:</p> <p style="padding-left: 40px;">Cross-connectors ..... 601.1, 602.3, 603.4.11</p> <p style="padding-left: 40px;">Flushometer valves ..... see Flushometer valves</p> <p style="padding-left: 40px;">To fixtures ..... 610.0, Tables 6-4 &amp; 6-7</p> <p style="padding-left: 40px;">System, definition ..... 225.0</p> <p style="padding-left: 40px;">Supply tank ..... 603.4.2, 607.0, Table 14-1</p> <p style="padding-left: 40px;">Temperature-limiting device 505.5, 506.2, Table 14-1</p> <p style="padding-left: 40px;">Test ..... 103.5, 610.2</p> <p style="padding-left: 20px;">Unlawful:</p> <p style="padding-left: 40px;">Connections ..... 602.0</p> <p style="padding-left: 40px;">Devices ..... 602.3</p> <p style="padding-left: 40px;">Valves, control ..... 605.0</p> <p style="padding-left: 20px;">Water closets ..... 316.3.1, 401.1, 404.0, 406.1, 408.0, 601.1, 603.3.1-3, 610.3, 910.7, Tables 6-4 &amp; 7-3</p>	<p style="padding-left: 20px;">Combustion air for ..... 507.0</p> <p style="padding-left: 20px;">Definition ..... 502.14</p> <p style="padding-left: 20px;">Gas ..... 508.0, 1203.2</p> <p style="padding-left: 20px;">Oil-burning and other ..... 506.0, Table 14-1</p> <p style="padding-left: 20px;">Pressure-relief valve ..... 608.3-6</p> <p style="padding-left: 20px;">Prohibited location ..... 505.1</p> <p>Protection ..... 508.0</p> <p>Waterproofing:</p> <p style="padding-left: 20px;">Fixture setting ..... 316.3.1, 408.0</p> <p style="padding-left: 20px;">Flashings ..... 313.8, 906.5</p> <p style="padding-left: 20px;">Openings ..... 313.8, 906.5</p> <p>Water-sealed traps ..... see Traps</p> <p>Water softener ..... 610.2, Table 14-1</p> <p>Water test:</p> <p style="padding-left: 20px;">Building sewers ..... 103.5</p> <p style="padding-left: 20px;">Plumbing, drainage and vent system ..... 103.5, 712.0</p> <p>Water treatment device ..... see Water Conditioning</p> <p>Weep holes, sub-drain of shower stalls ..... 412.8</p> <p>Weight of flashing, lead ..... 701.3</p> <p>Weights and quality of materials ... Chapter 3, 604.0, 906.6, 1210.5, Table 14-1</p> <p>Welded lead joints ..... 705.1.3</p> <p>Welder, pipe, definition ..... 225.0</p> <p>Welding or brazing joints ..... 316.1.7, 705.1.3, Table 14-1</p> <p>Well, distance from sewage disposal ..... 721.1, Table 7-7</p> <p>Wet vent ..... 225.0, 316.2.2, 908.0, 910.6</p> <p>Whirlpool bathtub, definition ..... 225.0</p> <p>Window, termination of vents from ..... 906.2</p> <p>Wiped joints ..... 316.1.2, 705.2.4</p> <p>Wooden sinks and laundry trays ..... 406.3</p> <p>Work, concealed ..... 103.1.2, 103.5.1-2, 504.2, 1204.3.1-2,</p> <p>Work, existing ..... 101.4-5, 207.0</p> <p>Work, exposed, where required .... 103.1.2, 103.5.1-2, 504.2, 1204.3.1-2, 1211.3</p> <p>Working space ..... 511.0</p> <p>Workmanship ..... 310.0, 609.1, 1203.0</p> <p>Wrapping of pipe ..... 313.0, 609.3.1</p> <p>Wrought iron (galvanized) .... 316.1.2, 604.1, 604.1, 701.1.1 705.2.3-4, 707.1, 903.1, Table 14-1</p> <p>Wye connections ..... 405.4, 706.0, 707.6-7, 710.4, 719.4, 907.2, 909.0</p> <p style="text-align: center;">- X -</p> <p>X-ray darkrooms ..... 811.8</p> <p style="text-align: center;">- Y -</p> <p>Yard piping, gas ..... 1211.0</p> <p style="text-align: center;">- Z -</p> <p>Zinc alloy die cast components ..... 403.1</p>
---	---

# **Errata for the 2003 Uniform Plumbing Code™ (5th Printing)**

The following is a list of changes that we found after the third printing of the 2003 Uniform Plumbing Code. These changes may or may not apply to your code book. However, we do encourage you to check your code book with this list to ensure that all changes are updated. Thank you.

## **Chapter 13:**

Revise section 1322.5 Pressure Gauges to read section 1322.3.

## **Appendix I, IS 20:**

Example Pipe Size drawing:

Revise measurement: 2L/5 (15-1/4")

## **Index:**

Revise reference section 1013.0 to read 1015.0 under Disposal of...Food Waste.

# Errata for the 2003 Uniform Plumbing Code™ (4th Printing)

The following is a list of changes that we found after the third printing of the 2003 Uniform Plumbing Code. These changes may or may not apply to your code book. However, we do encourage you to check your code book with this list to ensure that all changes are updated. Thank you.

## **Chapter 5:**

Insert the following text after Section 511.0:

*(1) The maximum capacity of the vent system shall be determined using the NAT MAX column.*

*(2) The maximum capacity shall be determined as if the appliance were a fan-assisted appliance, using the FAN MIN column to determine the minimum capacity of the vent system. Where the corresponding FAN MIN, the vent configuration shall not be permitted and an alternative venting configuration shall be utilized.*

## **Chapter 14 Abbreviations in Table 14-1:**

Insert "Water Quality Association" contact information.

WQA            *Water Quality Association, 4151 Naperville Rd., Lisle, IL 60532, 708-505-0160.*

# Errata for the 2003 Uniform Plumbing Code™ (3rd Printing)

The following is a list of changes that we found after the third printing of the 2003 Uniform Plumbing Code. These changes may or may not apply to your code book. However, we do encourage you to check your code book with this list to ensure that all changes are updated. Thank you.

## **Chapter 1:**

Delete the first paragraph in Section 103.4.5.3. It should now read, *“The Authority Having Jurisdiction shall not authorize the refunding of any fee paid except upon written application filed by the original permittee not later than one hundred eighty (180) days after the date of fee payment.”*

## **Chapter 12:**

Section 1202 General should read, “The regulation of this chapter shall govern the installation of all fuel gas piping in or in connection with any building or structure or within the property lines of any premises up **to** 5 psi.....

Section 1217.2 (4), delete reference Table 12-7 in the sentence. It should now read, *“At the top of this column will be found the correct size of pipe.”*

## **Useful Tables:**

Page 420 header; delete Sections 1506.1 – 1507.4 on the left header:



# Errata for the 2003 Uniform Plumbing Code™ (2nd Printing)

The following is a list of changes that we found after the second printing of the 2003 Uniform Plumbing Code. These changes may or may not apply to your code book. However, we do encourage you to check your code book with this list to ensure that all changes are updated. Thank you.

## Chapter 2:

Revise PEX-AL-PEX to read, Cross-linked polyethylene–*aluminum*–cross-linked polyethylene.

## Chapter 6:

Table 6-2 Backflow Prevention Devices, Assemblies, and Methods: Align all “x” in the correct column (see below); footnote 2 should read, Installation *in pit* or vault requires previous approval by the Authority Having Jurisdiction.

**TABLE 6-2  
Backflow Prevention Devices, Assemblies, and Methods**

Device, Assembly, or Method	Degree of Hazard				Installation <sup>2,3</sup>
	Pollution (Low Hazard)		Contamination (High Hazard)		
	Back- Siphonage	Back- Pressure	Back- Siphonage	Back- Pressure	
Airgap	x		x		See Table 6-3 in this chapter
Atmospheric Vacuum Breaker	x		x		Upright position. No valve downstream. Minimum of six (6) inches (152 mm) or listed distance above all downstream piping and flood-level rim of receptor. <sup>4,5</sup>
Spill-Proof Pressure-Type Vacuum Breaker	x		x		Upright position. Minimum of six (6) inches (152 mm) or listed distance above all downstream piping and flood-level rim of receptor. <sup>3</sup>
Double Check Valve Backflow Preventer	x	x			Horizontal, unless otherwise listed. Requires one (1) foot (305 mm) minimum clearance at bottom for maintenance. May need platform/ladder for test and repair. Does not discharge water.
Pressure Vacuum Breaker	x		x		Upright position. May have valves downstream. Minimum of twelve (12) inches (305 mm) above all downstream piping and flood-level rim of receptor. May discharge water.
Reduced Pressure Principle Backflow Preventer	x	x	x	x	Horizontal unless otherwise listed. Requires one (1) foot (305 mm) minimum clearance at bottom for maintenance. May need platform ladder for test and repair. May discharge water.

<sup>1</sup> See description of devices and assemblies in this chapter.

<sup>2</sup> Installation in pit or vault requires previous approval by the Authority Having Jurisdiction.

<sup>3</sup> Refer to general and specific requirement for installation.

<sup>4</sup> Not to be subjected to operating pressure for more than 12 hours in any 24 hour period.

<sup>5</sup> For deck-mounted and equipment-mounted vacuum breaker, see Section 603.4.16.

## Chapter 12:

Equation 12-2 High-Pressure Formula: Revise the upstream and downstream pressure to read  $(P_1^2 - P_2^2) \cdot Y$ .

**Appendix A**

Table A-2: See changes below in *italic*

	Minimum Fixture Branch Pipe Size <sup>1,4</sup>	Private	Public	Assembly <sup>6</sup>
Water Closet, 1.6 GPF Flushometer Valve,	<i>1"</i>	<i>5.0</i>	<i>5.0</i>	<i>8.0</i>

# 2003 Uniform Plumbing Code Errata (Soft cover - 1st Printing)

## CHAPTER 3:

Section 311.4: Add the following sentence to the end of this section.

**Also, single stack drainage and venting systems, with unvented branch lines are prohibited.**

## CHAPTER 5:

Add "**Table 5-2 Deleted**" between sections 507.1.4 and 507.2.

Section 507.2: Revise reference 507.3.1 to read **507.3**.

Section 507.3.1: Revise this section to read **507.3** Indoor Opening Size and Location

Section 507.5.1 Indoor Openings: Revise reference to read **507.3**.

Add the following extracted text at the end of section 508.6.2:

**8.2.2 Clearance to Combustible Materials. Gas utilization equipment and their vent connectors shall be installed with clearances from combustible material so their operation will not create a hazard to persons or property. Minimum clearances between combustible walls and the back ad sides of various conventional types of equipment and their vent connectors are specified in Chapter 9 and 10. (Reference can be also be made to NFPA 211, Standard for Chimneys, Fireplaces, Vents, and Solid-Fuel-Burning Appliances)**

Section 510.6.2.1 (1): Delete reference Table 5-4.

Add "**Figure 5-4 Reserved**" between Sections 510.6.6 and 510.7.

511.0 Sizing of Category I Venting Systems.

Revise Section 511.1.1 to read 511.1.

Revise Section 511.1.2 to read 511.1.1

Revise Section 511.1.3 to read 511.1.2. Single appliance venting configurations with zero (0) lateral lengths in Table 5-9, 5-10, and 5-13 shall not have ~~no~~ elbows in the venting system. ....For each **additional** elbow up to and including 45 degrees, the maximum.....

Revise Section 511.1.4 to read 511.1.3.

Revise Section 511.1.5 to read 511.1.4.

Revise Section 511.1.6 to read 511.1.5.

Revise Section 511.1.7 to read 511.1.6. ....Corrugated metallic liner systems installed with bends or offsets shall have their maximum capacity further reduced in accordance with **511.1.2**.

Revise Section 511.1.8 to read 511.1.7.

Revise Section 511.1.9 to read 511.1.8.

Revise Section 511.1.10 to read 511.1.9.

Revise Section 511.1.11 to read 511.1.10.

Revise Section 511.1.12 to read 511.1.11.

Revise Section 511.1.13 to read 511.1.12.

Revise Section 511.1.14 to read 511.1.13.

Revise Section 511.1.15 to read 511.1.14.

Insert a new **Section 511.2 Additional Requirements to Multiple Appliance Vent Table 5-14 through 5-21(a) and Table Table 5-21(b)**.

Section 511.2.1: Add subtitle **Obstructions and Vent Dampers** for this section.

Delete reference (~~See NFPA 54 13.2.4~~) and (~~See NFPA 54 Section 13.2~~) in Figure G.1(k).

Delete reference (~~See NFPA 54 Sections 13.1 and 13.2~~) in Figure G.1(l).

Delete reference (~~See NFPA 54 13.2.13 through 13.2.16~~) in Figure G.1(n).

**Under G.2.4 Example 5(c): Common Venting into an Exterior masonry Chimney, Chimney Liner Requirement**, second paragraph,...delete reference ~~511.1.7~~ and replace it with **511.1.6**.

Delete reference ~~511.1.7~~ in Water Heater Vent Connector Diameter and replace it with **511.1.6**.

J.1 Example of Combustion Indoor and Outdoor Combustion and Ventilation Opening Design

Under #6: Delete Section ~~507.3.1~~ and replace it with **507.3**.

## CHAPTER 12:

Under Section 1211.2.7 Removal of Pipe, replace (See Section ~~1214.2.0~~) with **1214.7.1**.

Under Section 1211.4.1 Change reference ~~1209.7.4~~ to **1209.7.5**.

## CHAPTER 14:

Delete standard ~~ANSI A106.6-77 Silver Brazing Joints for Wrought and Cast Bronze Solder Joint Fittings~~.

Under standard ASME A112.18.3-96 delete ~~Performance Requirements for Backflow Protection Devices and Systems in PLumbing Fixture Fittings~~

Under standard ASTM E 84-2001 delete ~~Standard Test Method for Surface Burning Characteristics of Building Materials~~

Under standard ASTM E 119-2000a delete ~~Standard Test Method for Fire Tests of Building Construction and Materials~~

Under standard ASTM E 814-2000 delete ~~Standard Test Method for Fire Tests of Through-Penetration Fire Stops~~

Revise the title for Standard IAPMO PS 2-2000a to **Cast Brass and Tubing P-Trads**

## APPENDIX A

Under A7 Example, second paragraph of A 7.1, please revise measurements to the following:

If the pipe material and water supply are such that Chart A-5 applies, the required diameter of the building supply is **three and half (3-1/2)inches (88.9 mm)** and the required diameter of the branch to the hot-water heater is one and one half (1-1/2) inches (40 mm).